



**FUNDAMENTALS OF ENGINEERING
SUPPLIED-REFERENCE HANDBOOK**

FIFTH EDITION

NATIONAL COUNCIL OF EXAMINERS
FOR ENGINEERING AND SURVEYING

© 2001 by the National Council of Examiners for Engineering and Surveying®.

FUNDAMENTALS OF ENGINEERING
SUPPLIED-REFERENCE HANDBOOK
FIFTH EDITION

Prepared by
National Council of Examiners for Engineering and Surveying® (NCEES®)
280 Seneca Creek Road
P.O. Box 1686
Clemson, SC 29633-1686
Telephone: (800) 250-3196
Fax: (864) 654-6033
www.ncees.org

© 2001 by the National Council of Examiners for Engineering and Surveying® .

All rights reserved. First edition 1996

Fifth edition 2001

FOREWORD

During its August 1991 Annual Business Meeting, the National Council of Examiners for Engineering and Surveying (NCEES) voted to make the Fundamentals of Engineering (FE) examination an NCEES supplied-reference examination. Then during its August 1994 Annual Business Meeting, the NCEES voted to make the FE examination a discipline-specific examination. As a result of the 1994 vote, the FE examination was developed to test the lower-division subjects of a typical bachelor engineering degree program during the morning portion of the examination, and to test the upper-division subjects of a typical bachelor engineering degree program during the afternoon. The lower-division subjects refer to the first 90 semester credit hours (five semesters at 18 credit hours per semester) of engineering coursework. The upper-division subjects refer to the remainder of the engineering coursework.

Since engineers rely heavily on reference materials, the *FE Supplied-Reference Handbook* will be made available prior to the examination. The examinee may use this handbook while preparing for the examination. The handbook contains only reference formulas and tables; no example questions are included. Many commercially available books contain worked examples and sample questions. An examinee can also perform a self-test using one of the NCEES *FE Sample Questions and Solutions* books (a partial examination), which may be purchased by calling (800) 250-3196.

The examinee is not allowed to bring reference material into the examination room. Another copy of the *FE Supplied-Reference Handbook* will be made available to each examinee in the room. When the examinee departs the examination room, the *FE Supplied-Reference Handbook* supplied in the room shall be returned to the examination proctors.

The *FE Supplied-Reference Handbook* has been prepared to support the FE examination process. The *FE Supplied-Reference Handbook* is not designed to assist in all parts of the FE examination. For example, some of the basic theories, conversions, formulas, and definitions that examinees are expected to know have not been included. The *FE Supplied-Reference Handbook* may not include some special material required for the solution of a particular question. In such a situation, the required special information will be included in the question statement.

DISCLAIMER: *The NCEES in no event shall be liable for not providing reference material to support all the questions in the FE examination. In the interest of constant improvement, the NCEES reserves the right to revise and update the FE Supplied-Reference Handbook as it deems appropriate without informing interested parties. Each NCEES FE examination will be administered using the latest version of the FE Supplied-Reference Handbook.*

So that this handbook can be reused, PLEASE, at the examination site,
DO NOT WRITE IN THIS HANDBOOK.

TABLE OF CONTENTS

UNITS	1
CONVERSION FACTORS	2
MATHEMATICS.....	3
STATICS.....	22
DYNAMICS	24
MECHANICS OF MATERIALS	33
FLUID MECHANICS.....	38
THERMODYNAMICS	47
HEAT TRANSFER	58
TRANSPORT PHENOMENA.....	63
CHEMISTRY	64
MATERIALS SCIENCE/STRUCTURE OF MATTER	68
ELECTRIC CIRCUITS	72
COMPUTERS, MEASUREMENT, AND CONTROLS.....	76
ENGINEERING ECONOMICS.....	79
ETHICS	86
CHEMICAL ENGINEERING.....	88
CIVIL ENGINEERING	92
ENVIRONMENTAL ENGINEERING	117
ELECTRICAL AND COMPUTER ENGINEERING	134
INDUSTRIAL ENGINEERING.....	143
MECHANICAL ENGINEERING	155
INDEX.....	166

UNITS

This handbook uses the metric system of units. Ultimately, the FE examination will be entirely metric. However, currently some of the problems use both metric and U.S. Customary System (USCS). In the USCS system of units, both force and mass are called pounds. Therefore, one must distinguish the pound-force (lbf) from the pound-mass (lbm).

The pound-force is that force which accelerates one pound-mass at 32.174 ft/s^2 . Thus, $1 \text{ lbf} = 32.174 \text{ lbm}\cdot\text{ft/s}^2$. The expression $32.174 \text{ lbm}\cdot\text{ft}/(\text{lbf}\cdot\text{s}^2)$ is designated as g_c and is used to resolve expressions involving both mass and force expressed as pounds. For instance, in writing Newton's second law, the equation would be written as $F = ma/g_c$, where F is in lbf, m in lbm, and a is in ft/s^2 .

Similar expressions exist for other quantities. Kinetic Energy: $KE = mv^2/2g_c$, with KE in (ft-lbf); Potential Energy: $PE = mgh/g_c$, with PE in (ft-lbf); Fluid Pressure: $p = \rho gh/g_c$, with p in (lbf/ft^2); Specific Weight: $SW = \rho g/g_c$, in (lbf/ft^3); Shear Stress: $\tau = (\mu/g_c)(dv/dy)$, with shear stress in (lbf/ft^2). In all these examples, g_c should be regarded as a unit conversion factor. It is frequently not written explicitly in engineering equations. However, its use is required to produce a consistent set of units.

Note that the conversion factor g_c [$\text{lbm}\cdot\text{ft}/(\text{lbf}\cdot\text{s}^2)$] should not be confused with the local acceleration of gravity g , which has different units (m/s^2) and may be either its standard value (9.807 m/s^2) or some other local value.

If the problem is presented in USCS units, it may be necessary to use the constant g_c in the equation to have a consistent set of units.

METRIC PREFIXES			COMMONLY USED EQUIVALENTS	
Multiple	Prefix	Symbol		
10^{-18}	atto	a	1 gallon of water weighs	8.34 lbf
10^{-15}	femto	f	1 cubic foot of water weighs	62.4 lbf
10^{-12}	pico	p	1 cubic inch of mercury weighs	0.491 lbf
10^{-9}	nano	n	The mass of one cubic meter of water is 1,000 kilograms	
10^{-6}	micro	μ		
10^{-3}	milli	m	TEMPERATURE CONVERSIONS	
10^{-2}	centi	c	$^{\circ}\text{F} = 1.8 (^{\circ}\text{C}) + 32$	
10^{-1}	deci	d	$^{\circ}\text{C} = (^{\circ}\text{F} - 32)/1.8$	
10^1	deka	da	$^{\circ}\text{R} = ^{\circ}\text{F} + 459.69$	
10^2	hecto	h	$\text{K} = ^{\circ}\text{C} + 273.15$	
10^3	kilo	k		
10^6	mega	M		
10^9	giga	G		
10^{12}	tera	T		
10^{15}	peta	P		
10^{18}	exa	E		

FUNDAMENTAL CONSTANTS

<u>Quantity</u>		<u>Symbol</u>	<u>Value</u>	<u>Units</u>
electron charge		e	1.6022×10^{-19}	C (coulombs)
Faraday constant		\mathcal{F}	96,485	coulombs/(mol)
gas constant	metric	\bar{R}	8,314	J/(kmol·K)
gas constant	metric	\bar{R}	8.314	$\text{kPa}\cdot\text{m}^3/(\text{kmol}\cdot\text{K})$
gas constant	USCS	\bar{R}	1,545	$\text{ft}\cdot\text{lbf}/(\text{lb mole}\cdot^{\circ}\text{R})$
		\bar{R}	0.08206	L-atm/mole-K
gravitation - newtonian constant		G	6.673×10^{-11}	$\text{m}^3/(\text{kg}\cdot\text{s}^2)$
gravitation - newtonian constant		G	6.673×10^{-11}	$\text{N}\cdot\text{m}^2/\text{kg}^2$
gravity acceleration (standard)	metric	g	9.807	m/s^2
gravity acceleration (standard)	USCS	g	32.174	ft/s^2
molar volume (ideal gas), $T = 273.15\text{K}$, $p = 101.3 \text{ kPa}$		V_m	22,414	L/kmol
speed of light in vacuum		c	299,792,000	m/s

CONVERSION FACTORS

Multiply	By	To Obtain	Multiply	By	To Obtain
acre	43,560	square feet (ft ²)	joule (J)	9.478×10^{-4}	Btu
ampere-hr (A-hr)	3,600	coulomb (C)	J	0.7376	ft-lbf
ångström (Å)	1×10^{-10}	meter (m)	J	1	newton-m (N·m)
atmosphere (atm)	76.0	cm, mercury (Hg)	J/s	1	watt (W)
atm, std	29.92	in, mercury (Hg)			
atm, std	14.70	lbf/in ² abs (psia)	kilogram (kg)	2.205	pound (lbm)
atm, std	33.90	ft, water	kgf	9.8066	newton (N)
atm, std	1.013×10^5	pascal (Pa)	kilometer (km)	3,281	feet (ft)
			km/hr	0.621	mph
bar	1×10^5	Pa	kilopascal (kPa)	0.145	lbf/in ² (psi)
barrels-oil	42	gallons-oil	kilowatt (kW)	1.341	horsepower (hp)
Btu	1,055	joule (J)	kW	3,413	Btu/hr
Btu	2.928×10^{-4}	kilowatt-hr (kWh)	kW	737.6	(ft-lbf)/sec
Btu	778	ft-lbf	kW-hour (kWh)	3,413	Btu
Btu/hr	3.930×10^{-4}	horsepower (hp)	kWh	1.341	hp-hr
Btu/hr	0.293	watt (W)	kWh	3.6×10^6	joule (J)
Btu/hr	0.216	ft-lbf/sec	kip (K)	1,000	lbf
			K	4,448	newton (N)
calorie (g-cal)	3.968×10^{-3}	Btu			
cal	1.560×10^{-6}	hp-hr	liter (L)	61.02	in ³
cal	4.186	joule (J)	L	0.264	gal (US Liq)
cal/sec	4.186	watt (W)	L	10^{-3}	m ³
centimeter (cm)	3.281×10^{-2}	foot (ft)	L/second (L/s)	2.119	ft ³ /min (cfm)
cm	0.394	inch (in)	L/s	15.85	gal (US)/min (gpm)
centipoise (cP)	0.001	pascal-sec (Pa·s)			
centistokes (cSt)	1×10^{-6}	m ² /sec (m ² /s)	meter (m)	3.281	feet (ft)
cubic feet/second (cfs)	0.646317	million gallons/day (mgd)	m	1.094	yard
cubic foot (ft ³)	7.481	gallon	m/second (m/s)	196.8	feet/min (ft/min)
cubic meters (m ³)	1,000	Liters	mile (statute)	5,280	feet (ft)
electronvolt (eV)	1.602×10^{-19}	joule (J)	mile (statute)	1.609	kilometer (km)
			mile/hour (mph)	88.0	ft/min (fpm)
foot (ft)	30.48	cm	mph	1.609	km/h
ft	0.3048	meter (m)	mm of Hg	1.316×10^{-3}	atm
ft-pound (ft-lbf)	1.285×10^{-3}	Btu	mm of H ₂ O	9.678×10^{-5}	atm
ft-lbf	3.766×10^{-7}	kilowatt-hr (kWh)			
ft-lbf	0.324	calorie (g-cal)	newton (N)	0.225	lbf
ft-lbf	1.356	joule (J)	N·m	0.7376	ft-lbf
ft-lbf/sec	1.818×10^{-3}	horsepower (hp)	N·m	1	joule (J)
gallon (US Liq)	3.785	liter (L)	pascal (Pa)	9.869×10^{-6}	atmosphere (atm)
gallon (US Liq)	0.134	ft ³	Pa	1	newton/m ² (N/m ²)
gallons of water	8.3453	pounds of water	Pa-sec (Pa·s)	10	poise (P)
gamma (γ, Γ)	1×10^{-9}	tesla (T)	pound (lbm, avdp)	0.454	kilogram (kg)
gauss	1×10^{-4}	T	lbf	4.448	N
gram (g)	2.205×10^{-3}	pound (lbm)	lbf-ft	1.356	N·m
			lbf/in ² (psi)	0.068	atm
hectare	1×10^4	square meters (m ²)	psi	2.307	ft of H ₂ O
hectare	2.47104	acres	psi	2.036	in of Hg
horsepower (hp)	42.4	Btu/min	psi	6,895	Pa
hp	745.7	watt (W)			
hp	33,000	(ft-lbf)/min	radian	$180/\pi$	degree
hp	550	(ft-lbf)/sec			
hp-hr	2,544	Btu	stokes	1×10^{-4}	m ² /s
hp-hr	1.98×10^6	ft-lbf			
hp-hr	2.68×10^6	joule (J)	therm	1×10^5	Btu
hp-hr	0.746	kWh			
			watt (W)	3.413	Btu/hr
inch (in)	2.540	centimeter (cm)	W	1.341×10^{-3}	horsepower (hp)
in of Hg	0.0334	atm	W	1	joule/sec (J/s)
in of Hg	13.60	in of H ₂ O	weber/m ² (Wb/m ²)	10,000	gauss
in of H ₂ O	0.0361	lbf/in ² (psi)			
in of H ₂ O	0.002458	atm			

MATHEMATICS

STRAIGHT LINE

The general form of the equation is

$$Ax + By + C = 0$$

The standard form of the equation is

$$y = mx + b,$$

which is also known as the *slope-intercept* form.

The *point-slope* form is $y - y_1 = m(x - x_1)$

Given two points: slope, $m = (y_2 - y_1)/(x_2 - x_1)$

The angle between lines with slopes m_1 and m_2 is

$$\alpha = \arctan [(m_2 - m_1)/(1 + m_2 \cdot m_1)]$$

Two lines are perpendicular if $m_1 = -1/m_2$

The distance between two points is

$$d = \sqrt{(y_2 - y_1)^2 + (x_2 - x_1)^2}$$

QUADRATIC EQUATION

$$ax^2 + bx + c = 0$$

$$\text{Roots} = \frac{-b \pm \sqrt{b^2 - 4ac}}{2a}$$

CONIC SECTIONS

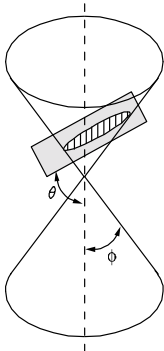

$$e = \text{eccentricity} = \cos \theta / (\cos \phi)$$

[Note: X' and Y' , in the following cases, are translated axes.]

Case 1. Parabola $e = 1$:

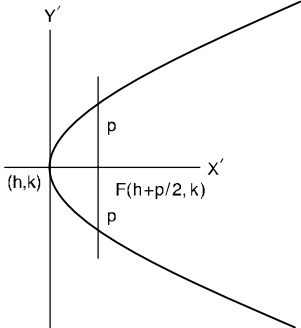

$$(y - k)^2 = 2p(x - h); \text{ Center at } (h, k)$$

is the standard form of the equation. When $h = k = 0$,
Focus: $(p/2, 0)$; Directrix: $x = -p/2$

Case 2. Ellipse $e < 1$:

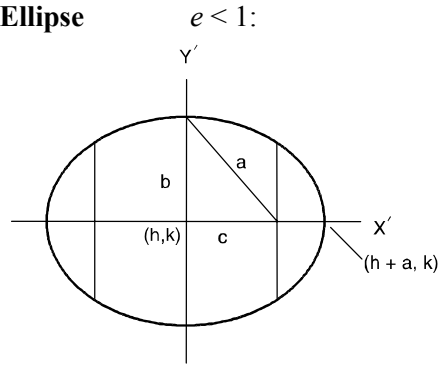

$$\frac{(x - h)^2}{a^2} + \frac{(y - k)^2}{b^2} = 1; \text{ Center at } (h, k)$$

is the standard form of the equation. When $h = k = 0$,

Eccentricity: $e = \sqrt{1 - (b^2/a^2)} = c/a$

$$b = a\sqrt{1 - e^2};$$

Focus: $(\pm ae, 0)$; Directrix: $x = \pm a/e$

Case 3. Hyperbola $e > 1$:

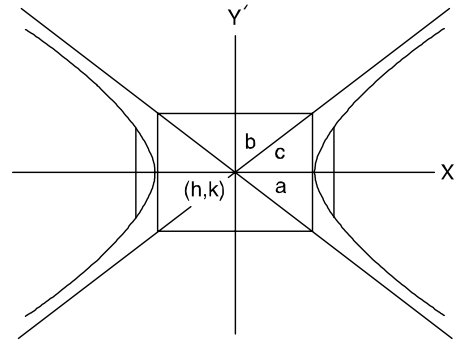

$$\frac{(x - h)^2}{a^2} - \frac{(y - k)^2}{b^2} = 1; \text{ Center at } (h, k)$$

is the standard form of the equation. When $h = k = 0$,

Eccentricity: $e = \sqrt{1 + (b^2/a^2)} = c/a$

$$b = a\sqrt{e^2 - 1};$$

Focus: $(\pm ae, 0)$; Directrix: $x = \pm a/e$

©Brink, R.W., *A First Year of College Mathematics*, Copyright © 1937 by D. Appleton-Century Co., Inc. Reprinted by permission of Prentice-Hall, Inc., Englewood Cliffs, NJ.

Case 4. Circle $e = 0$:

$$(x - h)^2 + (y - k)^2 = r^2; \quad \text{Center at } (h, k)$$

is the general form of the equation with radius

$$r = \sqrt{(x - h)^2 + (y - k)^2}$$

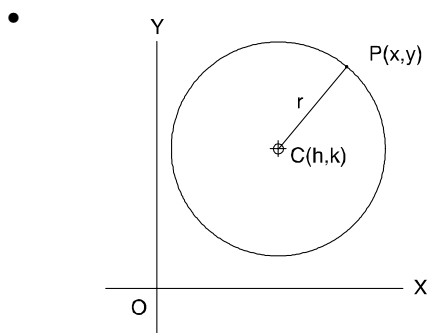

Length of the tangent from a point. Using the general form of the equation of a circle, the length of the tangent is found from

$$t^2 = (x' - h)^2 + (y' - k)^2 - r^2$$

by substituting the coordinates of a point $P(x', y')$ and the coordinates of the center of the circle into the equation and computing.

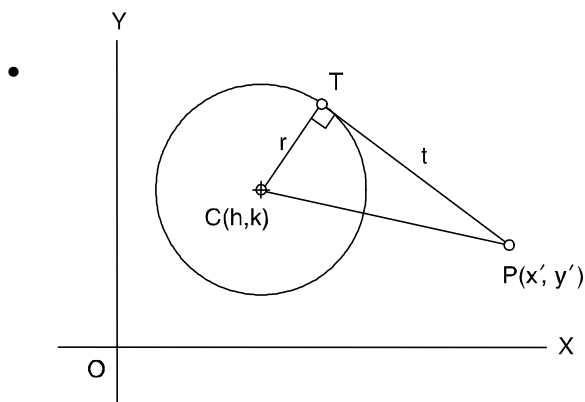

Conic Section Equation

The general form of the conic section equation is

$$Ax^2 + 2Bxy + Cy^2 + 2Dx + 2Ey + F = 0$$

where not both A and C are zero.

If $B^2 - AC < 0$, an *ellipse* is defined.

If $B^2 - AC > 0$, a *hyperbola* is defined.

If $B^2 - AC = 0$, the conic is a *parabola*.

If $A = C$ and $B = 0$, a *circle* is defined.

If $A = B = C = 0$, a *straight line* is defined.

$$x^2 + y^2 + 2ax + 2by + c = 0$$

is the normal form of the conic section equation, if that conic section has a principal axis parallel to a coordinate axis.

$$h = -a; k = -b$$

$$r = \sqrt{a^2 + b^2 - c}$$

If $a^2 + b^2 - c$ is positive, a *circle*, center $(-a, -b)$.

If $a^2 + b^2 - c$ equals zero, a *point* at $(-a, -b)$.

If $a^2 + b^2 - c$ is negative, locus is *imaginary*.

QUADRIC SURFACE (SPHERE)

The general form of the equation is

$$(x - h)^2 + (y - k)^2 + (z - m)^2 = r^2$$

with center at (h, k, m) .

In a three-dimensional space, the distance between two points is

$$d = \sqrt{(x_2 - x_1)^2 + (y_2 - y_1)^2 + (z_2 - z_1)^2}$$

LOGARITHMS

The logarithm of x to the Base b is defined by

$$\log_b(x) = c, \text{ where } b^c = x$$

Special definitions for $b = e$ or $b = 10$ are:

$$\ln x, \text{ Base } = e$$

$$\log x, \text{ Base } = 10$$

To change from one Base to another:

$$\log_b x = (\log_a x) / (\log_a b)$$

$$\text{e.g., } \ln x = (\log_{10} x) / (\log_{10} e) = 2.302585 (\log_{10} x)$$

Identities

$$\log_b b^n = n$$

$$\log x^c = c \log x; x^c = \text{antilog } (c \log x)$$

$$\log xy = \log x + \log y$$

$$\log_b b = 1; \log 1 = 0$$

$$\log x/y = \log x - \log y$$

• Brink, R.W., *A First Year of College Mathematics*, Copyright © 1937 by D. Appleton-Century Co., Inc. Reprinted by permission of Prentice-Hall, Inc., Englewood Cliffs, NJ.

TRIGONOMETRY

Trigonometric functions are defined using a right triangle.

$$\sin \theta = y/r, \cos \theta = x/r$$

$$\tan \theta = y/x, \cot \theta = x/y$$

$$\csc \theta = r/y, \sec \theta = r/x$$

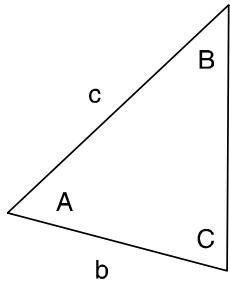
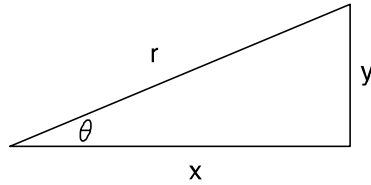

Law of Sines $\frac{a}{\sin A} = \frac{b}{\sin B} = \frac{c}{\sin C}$

Law of Cosines

$$a^2 = b^2 + c^2 - 2bc \cos A$$

$$b^2 = a^2 + c^2 - 2ac \cos B$$

$$c^2 = a^2 + b^2 - 2ab \cos C$$

Identities

$$\csc \theta = 1/\sin \theta$$

$$\sec \theta = 1/\cos \theta$$

$$\tan \theta = \sin \theta/\cos \theta$$

$$\cot \theta = 1/\tan \theta$$

$$\sin^2 \theta + \cos^2 \theta = 1$$

$$\tan^2 \theta + 1 = \sec^2 \theta$$

$$\cot^2 \theta + 1 = \csc^2 \theta$$

$$\sin(\alpha + \beta) = \sin \alpha \cos \beta + \cos \alpha \sin \beta$$

$$\cos(\alpha + \beta) = \cos \alpha \cos \beta - \sin \alpha \sin \beta$$

$$\sin 2\alpha = 2 \sin \alpha \cos \alpha$$

$$\cos 2\alpha = \cos^2 \alpha - \sin^2 \alpha = 1 - 2 \sin^2 \alpha = 2 \cos^2 \alpha - 1$$

$$\tan 2\alpha = (2 \tan \alpha)/(1 - \tan^2 \alpha)$$

$$\cot 2\alpha = (\cot^2 \alpha - 1)/(2 \cot \alpha)$$

$$\tan(\alpha + \beta) = (\tan \alpha + \tan \beta)/(1 - \tan \alpha \tan \beta)$$

$$\cot(\alpha + \beta) = (\cot \alpha \cot \beta - 1)/(\cot \alpha + \cot \beta)$$

$$\sin(\alpha - \beta) = \sin \alpha \cos \beta - \cos \alpha \sin \beta$$

$$\cos(\alpha - \beta) = \cos \alpha \cos \beta + \sin \alpha \sin \beta$$

$$\tan(\alpha - \beta) = (\tan \alpha - \tan \beta)/(1 + \tan \alpha \tan \beta)$$

$$\cot(\alpha - \beta) = (\cot \alpha \cot \beta + 1)/(\cot \beta - \cot \alpha)$$

$$\sin(\alpha/2) = \pm \sqrt{(1 - \cos \alpha)/2}$$

$$\cos(\alpha/2) = \pm \sqrt{(1 + \cos \alpha)/2}$$

$$\tan(\alpha/2) = \pm \sqrt{(1 - \cos \alpha)/(1 + \cos \alpha)}$$

$$\cot(\alpha/2) = \pm \sqrt{(1 + \cos \alpha)/(1 - \cos \alpha)}$$

$$\sin \alpha \sin \beta = (1/2)[\cos(\alpha - \beta) - \cos(\alpha + \beta)]$$

$$\cos \alpha \cos \beta = (1/2)[\cos(\alpha - \beta) + \cos(\alpha + \beta)]$$

$$\sin \alpha \cos \beta = (1/2)[\sin(\alpha + \beta) + \sin(\alpha - \beta)]$$

$$\sin \alpha + \sin \beta = 2 \sin(1/2)(\alpha + \beta) \cos(1/2)(\alpha - \beta)$$

$$\sin \alpha - \sin \beta = 2 \cos(1/2)(\alpha + \beta) \sin(1/2)(\alpha - \beta)$$

$$\cos \alpha + \cos \beta = 2 \cos(1/2)(\alpha + \beta) \cos(1/2)(\alpha - \beta)$$

$$\cos \alpha - \cos \beta = -2 \sin(1/2)(\alpha + \beta) \sin(1/2)(\alpha - \beta)$$

COMPLEX NUMBERS

Definition $i = \sqrt{-1}$

$$(a + ib) + (c + id) = (a + c) + i(b + d)$$

$$(a + ib) - (c + id) = (a - c) + i(b - d)$$

$$(a + ib)(c + id) = (ac - bd) + i(ad + bc)$$

$$\frac{a + ib}{c + id} = \frac{(a + ib)(c - id)}{(c + id)(c - id)} = \frac{(ac + bd) + i(bc - ad)}{c^2 + d^2}$$

$$(a + ib) + (a - ib) = 2a$$

$$(a + ib) - (a - ib) = 2ib$$

$$(a + ib)(a - ib) = a^2 + b^2$$

Polar Coordinates

$$x = r \cos \theta; y = r \sin \theta; \theta = \arctan(y/x)$$

$$r = |x + iy| = \sqrt{x^2 + y^2}$$

$$x + iy = r(\cos \theta + i \sin \theta) = re^{i\theta}$$

$$[r_1(\cos \theta_1 + i \sin \theta_1)][r_2(\cos \theta_2 + i \sin \theta_2)] =$$

$$r_1 r_2 [\cos(\theta_1 + \theta_2) + i \sin(\theta_1 + \theta_2)]$$

$$(x + iy)^n = [r(\cos \theta + i \sin \theta)]^n$$

$$= r^n (\cos n\theta + i \sin n\theta)$$

$$\frac{r_1(\cos \theta + i \sin \theta)}{r_2(\cos \theta_2 + i \sin \theta_2)} = \frac{r_1}{r_2} [\cos(\theta_1 - \theta_2) + i \sin(\theta_1 - \theta_2)]$$

Euler's Identity

$$e^{i\theta} = \cos \theta + i \sin \theta$$

$$e^{-i\theta} = \cos \theta - i \sin \theta$$

$$\cos \theta = \frac{e^{i\theta} + e^{-i\theta}}{2}, \quad \sin \theta = \frac{e^{i\theta} - e^{-i\theta}}{2i}$$

Roots

If k is any positive integer, any complex number (other than zero) has k distinct roots. The k roots of $r(\cos \theta + i \sin \theta)$ can be found by substituting successively $n = 0, 1, 2, \dots,$

$(k - 1)$ in the formula

$$w = \sqrt[k]{r} \left[\cos\left(\frac{\theta}{k} + n \frac{360^\circ}{k}\right) + i \sin\left(\frac{\theta}{k} + n \frac{360^\circ}{k}\right) \right]$$

MATRICES

A matrix is an ordered rectangular array of numbers with m rows and n columns. The element a_{ij} refers to row i and column j .

Multiplication

If $A = (a_{ik})$ is an $m \times n$ matrix and $B = (b_{kj})$ is an $n \times s$ matrix, the matrix product AB is an $m \times s$ matrix

$$C = (c_{ij}) = \left(\sum_{l=1}^n a_{il} b_{lj} \right)$$

where n is the common integer representing the number of columns of A and the number of rows of B (l and $k = 1, 2, \dots, n$).

Addition

If $A = (a_{ij})$ and $B = (b_{ij})$ are two matrices of the same size $m \times n$, the sum $A + B$ is the $m \times n$ matrix $C = (c_{ij})$ where $c_{ij} = a_{ij} + b_{ij}$.

Identity

The matrix $I = (a_{ij})$ is a square $n \times n$ identity matrix where $a_{ii} = 1$ for $i = 1, 2, \dots, n$ and $a_{ij} = 0$ for $i \neq j$.

Transpose

The matrix B is the transpose of the matrix A if each entry b_{ji} in B is the same as the entry a_{ij} in A and conversely. In equation form, the transpose is $B = A^T$.

Inverse

The inverse B of a square $n \times n$ matrix A is

$$B = A^{-1} = \frac{\text{adj}(A)}{|A|}, \text{ where}$$

$\text{adj}(A) =$ adjoint of A (obtained by replacing A^T elements with their cofactors, see **DETERMINANTS**) and

$|A| =$ determinant of A .

DETERMINANTS

A *determinant of order n* consists of n^2 numbers, called the *elements* of the determinant, arranged in n rows and n columns and enclosed by two vertical lines. In any determinant, the *minor* of a given element is the determinant that remains after all of the elements are struck out that lie in the same row and in the same column as the given element. Consider an element which lies in the h th column and the k th row. The *cofactor* of this element is the value of the minor of the element (if $h + k$ is *even*), and it is the negative of the value of the minor of the element (if $h + k$ is *odd*).

If n is greater than 1, the *value* of a determinant of order n is the sum of the n products formed by multiplying each element of some specified row (or column) by its cofactor. This sum is called the *expansion of the determinant* [according to the elements of the specified row (or column)]. For a second-order determinant:

$$\begin{vmatrix} a_1 & a_2 \\ b_1 & b_2 \end{vmatrix} = a_1 b_2 - a_2 b_1$$

For a third-order determinant:

$$\begin{vmatrix} a_1 & a_2 & a_3 \\ b_1 & b_2 & b_3 \\ c_1 & c_2 & c_3 \end{vmatrix} = a_1 b_2 c_3 + a_2 b_3 c_1 + a_3 b_1 c_2 - a_3 b_2 c_1 - a_2 b_1 c_3 - a_1 b_3 c_2$$

VECTORS

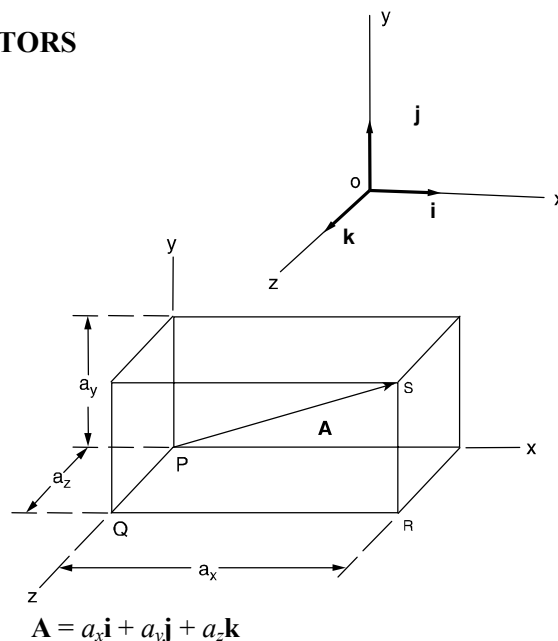

Addition and subtraction:

$$A + B = (a_x + b_x)\mathbf{i} + (a_y + b_y)\mathbf{j} + (a_z + b_z)\mathbf{k}$$

$$A - B = (a_x - b_x)\mathbf{i} + (a_y - b_y)\mathbf{j} + (a_z - b_z)\mathbf{k}$$

The *dot product* is a *scalar product* and represents the projection of B onto A times $|A|$. It is given by

$$\begin{aligned} A \cdot B &= a_x b_x + a_y b_y + a_z b_z \\ &= |A| |B| \cos \theta = B \cdot A \end{aligned}$$

The *cross product* is a *vector product* of magnitude $|B| |A| \sin \theta$ which is perpendicular to the plane containing A and B . The product is

$$A \times B = \begin{vmatrix} \mathbf{i} & \mathbf{j} & \mathbf{k} \\ a_x & a_y & a_z \\ b_x & b_y & b_z \end{vmatrix} = -B \times A$$

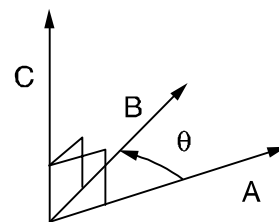

The sense of $A \times B$ is determined by the right-hand rule.

$$A \times B = |A| |B| \mathbf{n} \sin \theta, \text{ where}$$

$\mathbf{n} =$ unit vector perpendicular to the plane of A and B .

Gradient, Divergence, and Curl

$$\nabla\phi = \left(\frac{\partial}{\partial x}\mathbf{i} + \frac{\partial}{\partial y}\mathbf{j} + \frac{\partial}{\partial z}\mathbf{k}\right)\phi$$

$$\nabla \cdot \mathbf{V} = \left(\frac{\partial}{\partial x}\mathbf{i} + \frac{\partial}{\partial y}\mathbf{j} + \frac{\partial}{\partial z}\mathbf{k}\right) \cdot (V_1\mathbf{i} + V_2\mathbf{j} + V_3\mathbf{k})$$

$$\nabla \times \mathbf{V} = \left(\frac{\partial}{\partial x}\mathbf{i} + \frac{\partial}{\partial y}\mathbf{j} + \frac{\partial}{\partial z}\mathbf{k}\right) \times (V_1\mathbf{i} + V_2\mathbf{j} + V_3\mathbf{k})$$

The Laplacian of a scalar function ϕ is

$$\nabla^2\phi = \frac{\partial^2\phi}{\partial x^2} + \frac{\partial^2\phi}{\partial y^2} + \frac{\partial^2\phi}{\partial z^2}$$

Identities

$$\mathbf{A} \cdot \mathbf{B} = \mathbf{B} \cdot \mathbf{A}; \mathbf{A} \cdot (\mathbf{B} + \mathbf{C}) = \mathbf{A} \cdot \mathbf{B} + \mathbf{A} \cdot \mathbf{C}$$

$$\mathbf{A} \cdot \mathbf{A} = |\mathbf{A}|^2$$

$$\mathbf{i} \cdot \mathbf{i} = \mathbf{j} \cdot \mathbf{j} = \mathbf{k} \cdot \mathbf{k} = 1$$

$$\mathbf{i} \cdot \mathbf{j} = \mathbf{j} \cdot \mathbf{k} = \mathbf{k} \cdot \mathbf{i} = 0$$

If $\mathbf{A} \cdot \mathbf{B} = 0$, then either $\mathbf{A} = 0$, $\mathbf{B} = 0$, or \mathbf{A} is perpendicular to \mathbf{B} .

$$\mathbf{A} \times \mathbf{B} = -\mathbf{B} \times \mathbf{A}$$

$$\mathbf{A} \times (\mathbf{B} + \mathbf{C}) = (\mathbf{A} \times \mathbf{B}) + (\mathbf{A} \times \mathbf{C})$$

$$(\mathbf{B} + \mathbf{C}) \times \mathbf{A} = (\mathbf{B} \times \mathbf{A}) + (\mathbf{C} \times \mathbf{A})$$

$$\mathbf{i} \times \mathbf{i} = \mathbf{j} \times \mathbf{j} = \mathbf{k} \times \mathbf{k} = 0$$

$$\mathbf{i} \times \mathbf{j} = \mathbf{k} = -\mathbf{j} \times \mathbf{i}; \mathbf{j} \times \mathbf{k} = \mathbf{i} = -\mathbf{k} \times \mathbf{j}$$

$$\mathbf{k} \times \mathbf{i} = \mathbf{j} = -\mathbf{i} \times \mathbf{k}$$

If $\mathbf{A} \times \mathbf{B} = 0$, then either $\mathbf{A} = 0$, $\mathbf{B} = 0$, or \mathbf{A} is parallel to \mathbf{B} .

$$\nabla^2\phi = \nabla \cdot (\nabla\phi) = (\nabla \cdot \nabla)\phi$$

$$\nabla \times \nabla\phi = 0$$

$$\nabla \cdot (\nabla \times \mathbf{A}) = 0$$

$$\nabla \times (\nabla \times \mathbf{A}) = \nabla(\nabla \cdot \mathbf{A}) - \nabla^2\mathbf{A}$$

PROGRESSIONS AND SERIES

Arithmetic Progression

To determine whether a given finite sequence of numbers is an arithmetic progression, subtract each number from the following number. If the differences are equal, the series is arithmetic.

1. The first term is a .
2. The common difference is d .
3. The number of terms is n .
4. The last or n th term is l .
5. The sum of n terms is S .

$$l = a + (n - 1)d$$

$$S = n(a + l)/2 = n[2a + (n - 1)d]/2$$

Geometric Progression

To determine whether a given finite sequence is a geometric progression (G.P.), divide each number after the first by the preceding number. If the quotients are equal, the series is geometric.

1. The first term is a .
2. The common ratio is r .
3. The number of terms is n .
4. The last or n th term is l .
5. The sum of n terms is S .

$$l = ar^{n-1}$$

$$S = a(1 - r^n)/(1 - r); r \neq 1$$

$$S = (a - rl)/(1 - r); r \neq 1$$

$$\lim_{n \rightarrow \infty} S_n = a/(1 - r); r < 1$$

A G.P. converges if $|r| < 1$ and it diverges if $|r| \geq 1$.

Properties of Series

$$\sum_{i=1}^n c = nc; \quad c = \text{constant}$$

$$\sum_{i=1}^n cx_i = c \sum_{i=1}^n x_i$$

$$\sum_{i=1}^n (x_i + y_i - z_i) = \sum_{i=1}^n x_i + \sum_{i=1}^n y_i - \sum_{i=1}^n z_i$$

$$\sum_{x=1}^n x = (n + n^2)/2$$

1. A power series in x , or in $x - a$, which is convergent in the interval $-1 < x < 1$ (or $-1 < x - a < 1$), defines a function of x which is continuous for all values of x within the interval and is said to represent the function in that interval.
2. A power series may be differentiated term by term, and the resulting series has the same interval of convergence as the original series (except possibly at the end points of the interval).
3. A power series may be integrated term by term provided the limits of integration are within the interval of convergence of the series.
4. Two power series may be added, subtracted, or multiplied, and the resulting series in each case is convergent, at least, in the interval common to the two series.
5. Using the process of long division (as for polynomials), two power series may be divided one by the other.

Taylor's Series

$$f(x) = f(a) + \frac{f'(a)}{1!}(x-a) + \frac{f''(a)}{2!}(x-a)^2 + \dots + \frac{f^{(n)}(a)}{n!}(x-a)^n + \dots$$

is called *Taylor's series*, and the function $f(x)$ is said to be expanded about the point a in a Taylor's series.

If $a = 0$, the Taylor's series equation becomes a *Maclaurin's series*.

PROBABILITY AND STATISTICS

Permutations and Combinations

A *permutation* is a particular sequence of a given set of objects. A *combination* is the set itself without reference to order.

1. The number of different *permutations* of n distinct objects *taken r at a time* is

$$P(n, r) = \frac{n!}{(n-r)!}$$

2. The number of different *combinations* of n distinct objects *taken r at a time* is

$$C(n, r) = \frac{P(n, r)}{r!} = \frac{n!}{[r!(n-r)!]}$$

3. The number of different *permutations* of n objects *taken n at a time*, given that n_i are of type i , where $i = 1, 2, \dots, k$ and $\sum n_i = n$, is

$$P(n; n_1, n_2, \dots, n_k) = \frac{n!}{n_1! n_2! \dots n_k!}$$

Laws of Probability

Property 1. General Character of Probability

The probability $P(E)$ of an event E is a real number in the range of 0 to 1. The probability of an impossible event is 0 and that of an event certain to occur is 1.

Property 2. Law of Total Probability

$$P(A + B) = P(A) + P(B) - P(A, B), \text{ where}$$

$P(A + B)$ = the probability that either A or B occur alone or that both occur together,

$P(A)$ = the probability that A occurs,

$P(B)$ = the probability that B occurs, and

$P(A, B)$ = the probability that both A and B occur simultaneously.

Property 3. Law of Compound or Joint Probability

If neither $P(A)$ nor $P(B)$ is zero,

$$P(A, B) = P(A)P(B | A) = P(B)P(A | B), \text{ where}$$

$P(B | A)$ = the probability that B occurs given the fact that A has occurred, and

$P(A | B)$ = the probability that A occurs given the fact that B has occurred.

If either $P(A)$ or $P(B)$ is zero, then $P(A, B) = 0$.

Probability Functions

A random variable x has a probability associated with each of its values. The probability is termed a discrete probability if x can assume only the discrete values

$$x = X_1, X_2, \dots, X_i, \dots, X_N$$

The *discrete probability* of the event $X = x_i$ occurring is defined as $P(X_i)$.

Probability Density Functions

If x is continuous, then the *probability density function* $f(x)$ is defined so that

$$\int_{x_1}^{x_2} f(x) dx = \text{the probability that } x \text{ lies between } x_1 \text{ and } x_2.$$

The probability is determined by defining the equation for $f(x)$ and integrating between the values of x required.

Probability Distribution Functions

The *probability distribution function* $F(X_n)$ of the discrete probability function $P(X_i)$ is defined by

$$F(X_n) = \sum_{k=1}^n P(X_k) = P(X_i \leq X_n)$$

When x is continuous, the *probability distribution function* $F(x)$ is defined by

$$F(x) = \int_{-\infty}^x f(t) dt$$

which implies that $F(a)$ is the probability that $x \leq a$.

The *expected value* $g(x)$ of any function is defined as

$$E\{g(x)\} = \int_{-\infty}^x g(t)f(t) dt$$

Binomial Distribution

$P(x)$ is the probability that x will occur in n trials. If p = probability of success and q = probability of failure = $1 - p$, then

$$P(x) = C(n, x)p^x q^{n-x} = \frac{n!}{x!(n-x)!} p^x q^{n-x}, \text{ where}$$

x = 0, 1, 2, ..., n ,

$C(n, x)$ = the number of combinations, and

n, p = parameters.

Normal Distribution (Gaussian Distribution)

This is a unimodal distribution, the mode being $x = \mu$, with two points of inflection (each located at a distance σ to either side of the mode). The averages of n observations tend to become normally distributed as n increases. The variate x is said to be normally distributed if its density function $f(x)$ is given by an expression of the form

$$f(x) = \frac{1}{\sigma\sqrt{2\pi}} e^{-(x-\mu)^2/2\sigma^2}, \text{ where}$$

μ = the population mean,

σ = the standard deviation of the population, and

$$-\infty \leq x \leq \infty$$

When $\mu = 0$ and $\sigma^2 = \sigma = 1$, the distribution is called a *standardized* or *unit normal* distribution. Then

$$f(x) = \frac{1}{\sqrt{2\pi}} e^{-x^2/2}, \text{ where } -\infty \leq x \leq \infty.$$

A unit normal distribution table is included at the end of this section. In the table, the following notations are utilized:

$F(x)$ = the area under the curve from $-\infty$ to x ,

$R(x)$ = the area under the curve from x to ∞ , and

$W(x)$ = the area under the curve between $-x$ and x .

Dispersion, Mean, Median, and Mode Values

If X_1, X_2, \dots, X_n represent the values of n items or observations, the *arithmetic mean* of these items or observations, denoted \bar{X} , is defined as

$$\bar{X} = (1/n)(X_1 + X_2 + \dots + X_n) = (1/n)\sum_{i=1}^n X_i$$

$\bar{X} \rightarrow \mu$ for sufficiently large values of n .

The *weighted arithmetic mean* is

$$\bar{X}_w = \frac{\sum w_i X_i}{\sum w_i}, \text{ where}$$

\bar{X}_w = the weighted arithmetic mean,

X_i = the values of the observations to be averaged, and

w_i = the weight applied to the X_i value.

The *variance* of the observations is the *arithmetic mean* of the *squared deviations from the population mean*. In symbols, X_1, X_2, \dots, X_n represent the values of the n *sample* observations of a *population of size N*. If μ is the arithmetic mean of the population, the *population variance* is defined by

$$\begin{aligned} \sigma^2 &= (1/N)[(X_1 - \mu)^2 + (X_2 - \mu)^2 + \dots + (X_N - \mu)^2] \\ &= (1/N)\sum_{i=1}^N (X_i - \mu)^2 \end{aligned}$$

The *standard deviation* of a population is

$$\sigma = \sqrt{(1/N)\sum (X_i - \mu)^2}$$

The *sample variance* is

$$s^2 = [1/(n-1)]\sum_{i=1}^n (X_i - \bar{X})^2$$

The *sample standard deviation* is

$$s = \sqrt{\left[\frac{1}{n-1}\right]\sum_{i=1}^n (X_i - \bar{X})^2}$$

The *coefficient of variation* = $CV = s/\bar{X}$

The *geometric mean* = $\sqrt[n]{X_1 X_2 X_3 \dots X_n}$

The *root-mean-square value* = $\sqrt{(1/n)\sum X_i^2}$

The *median* is defined as the *value of the middle item* when the data are *rank-ordered* and the number of items is *odd*. The *median* is the *average of the middle two items* when the rank-ordered data consists of an *even* number of items.

The *mode* of a set of data is the *value that occurs with greatest frequency*.

t-Distribution

The variate t is defined as the quotient of two independent variates x and r where x is *unit normal* and r is the *root mean square* of n other independent *unit normal variates*; that is, $t = x/r$. The following is the t -distribution with n degrees of freedom:

$$f(t) = \frac{\Gamma[(n+1)/2]}{\Gamma(n/2)\sqrt{n\pi}} \frac{1}{(1+t^2/n)^{(n+1)/2}}$$

where $-\infty \leq t \leq \infty$.

A table at the end of this section gives the values of $t_{\alpha, n}$ for values of α and n . Note that in view of the symmetry of the t -distribution,

$t_{1-\alpha, n} = -t_{\alpha, n}$. The function for α follows:

$$\alpha = \int_{t_{\alpha, n}}^{\infty} f(t) dt$$

A table showing probability and density functions is included on page 149 in the **INDUSTRIAL ENGINEERING SECTION** of this handbook.

GAMMA FUNCTION

$$\Gamma(n) = \int_0^{\infty} t^{n-1} e^{-t} dt, \quad n > 0$$

CONFIDENCE INTERVALS

Confidence Interval for the Mean μ of a Normal Distribution

(a) Standard deviation σ is known

$$\bar{X} - Z_{\alpha/2} \frac{\sigma}{\sqrt{n}} \leq \mu \leq \bar{X} + Z_{\alpha/2} \frac{\sigma}{\sqrt{n}}$$

(b) Standard deviation σ is not known

$$\bar{X} - t_{\alpha/2} \frac{s}{\sqrt{n}} \leq \mu \leq \bar{X} + t_{\alpha/2} \frac{s}{\sqrt{n}}$$

where $t_{\alpha/2}$ corresponds to $n - 1$ degrees of freedom.

Confidence Interval for the Difference Between Two Means μ_1 and μ_2

(a) Standard deviations σ_1 and σ_2 known

$$\bar{X}_1 - \bar{X}_2 - Z_{\alpha/2} \sqrt{\frac{\sigma_1^2}{n_1} + \frac{\sigma_2^2}{n_2}} \leq \mu_1 - \mu_2 \leq \bar{X}_1 - \bar{X}_2 + Z_{\alpha/2} \sqrt{\frac{\sigma_1^2}{n_1} + \frac{\sigma_2^2}{n_2}}$$

(b) Standard deviations σ_1 and σ_2 are not known

$$\bar{X}_1 - \bar{X}_2 - t_{\alpha/2} \sqrt{\frac{\left(\frac{1}{n_1} + \frac{1}{n_2}\right) [(n_1 - 1)S_1^2 + (n_2 - 1)S_2^2]}{n_1 + n_2 - 2}} \leq \mu_1 - \mu_2 \leq \bar{X}_1 - \bar{X}_2 + t_{\alpha/2} \sqrt{\frac{\left(\frac{1}{n_1} + \frac{1}{n_2}\right) [(n_1 - 1)S_1^2 + (n_2 - 1)S_2^2]}{n_1 + n_2 - 2}}$$

where $t_{\alpha/2}$ corresponds to $n_1 + n_2 - 2$ degrees of freedom.

UNIT NORMAL DISTRIBUTION TABLE

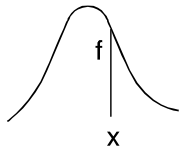
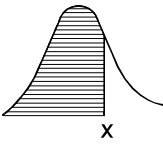
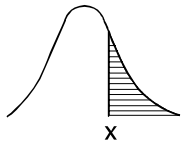
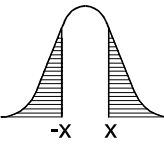
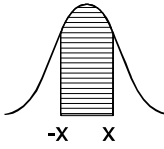
					
x	$f(x)$	$F(x)$	$R(x)$	$2R(x)$	$W(x)$
0.0	0.3989	0.5000	0.5000	1.0000	0.0000
0.1	0.3970	0.5398	0.4602	0.9203	0.0797
0.2	0.3910	0.5793	0.4207	0.8415	0.1585
0.3	0.3814	0.6179	0.3821	0.7642	0.2358
0.4	0.3683	0.6554	0.3446	0.6892	0.3108
0.5	0.3521	0.6915	0.3085	0.6171	0.3829
0.6	0.3332	0.7257	0.2743	0.5485	0.4515
0.7	0.3123	0.7580	0.2420	0.4839	0.5161
0.8	0.2897	0.7881	0.2119	0.4237	0.5763
0.9	0.2661	0.8159	0.1841	0.3681	0.6319
1.0	0.2420	0.8413	0.1587	0.3173	0.6827
1.1	0.2179	0.8643	0.1357	0.2713	0.7287
1.2	0.1942	0.8849	0.1151	0.2301	0.7699
1.3	0.1714	0.9032	0.0968	0.1936	0.8064
1.4	0.1497	0.9192	0.0808	0.1615	0.8385
1.5	0.1295	0.9332	0.0668	0.1336	0.8664
1.6	0.1109	0.9452	0.0548	0.1096	0.8904
1.7	0.0940	0.9554	0.0446	0.0891	0.9109
1.8	0.0790	0.9641	0.0359	0.0719	0.9281
1.9	0.0656	0.9713	0.0287	0.0574	0.9426
2.0	0.0540	0.9772	0.0228	0.0455	0.9545
2.1	0.0440	0.9821	0.0179	0.0357	0.9643
2.2	0.0355	0.9861	0.0139	0.0278	0.9722
2.3	0.0283	0.9893	0.0107	0.0214	0.9786
2.4	0.0224	0.9918	0.0082	0.0164	0.9836
2.5	0.0175	0.9938	0.0062	0.0124	0.9876
2.6	0.0136	0.9953	0.0047	0.0093	0.9907
2.7	0.0104	0.9965	0.0035	0.0069	0.9931
2.8	0.0079	0.9974	0.0026	0.0051	0.9949
2.9	0.0060	0.9981	0.0019	0.0037	0.9963
3.0	0.0044	0.9987	0.0013	0.0027	0.9973
Fractiles					
1.2816	0.1755	0.9000	0.1000	0.2000	0.8000
1.6449	0.1031	0.9500	0.0500	0.1000	0.9000
1.9600	0.0584	0.9750	0.0250	0.0500	0.9500
2.0537	0.0484	0.9800	0.0200	0.0400	0.9600
2.3263	0.0267	0.9900	0.0100	0.0200	0.9800
2.5758	0.0145	0.9950	0.0050	0.0100	0.9900

t-DISTRIBUTION TABLE

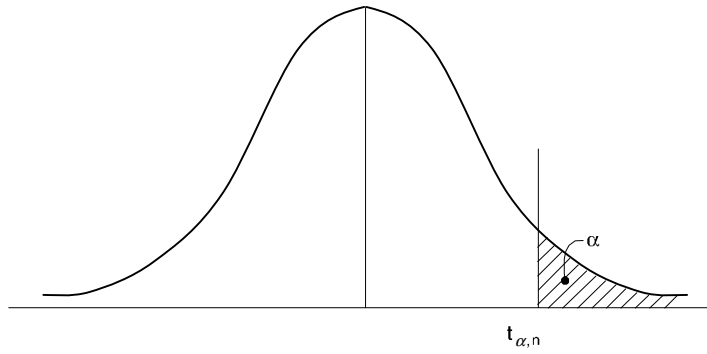

VALUES OF $t_{\alpha, n}$

n	$\alpha = 0.10$	$\alpha = 0.05$	$\alpha = 0.025$	$\alpha = 0.01$	$\alpha = 0.005$	n
1	3.078	6.314	12.706	31.821	63.657	1
2	1.886	2.920	4.303	6.965	9.925	2
3	1.638	2.353	3.182	4.541	5.841	3
4	1.533	2.132	2.776	3.747	4.604	4
5	1.476	2.015	2.571	3.365	4.032	5
6	1.440	1.943	2.447	3.143	3.707	6
7	1.415	1.895	2.365	2.998	3.499	7
8	1.397	1.860	2.306	2.896	3.355	8
9	1.383	1.833	2.262	2.821	3.250	9
10	1.372	1.812	2.228	2.764	3.169	10
11	1.363	1.796	2.201	2.718	3.106	11
12	1.356	1.782	2.179	2.681	3.055	12
13	1.350	1.771	2.160	2.650	3.012	13
14	1.345	1.761	2.145	2.624	2.977	14
15	1.341	1.753	2.131	2.602	2.947	15
16	1.337	1.746	2.120	2.583	2.921	16
17	1.333	1.740	2.110	2.567	2.898	17
18	1.330	1.734	2.101	2.552	2.878	18
19	1.328	1.729	2.093	2.539	2.861	19
20	1.325	1.725	2.086	2.528	2.845	20
21	1.323	1.721	2.080	2.518	2.831	21
22	1.321	1.717	2.074	2.508	2.819	22
23	1.319	1.714	2.069	2.500	2.807	23
24	1.318	1.711	2.064	2.492	2.797	24
25	1.316	1.708	2.060	2.485	2.787	25
26	1.315	1.706	2.056	2.479	2.779	26
27	1.314	1.703	2.052	2.473	2.771	27
28	1.313	1.701	2.048	2.467	2.763	28
29	1.311	1.699	2.045	2.462	2.756	29
inf.	1.282	1.645	1.960	2.326	2.576	inf.

CRITICAL VALUES OF THE F DISTRIBUTION – TABLE

For a particular combination of numerator and denominator degrees of freedom, entry represents the critical values of F corresponding to a specified upper tail area (α).

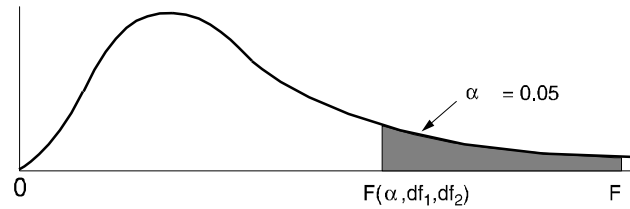

Denominator df_2	Numerator df_1																		
	1	2	3	4	5	6	7	8	9	10	12	15	20	24	30	40	60	120	∞
1	161.4	199.5	215.7	224.6	230.2	234.0	236.8	238.9	240.5	241.9	243.9	245.9	248.0	249.1	250.1	251.1	252.2	253.3	254.3
2	18.51	19.00	19.16	19.25	19.30	19.33	19.35	19.37	19.38	19.40	19.41	19.43	19.45	19.45	19.46	19.47	19.48	19.49	19.50
3	10.13	9.55	9.28	9.12	9.01	8.94	8.89	8.85	8.81	8.79	8.74	8.70	8.66	8.64	8.62	8.59	8.57	8.55	8.53
4	7.71	6.94	6.59	6.39	6.26	6.16	6.09	6.04	6.00	5.96	5.91	5.86	5.80	5.77	5.75	5.72	5.69	5.66	5.63
5	6.61	5.79	5.41	5.19	5.05	4.95	4.88	4.82	4.77	4.74	4.68	4.62	4.56	4.53	4.50	4.46	4.43	4.40	4.36
6	5.99	5.14	4.76	4.53	4.39	4.28	4.21	4.15	4.10	4.06	4.00	3.94	3.87	3.84	3.81	3.77	3.74	3.70	3.67
7	5.59	4.74	4.35	4.12	3.97	3.87	3.79	3.73	3.68	3.64	3.57	3.51	3.44	3.41	3.38	3.34	3.30	3.27	3.23
8	5.32	4.46	4.07	3.84	3.69	3.58	3.50	3.44	3.39	3.35	3.28	3.22	3.15	3.12	3.08	3.04	3.01	2.97	2.93
9	5.12	4.26	3.86	3.63	3.48	3.37	3.29	3.23	3.18	3.14	3.07	3.01	2.94	2.90	2.86	2.83	2.79	2.75	2.71
10	4.96	4.10	3.71	3.48	3.33	3.22	3.14	3.07	3.02	2.98	2.91	2.85	2.77	2.74	2.70	2.66	2.62	2.58	2.54
11	4.84	3.98	3.59	3.36	3.20	3.09	3.01	2.95	2.90	2.85	2.79	2.72	2.65	2.61	2.57	2.53	2.49	2.45	2.40
12	4.75	3.89	3.49	3.26	3.11	3.00	2.91	2.85	2.80	2.75	2.69	2.62	2.54	2.51	2.47	2.43	2.38	2.34	2.30
13	4.67	3.81	3.41	3.18	3.03	2.92	2.83	2.77	2.71	2.67	2.60	2.53	2.46	2.42	2.38	2.34	2.30	2.25	2.21
14	4.60	3.74	3.34	3.11	2.96	2.85	2.76	2.70	2.65	2.60	2.53	2.46	2.39	2.35	2.31	2.27	2.22	2.18	2.13
15	4.54	3.68	3.29	3.06	2.90	2.79	2.71	2.64	2.59	2.54	2.48	2.40	2.33	2.29	2.25	2.20	2.16	2.11	2.07
16	4.49	3.63	3.24	3.01	2.85	2.74	2.66	2.59	2.54	2.49	2.42	2.35	2.28	2.24	2.19	2.15	2.11	2.06	2.01
17	4.45	3.59	3.20	2.96	2.81	2.70	2.61	2.55	2.49	2.45	2.38	2.31	2.23	2.19	2.15	2.10	2.06	2.01	1.96
18	4.41	3.55	3.16	2.93	2.77	2.66	2.58	2.51	2.46	2.41	2.34	2.27	2.19	2.15	2.11	2.06	2.02	1.97	1.92
19	4.38	3.52	3.13	2.90	2.74	2.63	2.54	2.48	2.42	2.38	2.31	2.23	2.16	2.11	2.07	2.03	1.98	1.93	1.88
20	4.35	3.49	3.10	2.87	2.71	2.60	2.51	2.45	2.39	2.35	2.28	2.20	2.12	2.08	2.04	1.99	1.95	1.90	1.84
21	4.32	3.47	3.07	2.84	2.68	2.57	2.49	2.42	2.37	2.32	2.25	2.18	2.10	2.05	2.01	1.96	1.92	1.87	1.81
22	4.30	3.44	3.05	2.82	2.66	2.55	2.46	2.40	2.34	2.30	2.23	2.15	2.07	2.03	1.98	1.94	1.89	1.84	1.78
23	4.28	3.42	3.03	2.80	2.64	2.53	2.44	2.37	2.32	2.27	2.20	2.13	2.05	2.01	1.96	1.91	1.86	1.81	1.76
24	4.26	3.40	3.01	2.78	2.62	2.51	2.42	2.36	2.30	2.25	2.18	2.11	2.03	1.98	1.94	1.89	1.84	1.79	1.73
25	4.24	3.39	2.99	2.76	2.60	2.49	2.40	2.34	2.28	2.24	2.16	2.09	2.01	1.96	1.92	1.87	1.82	1.77	1.71
26	4.23	3.37	2.98	2.74	2.59	2.47	2.39	2.32	2.27	2.22	2.15	2.07	1.99	1.95	1.90	1.85	1.80	1.75	1.69
27	4.21	3.35	2.96	2.73	2.57	2.46	2.37	2.31	2.25	2.20	2.13	2.06	1.97	1.93	1.88	1.84	1.79	1.73	1.67
28	4.20	3.34	2.95	2.71	2.56	2.45	2.36	2.29	2.24	2.19	2.12	2.04	1.96	1.91	1.87	1.82	1.77	1.71	1.65
29	4.18	3.33	2.93	2.70	2.55	2.43	2.35	2.28	2.22	2.18	2.10	2.03	1.94	1.90	1.85	1.81	1.75	1.70	1.64
30	4.17	3.32	2.92	2.69	2.53	2.42	2.33	2.27	2.21	2.16	2.09	2.01	1.93	1.89	1.84	1.79	1.74	1.68	1.62
40	4.08	3.23	2.84	2.61	2.45	2.34	2.25	2.18	2.12	2.08	2.00	1.92	1.84	1.79	1.74	1.69	1.64	1.58	1.51
60	4.00	3.15	2.76	2.53	2.37	2.25	2.17	2.10	2.04	1.99	1.92	1.84	1.75	1.70	1.65	1.59	1.53	1.47	1.39
120	3.92	3.07	2.68	2.45	2.29	2.17	2.09	2.02	1.96	1.91	1.83	1.75	1.66	1.61	1.55	1.50	1.43	1.35	1.25
∞	3.84	3.00	2.60	2.37	2.21	2.10	2.01	1.94	1.88	1.83	1.75	1.67	1.57	1.52	1.46	1.39	1.32	1.22	1.00

DIFFERENTIAL CALCULUS

The Derivative

For any function $y = f(x)$,

the derivative $= D_x y = dy/dx = y'$

$$y' = \lim_{\Delta x \rightarrow 0} \left[\frac{\Delta y}{\Delta x} \right]$$

$$= \lim_{\Delta x \rightarrow 0} \left\{ \frac{[f(x + \Delta x) - f(x)]}{\Delta x} \right\}$$

y' = the slope of the curve $f(x)$.

Test for a Maximum

$y = f(x)$ is a maximum for
 $x = a$, if $f'(a) = 0$ and $f''(a) < 0$.

Test for a Minimum

$y = f(x)$ is a minimum for
 $x = a$, if $f'(a) = 0$ and $f''(a) > 0$.

Test for a Point of Inflection

$y = f(x)$ has a point of inflection at $x = a$,
 if $f''(a) = 0$, and
 if $f''(x)$ changes sign as x increases through
 $x = a$.

The Partial Derivative

In a function of two independent variables x and y , a derivative with respect to one of the variables may be found if the other variable is *assumed* to remain constant. If y is *kept fixed*, the function

$$z = f(x, y)$$

becomes a function of the *single variable* x , and its derivative (if it exists) can be found. This derivative is called the *partial derivative of z with respect to x* . The partial derivative with respect to x is denoted as follows:

$$\frac{\partial z}{\partial x} = \frac{\partial f(x, y)}{\partial x}$$

The Curvature of Any Curve

◆

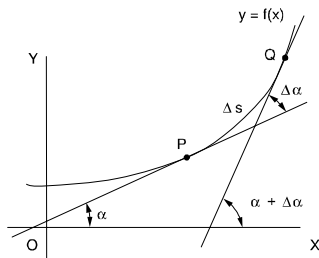

The curvature K of a curve at P is the limit of its average curvature for the arc PQ as Q approaches P . This is also expressed as: the curvature of a curve at a given point is the rate-of-change of its inclination with respect to its arc length.

$$K = \lim_{\Delta s \rightarrow 0} \frac{\Delta \alpha}{\Delta s} = \frac{d\alpha}{ds}$$

Curvature in Rectangular Coordinates

$$K = \frac{y''}{[1 + (y')^2]^{3/2}}$$

When it may be easier to differentiate the function with respect to y rather than x , the notation x' will be used for the derivative.

$$x' = dx/dy$$

$$K = \frac{-x''}{[1 + (x')^2]^{3/2}}$$

The Radius of Curvature

The *radius of curvature* R at any point on a curve is defined as the absolute value of the reciprocal of the curvature K at that point.

$$R = \frac{1}{|K|} \quad (K \neq 0)$$

$$R = \frac{[1 + (y')^2]^{3/2}}{|y''|} \quad (y'' \neq 0)$$

L'Hospital's Rule (L'Hôpital's Rule)

If the fractional function $f(x)/g(x)$ assumes one of the indeterminate forms $0/0$ or ∞/∞ (where α is finite or infinite), then

$$\lim_{x \rightarrow \alpha} f(x)/g(x)$$

is equal to the first of the expressions

$$\lim_{x \rightarrow \alpha} \frac{f'(x)}{g'(x)}, \lim_{x \rightarrow \alpha} \frac{f''(x)}{g''(x)}, \lim_{x \rightarrow \alpha} \frac{f'''(x)}{g'''(x)}$$

which is not indeterminate, provided such first indicated limit exists.

INTEGRAL CALCULUS

The definite integral is defined as:

$$\lim_{n \rightarrow \infty} \sum_{i=1}^n f(x_i) \Delta x_i = \int_a^b f(x) dx$$

Also, $\Delta x_i \rightarrow 0$ for all i .

A table of derivatives and integrals is available on page 15. The integral equations can be used along with the following methods of integration:

- A. Integration by Parts (integral equation #6),
- B. Integration by Substitution, and
- C. Separation of Rational Fractions into Partial Fractions.

◆ Wade, Thomas L., *Calculus*, Copyright © 1953 by Ginn & Company. Diagram reprinted by permission of Simon & Schuster Publishers.

DERIVATIVES AND INDEFINITE INTEGRALS

In these formulas, u , v , and w represent functions of x . Also, a , c , and n represent constants. All arguments of the trigonometric functions are in radians. A constant of integration should be added to the integrals. To avoid terminology difficulty, the following definitions are followed: $\arcsin u = \sin^{-1} u$, $(\sin u)^{-1} = 1/\sin u$.

- | | |
|---|---|
| <p>1. $dc/dx = 0$</p> <p>2. $dx/dx = 1$</p> <p>3. $d(cu)/dx = c du/dx$</p> <p>4. $d(u + v - w)/dx = du/dx + dv/dx - dw/dx$</p> <p>5. $d(uv)/dx = u dv/dx + v du/dx$</p> <p>6. $d(uvw)/dx = uv dw/dx + uw dv/dx + vw du/dx$</p> <p>7. $\frac{d(u/v)}{dx} = \frac{v du/dx - u dv/dx}{v^2}$</p> <p>8. $d(u^n)/dx = nu^{n-1} du/dx$</p> <p>9. $d[f(u)]/dx = \{d[f(u)]/du\} du/dx$</p> <p>10. $du/dx = 1/(dx/du)$</p> <p>11. $\frac{d(\log_a u)}{dx} = (\log_a e) \frac{1}{u} \frac{du}{dx}$</p> <p>12. $\frac{d(\ln u)}{dx} = \frac{1}{u} \frac{du}{dx}$</p> <p>13. $\frac{d(a^u)}{dx} = (\ln a) a^u \frac{du}{dx}$</p> <p>14. $d(e^u)/dx = e^u du/dx$</p> <p>15. $d(u^v)/dx = vu^{v-1} du/dx + (\ln u) u^v dv/dx$</p> <p>16. $d(\sin u)/dx = \cos u du/dx$</p> <p>17. $d(\cos u)/dx = -\sin u du/dx$</p> <p>18. $d(\tan u)/dx = \sec^2 u du/dx$</p> <p>19. $d(\cot u)/dx = -\csc^2 u du/dx$</p> <p>20. $d(\sec u)/dx = \sec u \tan u du/dx$</p> <p>21. $d(\csc u)/dx = -\csc u \cot u du/dx$</p> <p>22. $\frac{d(\sin^{-1} u)}{dx} = \frac{1}{\sqrt{1-u^2}} \frac{du}{dx} \quad (-\pi/2 \leq \sin^{-1} u \leq \pi/2)$</p> <p>23. $\frac{d(\cos^{-1} u)}{dx} = -\frac{1}{\sqrt{1-u^2}} \frac{du}{dx} \quad (0 \leq \cos^{-1} u \leq \pi)$</p> <p>24. $\frac{d(\tan^{-1} u)}{dx} = \frac{1}{1+u^2} \frac{du}{dx} \quad (-\pi/2 < \tan^{-1} u < \pi/2)$</p> <p>25. $\frac{d(\cot^{-1} u)}{dx} = -\frac{1}{1+u^2} \frac{du}{dx} \quad (0 < \cot^{-1} u < \pi)$</p> <p>26. $\frac{d(\sec^{-1} u)}{dx} = \frac{1}{u\sqrt{u^2-1}} \frac{du}{dx} \quad (0 \leq \sec^{-1} u < \pi/2) \quad (-\pi \leq \sec^{-1} u < -\pi/2)$</p> <p>27. $\frac{d(\csc^{-1} u)}{dx} = -\frac{1}{u\sqrt{u^2-1}} \frac{du}{dx} \quad (0 < \csc^{-1} u \leq \pi/2) \quad (-\pi < \csc^{-1} u \leq -\pi/2)$</p> | <p>1. $\int df(x) = f(x)$</p> <p>2. $\int dx = x$</p> <p>3. $\int a f(x) dx = a \int f(x) dx$</p> <p>4. $\int [u(x) \pm v(x)] dx = \int u(x) dx \pm \int v(x) dx$</p> <p>5. $\int x^m dx = \frac{x^{m+1}}{m+1} \quad (m \neq -1)$</p> <p>6. $\int u(x) dv(x) = u(x)v(x) - \int v(x) du(x)$</p> <p>7. $\int \frac{dx}{ax+b} = \frac{1}{a} \ln ax+b$</p> <p>8. $\int \frac{dx}{\sqrt{x}} = 2\sqrt{x}$</p> <p>9. $\int a^x dx = \frac{a^x}{\ln a}$</p> <p>10. $\int \sin x dx = -\cos x$</p> <p>11. $\int \cos x dx = \sin x$</p> <p>12. $\int \sin^2 x dx = \frac{x}{2} - \frac{\sin 2x}{4}$</p> <p>13. $\int \cos^2 x dx = \frac{x}{2} + \frac{\sin 2x}{4}$</p> <p>14. $\int x \sin x dx = \sin x - x \cos x$</p> <p>15. $\int x \cos x dx = \cos x + x \sin x$</p> <p>16. $\int \sin x \cos x dx = (\sin^2 x)/2$</p> <p>17. $\int \sin ax \cos bx dx = -\frac{\cos(a-b)x}{2(a-b)} - \frac{\cos(a+b)x}{2(a+b)} \quad (a^2 \neq b^2)$</p> <p>18. $\int \tan x dx = -\ln \cos x = \ln \sec x$</p> <p>19. $\int \cot x dx = -\ln \csc x = \ln \sin x$</p> <p>20. $\int \tan^2 x dx = \tan x - x$</p> <p>21. $\int \cot^2 x dx = -\cot x - x$</p> <p>22. $\int e^{ax} dx = (1/a) e^{ax}$</p> <p>23. $\int x e^{ax} dx = (e^{ax}/a^2)(ax - 1)$</p> <p>24. $\int \ln x dx = x [\ln(x) - 1] \quad (x > 0)$</p> <p>25. $\int \frac{dx}{a^2 + x^2} = \frac{1}{a} \tan^{-1} \frac{x}{a} \quad (a \neq 0)$</p> <p>26. $\int \frac{dx}{ax^2 + c} = \frac{1}{\sqrt{ac}} \tan^{-1} \left(x \sqrt{\frac{a}{c}} \right), \quad (a > 0, c > 0)$</p> <p>27a. $\int \frac{dx}{ax^2 + bx + c} = \frac{2}{\sqrt{4ac - b^2}} \tan^{-1} \frac{2ax + b}{\sqrt{4ac - b^2}} \quad (4ac - b^2 > 0)$</p> <p>27b. $\int \frac{dx}{ax^2 + bx + c} = \frac{1}{\sqrt{b^2 - 4ac}} \ln \left \frac{2ax + b - \sqrt{b^2 - 4ac}}{2ax + b + \sqrt{b^2 - 4ac}} \right \quad (b^2 - 4ac > 0)$</p> <p>27c. $\int \frac{dx}{ax^2 + bx + c} = -\frac{2}{2ax + b}, \quad (b^2 - 4ac = 0)$</p> |
|---|---|

MENSURATION OF AREAS AND VOLUMES

Nomenclature

A = total surface area

P = perimeter

V = volume

Parabola

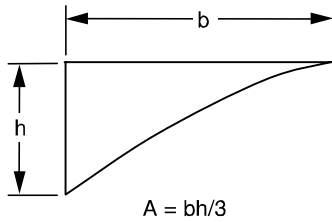
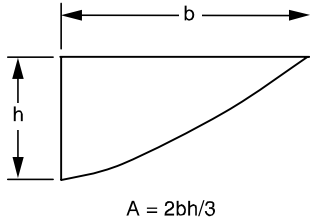

Ellipse

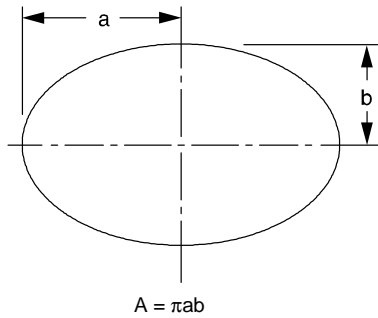

$$P_{approx} = 2\pi\sqrt{(a^2 + b^2)/2}$$

$$P = \pi(a + b) \left[1 + \left(\frac{1}{2}\right)^2 \lambda^2 + \left(\frac{1}{2} \times \frac{1}{4}\right)^2 \lambda^4 + \left(\frac{1}{2} \times \frac{1}{4} \times \frac{3}{6}\right)^2 \lambda^6 + \left(\frac{1}{2} \times \frac{1}{4} \times \frac{3}{6} \times \frac{5}{8}\right)^2 \lambda^8 + \left(\frac{1}{2} \times \frac{1}{4} \times \frac{3}{6} \times \frac{5}{8} \times \frac{7}{10}\right)^2 \lambda^{10} + \dots \right]$$

where

$$\lambda = (a - b)/(a + b)$$

Circular Segment

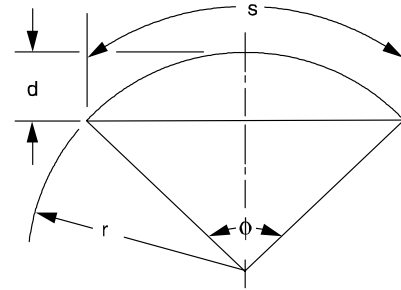

$$A = [r^2 (\phi - \sin \phi)]/2$$

$$\phi = s/r = 2 \{ \arccos [(r - d)/r] \}$$

Circular Sector

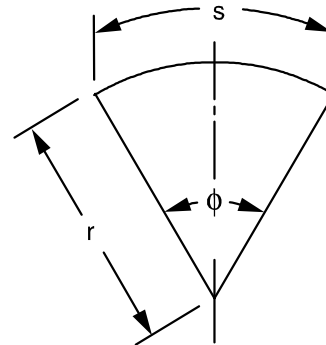

$$A = \phi r^2 / 2 = sr/2$$

$$\phi = s/r$$

Sphere

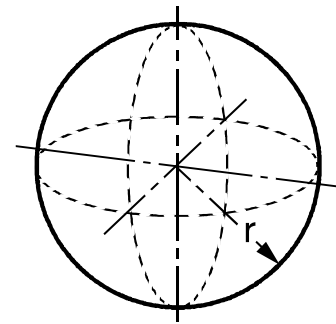

$$V = 4\pi r^3 / 3 = \pi d^3 / 6$$

$$A = 4\pi r^2 = \pi d^2$$

◆ Gieck, K. & Gieck R., *Engineering Formulas*, 6th Ed., Copyright © 1967 by Gieck Publishing. Diagrams reprinted by permission of Kurt Gieck.

MENSURATION OF AREAS AND VOLUMES

Parallelogram

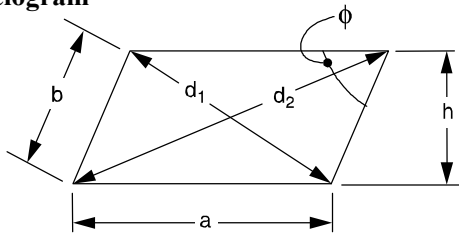

$$P = 2(a + b)$$

$$d_1 = \sqrt{a^2 + b^2 - 2ab(\cos\phi)}$$

$$d_2 = \sqrt{a^2 + b^2 + 2ab(\cos\phi)}$$

$$d_1^2 + d_2^2 = 2(a^2 + b^2)$$

$$A = ah = ab(\sin\phi)$$

If $a = b$, the parallelogram is a rhombus.

Regular Polygon (n equal sides)

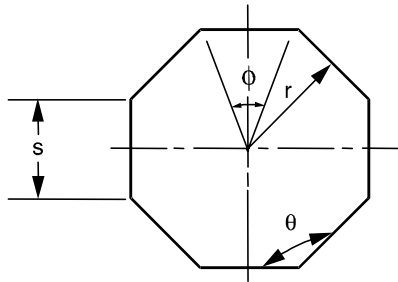

$$\phi = 2\pi/n$$

$$\theta = \left[\frac{\pi(n-2)}{n} \right] = \pi \left(1 - \frac{2}{n} \right)$$

$$P = ns$$

$$s = 2r [\tan(\phi/2)]$$

$$A = (nsr)/2$$

Prismoid

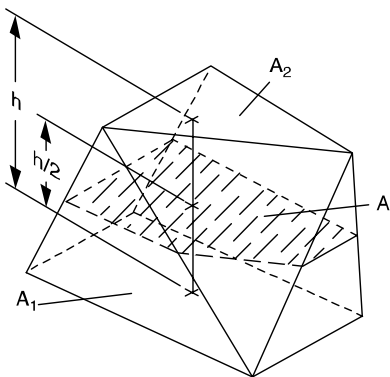

$$V = (h/6)(A_1 + A_2 + 4A)$$

Right Circular Cone

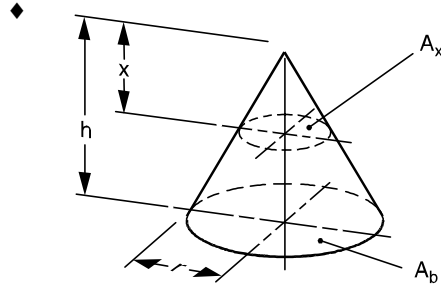

$$V = (\pi r^2 h)/3$$

A = side area + base area
 $= \pi r (r + \sqrt{r^2 + h^2})$
 $A_x : A_b = x^2 : h^2$

Right Circular Cylinder

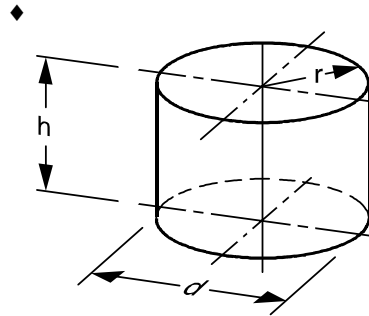

$$V = \pi r^2 h = \frac{\pi d^2 h}{4}$$

A = side area + end areas = $2\pi r(h + r)$

Paraboloid of Revolution

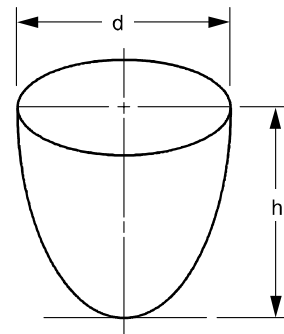

$$V = \frac{\pi d^2 h}{8}$$

♦ Gieck, K. & R. Gieck, *Engineering Formulas*, 6th Ed., Copyright 8 1967 by Gieck Publishing. Diagrams reprinted by permission of Kurt Gieck.

CENTROIDS AND MOMENTS OF INERTIA

The location of the centroid of an area, bounded by the axes and the function $y = f(x)$, can be found by integration.

$$x_c = \frac{\int x dA}{A}$$

$$y_c = \frac{\int y dA}{A}$$

$$A = \int f(x) dx$$

$$dA = f(x) dx = g(y) dy$$

The first moment of area with respect to the y -axis and the x -axis, respectively, are:

$$M_y = \int x dA = x_c A$$

$$M_x = \int y dA = y_c A$$

when either \bar{x} or \bar{y} is of finite dimensions then $\int x dA$ or $\int y dA$ refer to the centroid x or y of dA in these integrals. The moment of inertia (second moment of area) with respect to the y -axis and the x -axis, respectively, are:

$$I_y = \int x^2 dA$$

$$I_x = \int y^2 dA$$

The moment of inertia taken with respect to an axis passing through the area's centroid is the centroidal moment of inertia. The parallel axis theorem for the moment of inertia with respect to another axis parallel with and located d units from the centroidal axis is expressed by

$$I_{\text{parallel axis}} = I_c + Ad^2$$

In a plane, $J = \int r^2 dA = I_x + I_y$

Values for standard shapes are presented in a table in the DYNAMICS section.

DIFFERENTIAL EQUATIONS

A common class of ordinary linear differential equations is

$$b_n \frac{d^n y(x)}{dx^n} + \dots + b_1 \frac{dy(x)}{dx} + b_0 y(x) = f(x)$$

where $b_n, \dots, b_i, \dots, b_1, b_0$ are constants.

When the equation is a homogeneous differential equation, $f(x) = 0$, the solution is

$$y_h(x) = C_1 e^{r_1 x} + C_2 e^{r_2 x} + \dots + C_i e^{r_i x} + \dots + C_n e^{r_n x}$$

where r_n is the n th distinct root of the characteristic polynomial $P(x)$ with

$$P(r) = b_n r^n + b_{n-1} r^{n-1} + \dots + b_1 r + b_0$$

If the root $r_1 = r_2$, then $C_2 e^{r_2 x}$ is replaced with $C_2 x e^{r_1 x}$.

Higher orders of multiplicity imply higher powers of x . The complete solution for the differential equation is

$$y(x) = y_h(x) + y_p(x),$$

where $y_p(x)$ is any solution with $f(x)$ present. If $f(x)$ has $e^{r_n x}$ terms, then resonance is manifested. Furthermore, specific $f(x)$ forms result in specific $y_p(x)$ forms, some of which are:

$f(x)$	$y_p(x)$
A	B
$Ae^{\alpha x}$	$Be^{\alpha x}, \alpha \neq r_n$
$A_1 \sin \omega x + A_2 \cos \omega x$	$B_1 \sin \omega x + B_2 \cos \omega x$

If the independent variable is time t , then transient dynamic solutions are implied.

First-Order Linear Homogeneous Differential Equations With Constant Coefficients

$$y' + ay = 0, \text{ where } a \text{ is a real constant:}$$

$$\text{Solution, } y = Ce^{-at}$$

where C = a constant that satisfies the initial conditions.

First-Order Linear Nonhomogeneous Differential Equations

$$\tau \frac{dy}{dt} + y = Kx(t) \quad x(t) = \begin{cases} A & t < 0 \\ B & t > 0 \end{cases}$$

$$y(0) = KA$$

τ is the time constant

K is the gain

The solution is

$$y(t) = KA + (KB - KA) \left(1 - \exp\left(\frac{-t}{\tau}\right) \right) \text{ or}$$

$$\frac{t}{\tau} = \ln \left[\frac{KB - KA}{KB - y} \right]$$

Second-Order Linear Homogeneous Differential Equations with Constant Coefficients

An equation of the form

$$y'' + 2ay' + by = 0$$

can be solved by the method of undetermined coefficients where a solution of the form $y = Ce^{rx}$ is sought. Substitution of this solution gives

$$(r^2 + 2ar + b) Ce^{rx} = 0$$

and since Ce^{rx} cannot be zero, the characteristic equation must vanish or

$$r^2 + 2ar + b = 0$$

The roots of the characteristic equation are

$$r_{1,2} = -a \pm \sqrt{a^2 - b}$$

and can be real and distinct for $a^2 > b$, real and equal for $a^2 = b$, and complex for $a^2 < b$.

If $a^2 > b$, the solution is of the form (overdamped)

$$y = C_1 e^{r_1 x} + C_2 e^{r_2 x}$$

If $a^2 = b$, the solution is of the form (critically damped)

$$y = (C_1 + C_2 x) e^{r_1 x}$$

If $a^2 < b$, the solution is of the form (underdamped)

$$y = e^{\alpha x} (C_1 \cos \beta x + C_2 \sin \beta x), \text{ where}$$

$$\alpha = -a$$

$$\beta = \sqrt{b - a^2}$$

FOURIER SERIES

Every function $F(t)$ which has the period $\tau = 2\pi/\omega$ and satisfies certain continuity conditions can be represented by a series plus a constant.

$$F(t) = a_0/2 + \sum_{n=1}^{\infty} [a_n \cos(n\omega t) + b_n \sin(n\omega t)]$$

The above equation holds if $F(t)$ has a continuous derivative $F'(t)$ for all t . Multiply both sides of the equation by $\cos m\omega t$ and integrate from 0 to τ .

$$\begin{aligned} \int_0^\tau F(t) \cos(m\omega t) dt &= \int_0^\tau (a_0/2) \cos(m\omega t) dt \\ \int_0^\tau F(t) \cos(m\omega t) dt &= \int_0^\tau (a_0/2) \cos(m\omega t) dt \\ &+ \sum_{n=1}^{\infty} [a_n \int_0^\tau \cos(m\omega t) \cos(n\omega t) dt \\ &+ b_n \int_0^\tau \sin(m\omega t) \cos(n\omega t) dt] \end{aligned}$$

Term-by-term integration of the series can be justified if $F(t)$ is continuous. The coefficients are

$$a_n = (2/\tau) \int_0^\tau F(t) \cos(n\omega t) dt \quad \text{and} \\ b_n = (2/\tau) \int_0^\tau F(t) \sin(n\omega t) dt, \quad \text{where}$$

$\tau = 2\pi/\omega$. The constants a_n, b_n are the Fourier coefficients of $F(t)$ for the interval 0 to τ , and the corresponding series is called the Fourier series of $F(t)$ over the same interval. The integrals have the same value over any interval of length τ .

If a Fourier series representing a periodic function is truncated after term $n = N$, the mean square value F_N^2 of the truncated series is given by the Parseval relation. This relation says that the mean square value is the sum of the mean square values of the Fourier components, or

$$F_N^2 = (a_0/2)^2 + (1/2) \sum_{n=1}^N (a_n^2 + b_n^2)$$

and the RMS value is then defined to be the square root of this quantity or F_N .

FOURIER TRANSFORM

The Fourier transform pair, one form of which is

$$F(\omega) = \int_{-\infty}^{\infty} f(t) e^{-j\omega t} dt \\ f(t) = [1/(2\pi)] \int_{-\infty}^{\infty} F(\omega) e^{j\omega t} d\omega$$

can be used to characterize a broad class of signal models in terms of their frequency or spectral content. Some useful transform pairs are:

$f(t)$	$F(\omega)$
$\delta(t)$	1
$u(t)$	$\pi \delta(\omega) + 1/j\omega$
$u\left(t + \frac{\tau}{2}\right) - u\left(t - \frac{\tau}{2}\right) = r_{rect} \frac{t}{\tau}$	$\tau \frac{\sin(\omega\tau/2)}{\omega\tau/2}$
$e^{j\omega_0 t}$	$2\pi\delta(\omega - \omega_0)$

Some mathematical liberties are required to obtain the second and fourth form. Other Fourier transforms are derivable from the Laplace transform by replacing s with $j\omega$ provided

$$f(t) = 0, t < 0 \\ \int_0^\infty |f(t)| dt < \infty$$

LAPLACE TRANSFORMS

The unilateral Laplace transform pair

$$F(s) = \int_0^\infty f(t) e^{-st} dt \\ f(t) = \frac{1}{2\pi i} \int_{\sigma-i\infty}^{\sigma+i\infty} F(s) e^{st} ds$$

represents a powerful tool for the transient and frequency response of linear time invariant systems. Some useful Laplace transform pairs are [Note: The last two transforms represent the Final Value Theorem (F.V.T.) and Initial Value Theorem (I.V.T.) respectively. It is assumed that the limits exist.]:

$f(t)$	$F(s)$
$\delta(t)$, Impulse at $t = 0$	1
$u(t)$, Step at $t = 0$	1/s
$t[u(t)]$, Ramp at $t = 0$	1/s ²
$e^{-\alpha t}$	1/(s + α)
$te^{-\alpha t}$	1/(s + α) ²
$e^{-\alpha t} \sin \beta t$	$\beta / [(s + \alpha)^2 + \beta^2]$
$e^{-\alpha t} \cos \beta t$	$(s + \alpha) / [(s + \alpha)^2 + \beta^2]$
$\frac{d^n f(t)}{dt^n}$	$s^n F(s) - \sum_{m=0}^{n-1} s^{n-m-1} \frac{d^m f(0)}{dt^m}$
$\int_0^t f(\tau) d\tau$	(1/s)F(s)
$\int_0^t x(t - \tau)h(\tau) d\tau$	H(s)X(s)
$f(t - \tau)$	$e^{-\tau s} F(s)$
limit $f(t)$ $t \rightarrow \infty$	limit $sF(s)$ $s \rightarrow 0$
limit $f(t)$ $t \rightarrow 0$	limit $sF(s)$ $s \rightarrow \infty$

DIFFERENCE EQUATIONS

Difference equations are used to model discrete systems. Systems which can be described by difference equations include computer program variables iteratively evaluated in a loop, sequential circuits, cash flows, recursive processes, systems with time-delay components, etc. Any system whose input $v(t)$ and output $y(t)$ are defined only at the equally spaced intervals $t = kT$ can be described by a difference equation.

First-Order Linear Difference Equation

The difference equation

$$P_k = P_{k-1}(1 + i) - A$$

represents the balance P of a loan after the k th payment A . If P_k is defined as $y(k)$, the model becomes

$$y(k) - (1 + i)y(k - 1) = -A$$

Second-Order Linear Difference Equation

The Fibonacci number sequence can be generated by

$$y(k) = y(k - 1) + y(k - 2)$$

where $y(-1) = 1$ and $y(-2) = 1$. An alternate form for this model is $f(k + 2) = f(k + 1) + f(k)$

$$\text{with } f(0) = 1 \text{ and } f(1) = 1.$$

z-Transforms

The transform definition is

$$F(z) = \sum_{k=0}^{\infty} f(k)z^{-k}$$

The inverse transform is given by the contour integral

$$f(k) = \frac{1}{2\pi i} \oint_{\Gamma} F(z)z^{k-1} dz$$

and it represents a powerful tool for solving linear shift invariant difference equations. A limited unilateral list of z -transform pairs follows [Note: The last two transform pairs represent the Initial Value Theorem (I.V.T.) and the Final Value Theorem (F.V.T.) respectively.]:

$f(k)$	$F(z)$
$\delta(k)$, Impulse at $k = 0$	1
$u(k)$, Step at $k = 0$	$1/(1 - z^{-1})$
β^k	$1/(1 - \beta z^{-1})$
$y(k - 1)$	$z^{-1}Y(z) + y(-1)$
$y(k - 2)$	$z^{-2}Y(z) + y(-2) + y(-1)z^{-1}$
$y(k + 1)$	$zY(z) - zy(0)$
$y(k + 2)$	$z^2Y(z) - z^2y(0) - zy(1)$
$\sum_{m=0}^{\infty} X(k - m)h(m)$	$H(z)X(z)$
$\lim_{k \rightarrow 0} f(k)$	$\lim_{z \rightarrow \infty} F(z)$
$\lim_{k \rightarrow \infty} f(k)$	$\lim_{z \rightarrow 1} (1 - z^{-1})F(z)$

NUMERICAL METHODS

Newton's Method of Root Extraction

Given a polynomial $P(x)$ with n simple roots, a_1, a_2, \dots, a_n where

$$P(x) = \prod_{m=1}^n (x - a_m) = x^n + \alpha_1 x^{n-1} + \alpha_2 x^{n-2} + \dots + \alpha_n$$

and $P(a_i) = 0$. A root a_i can be computed by the iterative algorithm

$$a_i^{j+1} = a_i^j - \frac{P(x)}{\partial P(x)/\partial x} \Big|_{x=a_i^j}$$

with $|P(a_i^{j+1})| \leq |P(a_i^j)|$ Convergence is quadratic.

Newton's method may also be used for any function with a continuous first derivative.

Newton's Method of Minimization

Given a scalar value function

$$h(\mathbf{x}) = h(x_1, x_2, \dots, x_n)$$

find a vector $\mathbf{x}^* \in R_n$ such that

$$h(\mathbf{x}^*) \leq h(\mathbf{x}) \text{ for all } \mathbf{x}$$

Newton's algorithm is

$$\mathbf{x}_{K+1} = \mathbf{x}_K - \left(\frac{\partial^2 h}{\partial x^2} \Big|_{\mathbf{x} = \mathbf{x}_K} \right)^{-1} \frac{\partial h}{\partial x} \Big|_{\mathbf{x} = \mathbf{x}_K}, \text{ where}$$

$$\frac{\partial h}{\partial x} = \begin{bmatrix} \frac{\partial h}{\partial x_1} \\ \frac{\partial h}{\partial x_2} \\ \dots \\ \dots \\ \frac{\partial h}{\partial x_n} \end{bmatrix}$$

and

$$\frac{\partial^2 h}{\partial x^2} = \begin{bmatrix} \frac{\partial^2 h}{\partial x_1^2} & \frac{\partial^2 h}{\partial x_1 \partial x_2} & \dots & \dots & \frac{\partial^2 h}{\partial x_1 \partial x_n} \\ \frac{\partial^2 h}{\partial x_1 \partial x_2} & \frac{\partial^2 h}{\partial x_2^2} & \dots & \dots & \frac{\partial^2 h}{\partial x_2 \partial x_n} \\ \dots & \dots & \dots & \dots & \dots \\ \dots & \dots & \dots & \dots & \dots \\ \frac{\partial^2 h}{\partial x_1 \partial x_n} & \frac{\partial^2 h}{\partial x_2 \partial x_n} & \dots & \dots & \frac{\partial^2 h}{\partial x_n^2} \end{bmatrix}$$

Numerical Integration

Three of the more common numerical integration algorithms used to evaluate the integral

$$\int_a^b f(x)dx$$

are:

Euler's or Forward Rectangular Rule

$$\int_a^b f(x)dx \approx \Delta x \sum_{k=0}^{n-1} f(a + k\Delta x)$$

Trapezoidal Rule

for $n = 1$

$$\int_a^b f(x)dx \approx \Delta x \left[\frac{f(a) + f(b)}{2} \right]$$

for $n > 1$

$$\int_a^b f(x)dx \approx \frac{\Delta x}{2} \left[f(a) + 2 \sum_{k=1}^{n-1} f(a + k\Delta x) + f(b) \right]$$

Simpson's Rule/Parabolic Rule (n must be an even integer)

for $n = 2$

$$\int_a^b f(x)dx \approx \left(\frac{b-a}{6} \right) \left[f(a) + 4f\left(\frac{a+b}{2}\right) + f(b) \right]$$

for $n \geq 4$

$$\int_a^b f(x)dx \approx \frac{\Delta x}{3} \left[f(a) + 2 \sum_{k=2,4,6,\dots}^{n-2} f(a + k\Delta x) + 4 \sum_{k=1,3,5,\dots}^{n-1} f(a + k\Delta x) + f(b) \right]$$

with $\Delta x = (b - a)/n$

Numerical Solution of Ordinary Differential Equations

Euler's Approximation

Given a differential equation

$$dx/dt = f(x, t) \text{ with } x(0) = x_0$$

At some general time $k\Delta t$

$$x[(k + 1)\Delta t] \cong x(k\Delta t) + \Delta t f[x(k\Delta t), k\Delta t]$$

which can be used with starting condition x_0 to solve recursively for $x(\Delta t), x(2\Delta t), \dots, x(n\Delta t)$.

The method can be extended to n th order differential equations by recasting them as n first-order equations.

In particular, when $dx/dt = f(x)$

$$x[(k + 1)\Delta t] \cong x(k\Delta t) + \Delta t f[x(k\Delta t)]$$

which can be expressed as the recursive equation

$$x_{k+1} = x_k + \Delta t (dx_k / dt)$$

STATICS

FORCE

A *force* is a *vector* quantity. It is defined when its (1) magnitude, (2) point of application, and (3) direction are known.

RESULTANT (TWO DIMENSIONS)

The *resultant*, F , of n forces with components $F_{x,i}$ and $F_{y,i}$ has the magnitude of

$$F = \left[\left(\sum_{i=1}^n F_{x,i} \right)^2 + \left(\sum_{i=1}^n F_{y,i} \right)^2 \right]^{1/2}$$

The resultant direction with respect to the x -axis using four-quadrant angle functions is

$$\theta = \arctan \left(\frac{\sum_{i=1}^n F_{y,i}}{\sum_{i=1}^n F_{x,i}} \right)$$

The vector form of the force is

$$\mathbf{F} = F_x \mathbf{i} + F_y \mathbf{j}$$

RESOLUTION OF A FORCE

$$F_x = F \cos \theta_x; F_y = F \cos \theta_y; F_z = F \cos \theta_z$$

$$\cos \theta_x = F_x/F; \cos \theta_y = F_y/F; \cos \theta_z = F_z/F$$

Separating a force into components (geometry of force is known $R = \sqrt{x^2 + y^2 + z^2}$)

$$F_x = (x/R)F; \quad F_y = (y/R)F; \quad F_z = (z/R)F$$

MOMENTS (COUPLES)

A system of two forces that are equal in magnitude, opposite in direction, and parallel to each other is called a *couple*.

A *moment* \mathbf{M} is defined as the cross product of the *radius vector* distance \mathbf{r} and the *force* \mathbf{F} from a point to the line of action of the force.

$$\begin{aligned} \mathbf{M} &= \mathbf{r} \times \mathbf{F}; & M_x &= yF_z - zF_y, \\ & & M_y &= zF_x - xF_z, \text{ and} \\ & & M_z &= xF_y - yF_x. \end{aligned}$$

SYSTEMS OF FORCES

$$\mathbf{F} = \sum \mathbf{F}_n$$

$$\mathbf{M} = \sum (\mathbf{r}_n \times \mathbf{F}_n)$$

Equilibrium Requirements

$$\sum \mathbf{F}_n = 0$$

$$\sum \mathbf{M}_n = 0$$

CENTROIDS OF MASSES, AREAS, LENGTHS, AND VOLUMES

Formulas for centroids, moments of inertia, and first moment of areas are presented in the **MATHEMATICS** section for continuous functions. The following discrete formulas are for defined regular masses, areas, lengths, and volumes:

$$\mathbf{r}_c = \sum m_n \mathbf{r}_n / \sum m_n, \text{ where}$$

m_n = the *mass of each particle* making up the system,

\mathbf{r}_n = the *radius vector* to each particle from a selected reference point, and

\mathbf{r}_c = the *radius vector* to the *center of the total mass* from the selected reference point.

The *moment of area* (M_a) is defined as

$$M_{ay} = \sum x_n a_n$$

$$M_{ax} = \sum y_n a_n$$

$$M_{az} = \sum z_n a_n$$

The *centroid of area* is defined as

$$x_{ac} = M_{ay}/A \quad \left. \begin{array}{l} \text{with respect to center} \\ \text{of the coordinate system} \end{array} \right\}$$

$$y_{ac} = M_{ax}/A$$

$$z_{ac} = M_{az}/A$$

where $A = \sum a_n$

The *centroid of a line* is defined as

$$x_{lc} = (\sum x_n l_n)/L, \text{ where } L = \sum l_n$$

$$y_{lc} = (\sum y_n l_n)/L$$

$$z_{lc} = (\sum z_n l_n)/L$$

The *centroid of volume* is defined as

$$x_{vc} = (\sum x_n v_n)/V, \text{ where } V = \sum v_n$$

$$y_{vc} = (\sum y_n v_n)/V$$

$$z_{vc} = (\sum z_n v_n)/V$$

MOMENT OF INERTIA

The *moment of inertia*, or the second moment of area, is defined as

$$I_y = \int x^2 dA$$

$$I_x = \int y^2 dA$$

The *polar moment of inertia* J of an area about a point is equal to the sum of the moments of inertia of the area about any two perpendicular axes in the area and passing through the same point.

$$I_z = J = I_y + I_x = \int (x^2 + y^2) dA$$

$$= r_p^2 A, \text{ where}$$

r_p = the *radius of gyration* (see page 23).

Moment of Inertia Transfer Theorem

The moment of inertia of an area about any axis is defined as the moment of inertia of the area about a parallel centroidal axis plus a term equal to the area multiplied by the square of the perpendicular distance d from the centroidal axis to the axis in question.

$$I'_x = I_{x_c} + d_x^2 A$$

$$I'_y = I_{y_c} + d_y^2 A, \text{ where}$$

d_x, d_y = distance between the two axes in question,

I_{x_c}, I_{y_c} = the moment of inertia about the centroidal axis, and

I'_x, I'_y = the moment of inertia about the new axis.

Radius of Gyration

The *radius of gyration* r_p, r_x, r_y is the distance from a reference axis at which all of the area can be considered to be concentrated to produce the moment of inertia.

$$r_x = \sqrt{I_x/A}; \quad r_y = \sqrt{I_y/A}; \quad r_p = \sqrt{J/A}$$

Product of Inertia

The *product of inertia* (I_{xy} , etc.) is defined as:

$I_{xy} = \int xy dA$, with respect to the xy -coordinate system,

$I_{xz} = \int xz dA$, with respect to the xz -coordinate system, and

$I_{yz} = \int yz dA$, with respect to the yz -coordinate system.

The *transfer theorem* also applies:

$$I'_{xy} = I_{x_c y_c} + d_x d_y A \text{ for the } xy\text{-coordinate system, etc.}$$

where

d_x = x -axis distance between the two axes in question, and

d_y = y -axis distance between the two axes in question.

FRICITION

The largest frictional force is called the *limiting friction*. Any further increase in applied forces will cause motion.

$$F = \mu N, \text{ where}$$

F = friction force,

μ = *coefficient of static friction*, and

N = normal force between surfaces in contact.

SCREW THREAD

For a *screw-jack, square thread*,

$$M = Pr \tan(\alpha \pm \phi), \text{ where}$$

+ is for screw tightening,

- is for screw loosening,

M = external moment applied to axis of screw,

P = load on jack applied along and on the line of the axis,

r = the mean thread radius,

α = the *pitch angle* of the thread, and

μ = $\tan \phi$ = the appropriate coefficient of friction.

BRAKE-BAND OR BELT FRICTION

$$F_1 = F_2 e^{\mu \theta}, \text{ where}$$

F_1 = force being applied in the direction of impending motion,

F_2 = force applied to resist impending motion,

μ = coefficient of static friction, and

θ = the total *angle of contact* between the surfaces expressed in radians.

STATICALLY DETERMINATE TRUSS

Plane Truss

A plane truss is a rigid framework satisfying the following conditions:

1. The members of the truss lie in the same plane.
2. The members are connected at their ends by frictionless pins.
3. All of the external loads lie in the plane of the truss and are applied at the joints only.
4. The truss reactions and member forces can be determined using the equations of equilibrium.
 $\Sigma F = 0; \Sigma M = 0$
5. A truss is statically indeterminate if the reactions and member forces cannot be solved with the equations of equilibrium.

Plane Truss: Method of Joints

The method consists of solving for the forces in the members by writing the two equilibrium equations for each joint of the truss.

$$\Sigma F_V = 0 \text{ and } \Sigma F_H = 0, \text{ where}$$

F_H = horizontal forces and member components and

F_V = vertical forces and member components.

Plane Truss: Method of Sections

The method consists of drawing a free-body diagram of a portion of the truss in such a way that the unknown truss member force is exposed as an external force.

CONCURRENT FORCES

A system of forces wherein their lines of action all meet at one point.

Two Dimensions

$$\Sigma F_x = 0; \Sigma F_y = 0$$

Three Dimensions

$$\Sigma F_x = 0; \Sigma F_y = 0; \Sigma F_z = 0$$

DYNAMICS

KINEMATICS

Vector representation of motion in space: Let $\mathbf{r}(t)$ be the position vector of a particle. Then the velocity is

$$\mathbf{v} = d\mathbf{r}/dt, \text{ where}$$

\mathbf{v} = the instantaneous velocity of the particle,
(length/time), and

t = time.

The acceleration is

$$\mathbf{a} = d\mathbf{v}/dt = d^2\mathbf{r}/dt^2, \text{ where}$$

\mathbf{a} = the instantaneous acceleration of the particle,
(length/time/time).

Rectangular Coordinates

$$\mathbf{r} = x\mathbf{i} + y\mathbf{j} + z\mathbf{k}$$

$$\mathbf{v} = d\mathbf{r}/dt = \dot{x}\mathbf{i} + \dot{y}\mathbf{j} + \dot{z}\mathbf{k}$$

$$\mathbf{a} = d^2\mathbf{r}/dt^2 = \ddot{x}\mathbf{i} + \ddot{y}\mathbf{j} + \ddot{z}\mathbf{k}, \text{ where}$$

$$\dot{x} = dx/dt = v_x, \text{ etc.}$$

$$\ddot{x} = d^2x/dt^2 = a_x, \text{ etc.}$$

Transverse and Radial Components for Planar Problems

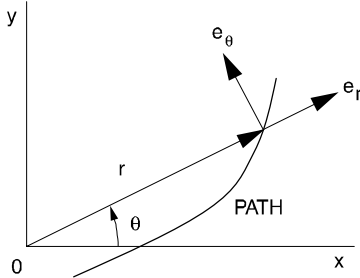

Unit vectors \mathbf{e}_r and \mathbf{e}_θ are, respectively, colinear with and normal to the position vector.

$$\mathbf{r} = r\mathbf{e}_r$$

$$\mathbf{v} = \dot{r}\mathbf{e}_r + r\dot{\theta}\mathbf{e}_\theta$$

$$\mathbf{a} = (\ddot{r} - r\dot{\theta}^2)\mathbf{e}_r + (r\ddot{\theta} + 2\dot{r}\dot{\theta})\mathbf{e}_\theta, \text{ where}$$

r = the radius,

θ = the angle between the x-axis and r ,

$\dot{r} = dr/dt$, etc., and

$$\ddot{r} = d^2r/dt^2, \text{ etc.}$$

Tangential and Normal Components

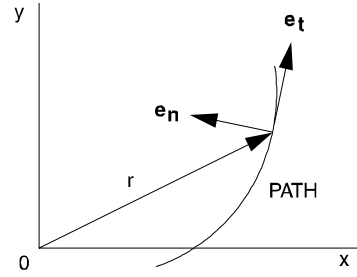

Unit vectors \mathbf{e}_n and \mathbf{e}_t are, respectively, normal and tangent to the path.

$$\mathbf{v} = v_t\mathbf{e}_t$$

$$\mathbf{a} = (dv_t/dt)\mathbf{e}_t + (v_t^2/\rho)\mathbf{e}_n, \text{ where}$$

ρ = instantaneous radius of curvature, and

v_t = tangential velocity.

Plane Circular Motion

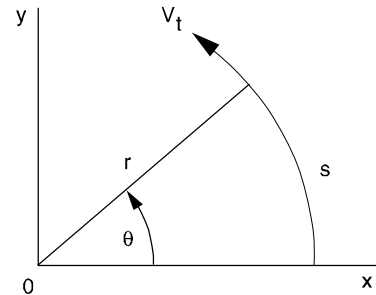

Rotation about the origin with constant radius: The unit vectors are $\mathbf{e}_t = \mathbf{e}_\theta$ and $\mathbf{e}_r = -\mathbf{e}_n$.

Angular velocity

$$\omega = \dot{\theta} = v_t/r$$

Angular acceleration

$$\alpha = \dot{\omega} = \ddot{\theta} = a_t/r$$

$$s = r\theta$$

$$v_t = r\omega$$

Tangential acceleration

$$a_t = r\alpha = dv_t/dt$$

Normal acceleration

$$a_n = v_t^2/r = r\omega^2$$

Straight Line Motion

Constant acceleration equations:

$$s = s_0 + v_0 t + (a_0 t^2) / 2$$

$$v = v_0 + a_0 t$$

$$v^2 = v_0^2 + 2a_0(s - s_0), \text{ where}$$

s = distance along the line traveled,

s_0 = an initial distance from origin (constant),

v_0 = an initial velocity (constant),

a_0 = a constant acceleration,

t = time, and

v = velocity at time t .

For a free-falling body, $a_0 = g$ (downward)

Using variable velocity, $v(t)$

$$s = s_0 + \int_0^t v(t) dt$$

Using variable acceleration, $a(t)$

$$v = v_0 + \int_0^t a(t) dt$$

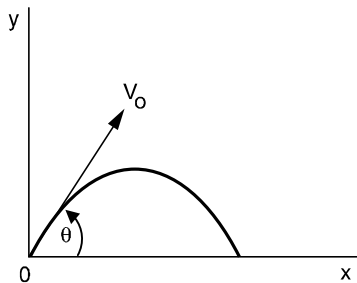
PROJECTILE MOTION

$$a_x = 0; \quad a_y = -g$$

$$v_x = v_{x0} = v_0 \cos \theta$$

$$v_y = v_{y0} - gt = v_0 \sin \theta - gt$$

$$x = v_{x0} t = v_0 t \cos \theta$$

$$y = v_{y0} t - gt^2 / 2 = v_0 t \sin \theta - gt^2 / 2$$

CONCEPT OF WEIGHT

$$W = mg, \text{ where}$$

W = weight, N (lbf),

m = mass, kg (lbf-sec²/ft), and

g = local acceleration of gravity, m/sec² (ft/sec²).

KINETICS

Newton's second law for a particle

$$\Sigma \mathbf{F} = d(m\mathbf{v})/dt, \text{ where}$$

$\Sigma \mathbf{F}$ = the sum of the applied forces acting on the particle, N (lbf).

For a constant mass,

$$\Sigma \mathbf{F} = m d\mathbf{v}/dt = m\mathbf{a}$$

One-Dimensional Motion of Particle

When referring to motion in the x -direction,

$$a_x = F_x / m, \text{ where}$$

F_x = the resultant of the applied forces in the x -direction.
 F_x can depend on t , x and v_x in general.

If F_x depends only on t , then

$$v_x(t) = v_{x0} + \int_0^t [F_x(t')/m] dt'$$

$$x(t) = x_0 + v_{x0} t + \int_0^t v_x(t') dt'$$

If the force is constant (independent of time, displacement, or velocity),

$$a_x = F_x / m$$

$$v_x = v_{x0} + (F_x / m) t = v_{x0} + a_x t$$

$$x = x_0 + v_{x0} t + F_x t^2 / (2m)$$

$$= x_0 + v_{x0} t + a_x t^2 / 2$$

Tangential and Normal Kinetics for Planar Problems

Working with the tangential and normal directions,

$$\Sigma F_t = ma_t = m dv_t / dt \text{ and}$$

$$\Sigma F_n = ma_n = m (v_t^2 / \rho)$$

Impulse and Momentum

Assuming the mass is constant, the equation of motion is

$$m dv_x / dt = F_x$$

$$m dv_x = F_x dt$$

$$m [v_x(t) - v_x(0)] = \int_0^t F_x(t') dt'$$

The left side of the equation represents the change in linear momentum of a body or particle. The right side is termed the impulse of the force $F_x(t')$ between $t' = 0$ and $t' = t$.

Work and Energy

Work W is defined as

$$W = \int \mathbf{F} \cdot d\mathbf{r}$$

(For particle flow, see **FLUID MECHANICS** section.)

Kinetic Energy

The kinetic energy of a particle is the work done by an external agent in accelerating the particle from rest to a velocity v .

$$T = mv^2 / 2$$

In changing the velocity from v_1 to v_2 , the change in kinetic energy is

$$T_2 - T_1 = mv_2^2 / 2 - mv_1^2 / 2$$

Potential Energy

The work done by an external agent in the presence of a conservative field is termed the change in potential energy.

Potential Energy in Gravity Field

$$U = mgh, \text{ where}$$

h = the elevation above a specified datum.

Elastic Potential Energy

For a linear elastic spring with modulus, stiffness, or spring constant k , the force is

$$F_s = kx, \text{ where}$$

x = the change in length of the spring from the undeformed length of the spring.

The potential energy stored in the spring when compressed or extended by an amount x is

$$U = kx^2/2$$

The change of potential energy in deforming a spring from position x_1 to position x_2 is

$$U_2 - U_1 = kx_2^2/2 - kx_1^2/2$$

Principle of Work and Energy

If T_i and U_i are kinetic energy and potential energy at state i , then for conservative systems (no energy dissipation), the law of conservation of energy is

$$U_1 + T_1 = U_2 + T_2.$$

If nonconservative forces are present, then the work done by these forces must be accounted for.

$$U_1 + T_1 + W_{1 \rightarrow 2} = U_2 + T_2$$

(Care must be exercised during computations to correctly compute the algebraic sign of the work term).

Impact

Momentum is conserved while energy may or may not be conserved. For direct central impact with no external forces

$$m_1v_1 + m_2v_2 = m_1v'_1 + m_2v'_2, \text{ where}$$

m_1, m_2 = the masses of the two bodies,

v_1, v_2 = their velocities before impact, and

v'_1, v'_2 = their velocities after impact.

For impact with dissipation of energy, the relative velocity expression is

$$e = \frac{v'_{2n} - v'_{1n}}{v_{1n} - v_{2n}}, \text{ where}$$

e = the coefficient of restitution for the materials, and the subscript n denotes the components normal to the plane of impact.

Knowing e , the velocities after rebound are

$$v'_{1n} = \frac{m_2v_{2n}(1+e) + (m_1 - em_2)v_{1n}}{m_1 + m_2}$$

$$v'_2 = \frac{m_1v_{1n}(1+e) - (em_1 - m_2)v_{2n}}{m_1 + m_2}$$

where $0 \leq e \leq 1$,

$e = 1$, perfectly elastic, and

$e = 0$, perfectly plastic (no rebound).

FRICTION

The Laws of Friction are

1. The total friction force F that can be developed is independent of the magnitude of the area of contact.
2. The total friction force F that can be developed is proportional to the normal force N .
3. For low velocities of sliding, the total friction force that can be developed is practically independent of the velocity, although experiments show that the force F necessary to start sliding is greater than that necessary to maintain sliding.

The formula expressing the laws of friction is

$$F = \mu N, \text{ where}$$

μ = the coefficient of friction.

Static friction will be less than or equal to $\mu_s N$, where μ_s is the coefficient of static friction. At the point of impending motion,

$$F = \mu_s N$$

When motion is present

$$F = \mu_k N, \text{ where}$$

μ_k = the coefficient of kinetic friction. The value of μ_k is often taken to be 75% of μ_s .

Belt friction is discussed in the **STATICS** section.

MASS MOMENT OF INERTIA

$$I_z = \int (x^2 + y^2) dm$$

A table listing moment of inertia formulas is available at the end of this section for some standard shapes.

Parallel Axis Theorem

$$I_z = I_{zc} + md^2, \text{ where}$$

I_z = the mass moment of inertia about a specific axis (in this case, the z -axis),

I_{zc} = the mass moment of inertia about the body's mass center (in this case, parallel to the z -axis),

m = the mass of the body, and

d = the normal distance from the mass center to the specific axis desired (in this case, the z -axis).

Also,

$$I_z = mr_z^2, \text{ where}$$

m = the total mass of the body, and

r_z = the radius of gyration (in this case, about the z -axis).

PLANE MOTION OF A RIGID BODY

For a rigid body in plane motion in the x - y plane

$$\Sigma F_x = ma_{xc}$$

$$\Sigma F_y = ma_{yc}$$

$$\Sigma M_{zc} = I_{zc}\alpha, \text{ where}$$

c = the center of gravity, and

α = angular acceleration of the body.

Rotation About a Fixed Axis

$$\Sigma M_O = I_O\alpha, \text{ where}$$

O denotes the axis about which rotation occurs.

For rotation about a fixed axis caused by a constant applied moment M

$$\alpha = M/I$$

$$\omega = \omega_0 + (M/I)t$$

$$\theta = \theta_0 + \omega_0 t + (M/2I)t^2$$

The change in kinetic energy of rotation is the work done in accelerating the rigid body from ω_0 to ω .

$$I_O \omega^2/2 - I_O \omega_0^2/2 = \int_{\theta_0}^{\theta} M d\theta$$

Kinetic Energy

The kinetic energy of a body in plane motion is

$$T = m(v_{xc}^2 + v_{yc}^2)/2 + I_c \omega^2/2$$

Instantaneous Center of Rotation

The instantaneous center of rotation for a body in plane motion is defined as that position about which all portions of that body are rotating.

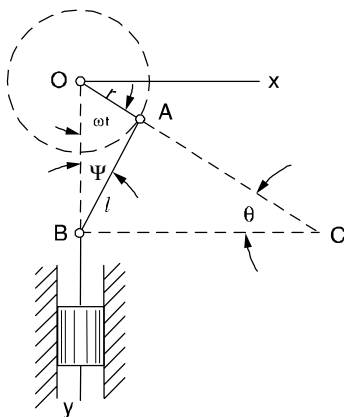

$$AC\dot{\theta} = r\omega, \text{ and}$$

$$v_b = BC\dot{\theta}, \text{ where}$$

C = the instantaneous center of rotation,

$\dot{\theta}$ = the rotational velocity about C , and

AC, BC = radii determined by the geometry of the situation.

CENTRIFUGAL FORCE

For a rigid body (of mass m) rotating about a fixed axis, the centrifugal force of the body at the point of rotation is

$$F_c = mr\omega^2 = mv^2/r, \text{ where}$$

r = the distance from the center of rotation to the center of the mass of the body.

BANKING OF CURVES (WITHOUT FRICTION)

$$\tan \theta = v^2/(gr), \text{ where}$$

θ = the angle between the roadway surface and the horizontal,

v = the velocity of the vehicle, and

r = the radius of the curve.

FREE VIBRATION

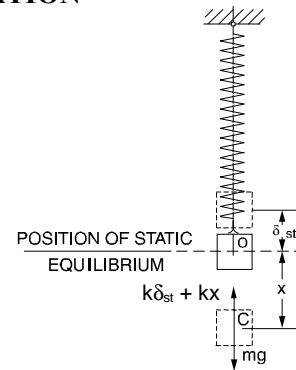

The equation of motion is

$$m\ddot{x} = mg - k(x + \delta_{st})$$

From static equilibrium

$$mg = k\delta_{st},$$

where

k = the spring constant, and

δ_{st} = the static deflection of the spring supporting the weight (mg).

The above equation of motion may now be rewritten as

$$m\ddot{x} + kx = 0, \text{ or}$$

$$\ddot{x} + (k/m)x = 0.$$

The solution to this differential equation is

$$x(t) = C_1 \cos \sqrt{(k/m)t} + C_2 \sin \sqrt{(k/m)t}, \text{ where}$$

$x(t)$ = the displacement in the x -direction, and

C_1, C_2 = constants of integration whose values depend on the initial conditions of the problem.

The quantity $\sqrt{k/m}$ is called the undamped natural

frequency ω_n or $\omega_n = \sqrt{k/m}$

• Timoshenko, S. and D.H. Young, *Engineering Mechanics*, Copyright © 1951 by McGraw-Hill Company, Inc. Diagrams reproduction permission pending.

From the static deflection relation

$$\omega_n = \sqrt{g/\delta_{st}}$$

The period of vibration is

$$\tau = 2\pi/\omega_n = 2\pi\sqrt{m/k} = 2\pi\sqrt{\delta_{st}/g}$$

If the initial conditions are $x(0) = x_0$ and $\dot{x}(0) = v_0$, then

$$x(t) = x_0 \cos \omega_n t + (v_0/\omega_n) \sin \omega_n t$$

If the initial conditions are $x(0) = x_0$ and $\dot{x}(0) = 0$, then

$$x(t) = x_0 \cos \omega_n t,$$

which is the equation for simple harmonic motion where the amplitude of vibration is x_0 .

Torsional Free Vibration

$$\ddot{\theta} + \omega_n^2 \theta = 0, \text{ where}$$

$$\omega_n = \sqrt{k_t/I} = \sqrt{GJ/IL},$$

k_t = the torsional spring constant = GJ/L ,

I = the mass moment of inertia of the body,

G = the shear modulus,

J = the area polar moment of inertia of the round shaft cross section, and

L = the length of the round shaft.

The solution to the equation of motion is

$$\theta = \theta_0 \cos \omega_n t + (\dot{\theta}_0/\omega_n) \sin \omega_n t, \text{ where}$$

θ_0 = the initial angle of rotation and

$\dot{\theta}_0$ = the initial angular velocity.

The undamped circular natural frequency of torsional vibration is

$$\omega_n = \sqrt{GJ/IL}$$

The period of torsional vibration is

$$\tau = 2\pi/\omega_n = 2\pi\sqrt{IL/GJ}$$

Figure	Area & Centroid	Area Moment of Inertia	(Radius of Gyration) ²	Product of Inertia
	$A = bh/2$ $x_c = 2b/3$ $y_c = h/3$	$I_{x_c} = bh^3/36$ $I_{y_c} = b^3h/36$ $I_x = bh^3/12$ $I_y = b^3h/4$	$r_{x_c}^2 = h^2/18$ $r_{y_c}^2 = b^2/18$ $r_x^2 = h^2/6$ $r_y^2 = b^2/2$	$I_{x_c y_c} = Abh/36 = b^2h^2/72$ $I_{xy} = Abh/4 = b^2h^2/8$
	$A = bh/2$ $x_c = b/3$ $y_c = h/3$	$I_{x_c} = bh^3/36$ $I_{y_c} = b^3h/36$ $I_x = bh^3/12$ $I_y = b^3h/12$	$r_{x_c}^2 = h^2/18$ $r_{y_c}^2 = b^2/18$ $r_x^2 = h^2/6$ $r_y^2 = b^2/6$	$I_{x_c y_c} = -Abh/36 = -b^2h^2/72$ $I_{xy} = Abh/12 = b^2h^2/24$
	$A = bh/2$ $x_c = (a+b)/3$ $y_c = h/3$	$I_{x_c} = bh^3/36$ $I_{y_c} = [bh(b^2 - ab + a^2)]/36$ $I_x = bh^3/12$ $I_y = [bh(b^2 + ab + a^2)]/12$	$r_{x_c}^2 = h^2/18$ $r_{y_c}^2 = (b^2 - ab + a^2)/18$ $r_x^2 = h^2/6$ $r_y^2 = (b^2 + ab + a^2)/6$	$I_{x_c y_c} = [Ah(2a - b)]/36$ $= [bh^2(2a - b)]/72$ $I_{xy} = [Ah(2a + b)]/12$ $= [bh^2(2a + b)]/24$
	$A = bh$ $x_c = b/2$ $y_c = h/2$	$I_{x_c} = bh^3/12$ $I_{y_c} = b^3h/12$ $I_x = bh^3/3$ $I_y = b^3h/3$ $J = [bh(b^2 + h^2)]/12$	$r_{x_c}^2 = h^2/12$ $r_{y_c}^2 = b^2/12$ $r_x^2 = h^2/3$ $r_y^2 = b^2/3$ $r_p^2 = (b^2 + h^2)/12$	$I_{x_c y_c} = 0$ $I_{xy} = Abh/4 = b^2h^2/4$
	$A = h(a+b)/2$ $y_c = \frac{h(2a+b)}{3(a+b)}$	$I_{x_c} = \frac{h^3(a^2 + 4ab + b^2)}{36(a+b)}$ $I_x = \frac{h^3(3a+b)}{12}$	$r_{x_c}^2 = \frac{h^2(a^2 + 4ab + b^2)}{18(a+b)}$ $r_x^2 = \frac{h^2(3a+b)}{6(a+b)}$	
	$A = ab \sin \theta$ $x_c = (b + a \cos \theta)/2$ $y_c = (a \sin \theta)/2$	$I_{x_c} = (a^3 b \sin^3 \theta)/12$ $I_{y_c} = [ab \sin \theta (b^2 + a^2 \cos^2 \theta)]/12$ $I_x = (a^3 b \sin^3 \theta)/3$ $I_y = [ab \sin \theta (b + a \cos \theta)^2]/3$ $- (a^2 b^2 \sin \theta \cos \theta)/6$	$r_{x_c}^2 = (a \sin \theta)^2 / 12$ $r_{y_c}^2 = (b^2 + a^2 \cos^2 \theta) / 12$ $r_x^2 = (a \sin \theta)^2 / 3$ $r_y^2 = (b + a \cos \theta)^2 / 3$ $- (ab \cos \theta) / 6$	$I_{x_c y_c} = (a^3 b \sin^2 \theta \cos \theta) / 12$

Figure	Area & Centroid	Area Moment of Inertia	(Radius of Gyration) ²	Product of Inertia
	$A = \pi a^2$ $x_c = a$ $y_c = a$	$I_{x_c} = I_{y_c} = \pi a^4 / 4$ $I_x = I_y = 5\pi a^4 / 4$ $J = \pi a^4 / 2$	$r_{x_c}^2 = r_{y_c}^2 = a^2 / 4$ $r_x^2 = r_y^2 = 5a^2 / 4$ $r_p^2 = a^2 / 2$	$I_{x_c y_c} = 0$ $I_{xy} = Aa^2$
	$A = \pi(a^2 - b^2)$ $x_c = a$ $y_c = a$	$I_{x_c} = I_{y_c} = \pi(a^4 - b^4) / 4$ $I_x = I_y = \frac{5\pi a^4}{4} - \pi a^2 b^2 - \frac{\pi b^4}{4}$ $J = \pi(a^4 - b^4) / 2$	$r_{x_c}^2 = r_{y_c}^2 = (a^2 + b^2) / 4$ $r_x^2 = r_y^2 = (5a^2 + b^2) / 4$ $r_p^2 = (a^2 + b^2) / 2$	$I_{x_c y_c} = 0$ $I_{xy} = Aa^2 - \pi a^2(a^2 - b^2)$
	$A = \pi a^2 / 2$ $x_c = a$ $y_c = 4a / (3\pi)$	$I_{x_c} = \frac{a^4(9\pi^2 - 64)}{72\pi}$ $I_{y_c} = \pi a^4 / 8$ $I_x = \pi a^4 / 8$ $I_y = 5\pi a^4 / 8$	$r_{x_c}^2 = \frac{a^2(9\pi^2 - 64)}{36\pi^2}$ $r_{y_c}^2 = a^2 / 4$ $r_x^2 = a^2 / 4$ $r_y^2 = 5a^2 / 4$	$I_{x_c y_c} = 0$ $I_{xy} = 2a^2 / 3$
<p>CIRCULAR SECTOR</p>	$A = a^2 \theta$ $x_c = \frac{2a \sin \theta}{3 \theta}$ $y_c = 0$	$I_x = \frac{a^4(\theta - \sin \theta \cos \theta)}{4}$ $I_y = \frac{a^4(\theta + \sin \theta \cos \theta)}{4}$	$r_x^2 = \frac{a^2(\theta - \sin \theta \cos \theta)}{4 \theta}$ $r_y^2 = \frac{a^2(\theta + \sin \theta \cos \theta)}{4 \theta}$	$I_{x_c y_c} = 0$ $I_{xy} = 0$
<p>CIRCULAR SEGMENT</p>	$A = a^2 \left(\theta - \frac{\sin 2\theta}{2} \right)$ $x_c = \frac{2a \sin^3 \theta}{3(\theta - \sin \theta \cos \theta)}$ $y_c = 0$	$I_x = \frac{Aa^2}{4} \left[1 - \frac{2\sin^3 \theta \cos \theta}{3\theta - 3\sin \theta \cos \theta} \right]$ $I_y = \frac{Aa^2}{4} \left[1 + \frac{2\sin^3 \theta \cos \theta}{\theta - \sin \theta \cos \theta} \right]$	$r_x^2 = \frac{a^2}{4} \left[1 - \frac{2\sin^3 \theta \cos \theta}{3\theta - 3\sin \theta \cos \theta} \right]$ $r_y^2 = \frac{a^2}{4} \left[1 + \frac{2\sin^3 \theta \cos \theta}{\theta - \sin \theta \cos \theta} \right]$	$I_{x_c y_c} = 0$ $I_{xy} = 0$

Figure	Area & Centroid	Area Moment of Inertia	(Radius of Gyration) ²	Product of Inertia
 <p>PARABOLA</p>	$A = 4ab/3$ $x_c = 3a/5$ $y_c = 0$	$I_{x_c} = I_x = 4ab^3/15$ $I_{y_c} = 16a^3b/175$ $I_y = 4a^3b/7$	$r_{x_c}^2 = r_x^2 = b^2/5$ $r_{y_c}^2 = 12a^2/175$ $r_y^2 = 3a^2/7$	$I_{x_c y_c} = 0$ $I_{xy} = 0$
 <p>HALF A PARABOLA</p>	$A = 2ab/3$ $x_c = 3a/5$ $y_c = 3b/8$	$I_x = 2ab^3/15$ $I_y = 2ab^3/7$	$r_x^2 = b^2/5$ $r_y^2 = 3a^2/7$	$I_{xy} = Aab/4 = a^2b^2$
 <p>nth DEGREE PARABOLA</p>	$A = bh/(n+1)$ $x_c = \frac{n+1}{n+2}b$ $y_c = \frac{h}{2} \frac{n+1}{2n+1}$	$I_x = \frac{bh^3}{3(3n+1)}$ $I_y = \frac{hb^3}{n+3}$	$r_x^2 = \frac{h^2(n+1)}{3(3n+1)}$ $r_y^2 = \frac{n+1}{n+3}b^2$	
 <p>nth DEGREE PARABOLA</p>	$A = \frac{n}{n+1}bh$ $x_c = \frac{n+1}{2n+1}b$ $y_c = \frac{n+1}{2(n+2)}h$	$I_x = \frac{n}{3(n+3)}bh^3$ $I_y = \frac{n}{3n+1}b^3h$	$r_x^2 = \frac{n+1}{3(n+1)}h^2$ $r_y^2 = \frac{n+1}{3n+1}b^2$	

Figure	Mass & Centroid	Mass Moment of Inertia	(Radius of Gyration) ²	Product of Inertia
	$M = \rho LA$ $x_c = L/2$ $y_c = 0$ $z_c = 0$ $A =$ cross-sectional area of rod $\rho =$ mass/vol.	$I_x = I_{x_c} = 0$ $I_{y_c} = I_{z_c} = ML^2/12$ $I_y = I_z = ML^2/3$	$r_x^2 = r_{x_c}^2 = 0$ $r_{y_c}^2 = r_{z_c}^2 = L^2/12$ $r_y^2 = r_z^2 = L^2/3$	$I_{x_c y_c}, \text{ etc.} = 0$ $I_{xy}, \text{ etc.} = 0$
	$M = 2\pi R\rho A$ $x_c = R =$ mean radius $y_c = R =$ mean radius $z_c = 0$ $A =$ cross-sectional area of ring $\rho =$ mass/vol.	$I_{x_c} = I_{y_c} = MR^2/2$ $I_{z_c} = MR^2$ $I_x = I_y = 3MR^2/2$ $I_z = 3MR^2$	$r_{x_c}^2 = r_{y_c}^2 = R^2/2$ $r_{z_c}^2 = R^2$ $r_x^2 = r_y^2 = 3R^2/2$ $r_z^2 = 3R^2$	$I_{x_c y_c}, \text{ etc.} = 0$ $I_{z_c z_c} = MR^2$ $I_{xz} = I_{yz} = 0$
	$M = \pi R^2 \rho h$ $x_c = 0$ $y_c = h/2$ $z_c = 0$ $\rho =$ mass/vol.	$I_{x_c} = I_{z_c} = M(3R^2 + h^2)/12$ $I_{y_c} = I_y = MR^2/2$ $I_x = I_z = M(3R^2 + 4h^2)/12$	$r_{x_c}^2 = r_{z_c}^2 = (3R^2 + h^2)/12$ $r_{y_c}^2 = r_y^2 = R^2/2$ $r_x^2 = r_z^2 = (3R^2 + 4h^2)/12$	$I_{x_c y_c}, \text{ etc.} = 0$ $I_{xy}, \text{ etc.} = 0$
	$M = \pi(R_1^2 - R_2^2)\rho h$ $x_c = 0$ $y_c = h/2$ $z_c = 0$ $\rho =$ mass/vol.	$I_{x_c} = I_{z_c} = M(3R_1^2 + 3R_2^2 + h^2)/12$ $I_{y_c} = I_y = M(R_1^2 + R_2^2)/2$ $I_x = I_z = M(3R_1^2 + 3R_2^2 + 4h^2)/12$	$r_{x_c}^2 = r_{z_c}^2 = (3R_1^2 + 3R_2^2 + h^2)/12$ $r_{y_c}^2 = r_y^2 = (R_1^2 + R_2^2)/2$ $r_x^2 = r_z^2 = (3R_1^2 + 3R_2^2 + 4h^2)/12$	$I_{x_c y_c}, \text{ etc.} = 0$ $I_{xy}, \text{ etc.} = 0$
	$M = \frac{4}{3}\pi R^3 \rho$ $x_c = 0$ $y_c = 0$ $z_c = 0$ $\rho =$ mass/vol.	$I_{x_c} = I_x = 2MR^2/5$ $I_{y_c} = I_y = 2MR^2/5$ $I_{z_c} = I_z = 2MR^2/5$	$r_{x_c}^2 = r_x^2 = 2R^2/5$ $r_{y_c}^2 = r_y^2 = 2R^2/5$ $r_{z_c}^2 = r_z^2 = 2R^2/5$	$I_{x_c y_c}, \text{ etc.} = 0$

MECHANICS OF MATERIALS

UNIAXIAL STRESS-STRAIN

Stress-Strain Curve for Mild Steel

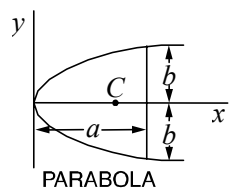
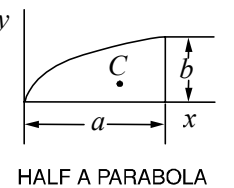
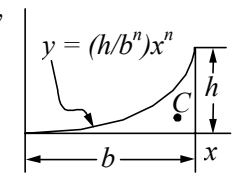
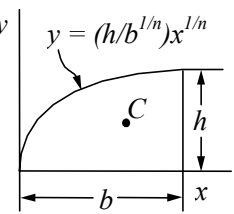
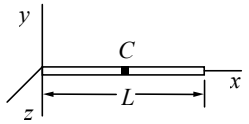
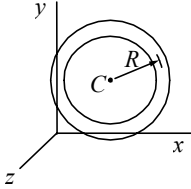
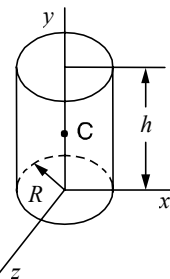
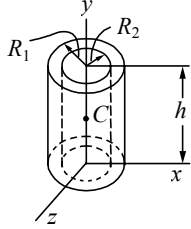
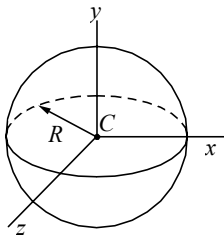
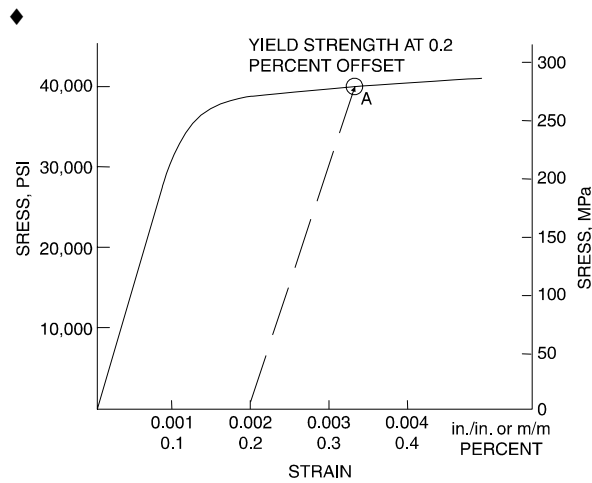

The slope of the linear portion of the curve equals the modulus of elasticity.

Engineering Strain

$$\epsilon = \Delta L / L_0, \text{ where}$$

ϵ = engineering strain (units per unit),

ΔL = change in length (units) of member,

L_0 = original length (units) of member,

ϵ_{pl} = plastic deformation (permanent), and

ϵ_{el} = elastic deformation (recoverable).

Equilibrium requirements: $\Sigma F = 0$; $\Sigma M = 0$

Determine geometric compatibility with the restraints. Use a linear force-deformation relationship;

$$F = k\delta.$$

DEFINITIONS

Shear Stress-Strain

$$\gamma = \tau / G, \text{ where}$$

γ = shear strain,

τ = shear stress, and

G = shear modulus (constant in linear force-deformation relationship).

$$G = \frac{E}{2(1 + \nu)}, \text{ where}$$

E = modulus of elasticity

ν = Poisson's ratio, and

= - (lateral strain)/(longitudinal strain).

Uniaxial Loading and Deformation

$$\sigma = P/A, \text{ where}$$

σ = stress on the cross section,

P = loading, and

A = cross-sectional area.

$$\epsilon = \delta/L, \text{ where}$$

δ = longitudinal deformation and

L = length of member.

$$E = \sigma/\epsilon = \frac{P/A}{\delta/L}$$

$$\delta = \frac{PL}{AE}$$

THERMAL DEFORMATIONS

$$\delta_t = \alpha L (T - T_o), \text{ where}$$

δ_t = deformation caused by a change in temperature,

α = temperature coefficient of expansion,

L = length of member,

T = final temperature, and

T_o = initial temperature.

CYLINDRICAL PRESSURE VESSEL

Cylindrical Pressure Vessel

For internal pressure only, the stresses at the inside wall are:

$$\sigma_t = P_i \frac{r_o^2 + r_i^2}{r_o^2 - r_i^2} \quad \text{and} \quad 0 > \sigma_r > -P_i$$

For external pressure only, the stresses at the outside wall are:

$$\sigma_t = -P_o \frac{r_o^2 + r_i^2}{r_o^2 - r_i^2} \quad \text{and} \quad 0 > \sigma_r > -P_o, \text{ where}$$

σ_t = tangential (hoop) stress,

σ_r = radial stress,

P_i = internal pressure,

P_o = external pressure,

r_i = inside radius, and

r_o = outside radius.

For vessels with end caps, the axial stress is:

$$\sigma_a = P_i \frac{r_i^2}{r_o^2 - r_i^2}$$

These are principal stresses.

♦ Flinn, Richard A. & Paul K. Trojan, *Engineering Materials & Their Applications*, 4th Ed. Copyright © 1990 by Houghton Mifflin Co. Figure used with permission.

When the thickness of the cylinder wall is about one-tenth or less, of inside radius, the cylinder can be considered as thin-walled. In which case, the internal pressure is resisted by the hoop stress

$$\sigma_t = \frac{P_i r}{t} \quad \text{and} \quad \sigma_a = \frac{P_i r}{2t}$$

where t = wall thickness.

STRESS AND STRAIN

Principal Stresses

For the special case of a *two-dimensional* stress state, the equations for principal stress reduce to

$$\sigma_a, \sigma_b = \frac{\sigma_x + \sigma_y}{2} \pm \sqrt{\left(\frac{\sigma_x - \sigma_y}{2}\right)^2 + \tau_{xy}^2}$$

$$\sigma_c = 0$$

The two nonzero values calculated from this equation are temporarily labeled σ_a and σ_b and the third value σ_c is always zero in this case. Depending on their values, the three roots are then labeled according to the convention: *algebraically largest* = σ_1 , *algebraically smallest* = σ_3 , *other* = σ_2 . A typical 2D stress element is shown below with all indicated components shown in their positive sense.

Mohr's Circle – Stress, 2D

To construct a Mohr's circle, the following sign conventions are used.

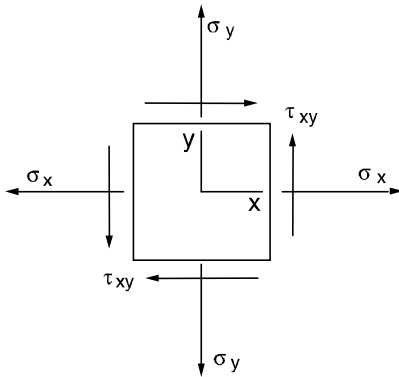

1. Tensile normal stress components are plotted on the horizontal axis and are considered positive. Compressive normal stress components are negative.
2. For constructing Mohr's circle only, shearing stresses are plotted above the normal stress axis when the pair of shearing stresses, acting on opposite and parallel faces of an element, forms a clockwise couple. Shearing stresses are plotted below the normal axis when the shear stresses form a counterclockwise couple.

The circle drawn with the center on the normal stress (horizontal) axis with center, C , and radius, R , where

$$C = \frac{\sigma_x + \sigma_y}{2}, \quad R = \sqrt{\left(\frac{\sigma_x - \sigma_y}{2}\right)^2 + \tau_{xy}^2}$$

The two nonzero principal stresses are then:

$$\sigma_a = C + R$$

$$\sigma_b = C - R$$

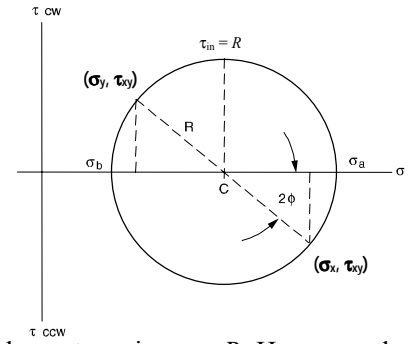

The maximum *inplane* shear stress is $\tau_{in} = R$. However, the maximum shear stress considering three dimensions is always

$$\tau_{max} = \frac{\sigma_1 - \sigma_3}{2}$$

Hooke's Law

Three-dimensional case:

$$\epsilon_x = (1/E)[\sigma_x - \nu(\sigma_y + \sigma_z)] \quad \gamma_{xy} = \tau_{xy}/G$$

$$\epsilon_y = (1/E)[\sigma_y - \nu(\sigma_z + \sigma_x)] \quad \gamma_{yz} = \tau_{yz}/G$$

$$\epsilon_z = (1/E)[\sigma_z - \nu(\sigma_x + \sigma_y)] \quad \gamma_{zx} = \tau_{zx}/G$$

Plane stress case ($\sigma_z = 0$):

$$\begin{cases} \epsilon_x \\ \epsilon_y \\ \tau_{xy} \end{cases} = \frac{E}{1-\nu^2} \begin{bmatrix} 1 & \nu & 0 \\ \nu & 1 & 0 \\ 0 & 0 & \frac{1-\nu}{2} \end{bmatrix} \begin{cases} \sigma_x \\ \sigma_y \\ \tau_{xy} \end{cases}$$

Uniaxial case ($\sigma_y = \sigma_z = 0$): $\sigma_x = E\epsilon_x$ or $\sigma = E\epsilon$, where

$\epsilon_x, \epsilon_y, \epsilon_z$ = normal strain,

$\sigma_x, \sigma_y, \sigma_z$ = normal stress,

$\gamma_{xy}, \gamma_{yz}, \gamma_{zx}$ = shear strain,

$\tau_{xy}, \tau_{yz}, \tau_{zx}$ = shear stress,

E = modulus of elasticity,

G = shear modulus, and

ν = Poisson's ratio.

STATIC LOADING FAILURE THEORIES

Maximum-Normal-Stress Theory

The maximum-normal-stress theory states that failure occurs when one of the three principal stresses equals the strength of the material. If $\sigma_1 > \sigma_2 > \sigma_3$, then the theory predicts that failure occurs whenever $\sigma_1 \geq S_t$ or $\sigma_3 \leq -S_c$ where S_t and S_c are the tensile and compressive strengths, respectively.

Maximum-Shear-Stress Theory

The maximum-shear-stress theory states that yielding begins when the maximum shear stress equals the maximum shear stress in a tension-test specimen of the same material when that specimen begins to yield. If $\sigma_1 \geq \sigma_2 \geq \sigma_3$, then the theory predicts that yielding will occur whenever $\tau_{max} \geq S_y/2$ where S_y is the yield strength.

Distortion-Energy Theory

The distortion-energy theory states that yielding begins whenever the distortion energy in a unit volume equals the distortion energy in the same volume when uniaxially stressed to the yield strength. The theory predicts that yielding will occur whenever

$$\left[\frac{(\sigma_1 - \sigma_2)^2 + (\sigma_2 - \sigma_3)^2 + (\sigma_1 - \sigma_3)^2}{2} \right]^{1/2} \geq S_y$$

TORSION

$$\gamma_{\phi z} = \lim_{\Delta z \rightarrow 0} r(\Delta\phi/\Delta z) = r(d\phi/dz)$$

The shear strain varies in direct proportion to the radius, from zero strain at the center to the greatest strain at the outside of the shaft. $d\phi/dz$ is the twist per unit length or the rate of twist.

$$\tau_{\phi z} = G \gamma_{\phi z} = Gr (d\phi/dz)$$

$$T = G (d\phi/dz) \int_A r^2 dA = GJ(d\phi/dz), \text{ where}$$

$J = \text{polar moment of inertia}$ (see table at end of DYNAMICS section).

$$\phi = \int_0^L \frac{T}{GJ} dz = \frac{TL}{GJ}, \text{ where}$$

ϕ = total angle (radians) of twist,

T = torque, and

L = length of shaft.

$$\tau_{\phi z} = Gr [T/(GJ)] = Tr/J$$

$$\frac{T}{\phi} = \frac{GJ}{L}, \text{ where}$$

T/ϕ gives the *twisting moment per radian of twist*. This is called the *torsional stiffness* and is often denoted by the symbol k or c .

For Hollow, Thin-Walled Shafts

$$\tau = \frac{T}{2A_m t}, \text{ where}$$

t = thickness of shaft wall and

A_m = the total mean area enclosed by the shaft measured to the midpoint of the wall.

BEAMS

Shearing Force and Bending Moment Sign Conventions

1. The bending moment is *positive* if it produces bending of the beam *concave upward* (compression in top fibers and tension in bottom fibers).
2. The shearing force is *positive* if the *right portion of the beam tends to shear downward with respect to the left*.

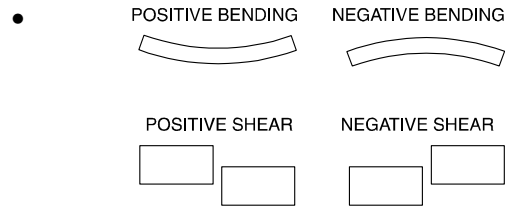

The relationship between the load (q), shear (V), and moment (M) equations are:

$$q(x) = -\frac{dV(x)}{dx}$$

$$V = \frac{dM(x)}{dx}$$

$$V_2 - V_1 = \int_{x_1}^{x_2} [-q(x)] dx$$

$$M_2 - M_1 = \int_{x_1}^{x_2} V(x) dx$$

Stresses in Beams

$$\epsilon_x = -y/\rho, \text{ where}$$

ρ = the radius of curvature of the deflected axis of the beam, and

y = the distance from the neutral axis to the longitudinal fiber in question.

Using the stress-strain relationship $\sigma = E\epsilon$,

Axial Stress: $\sigma_x = -Ey/\rho$, where

σ_x = the normal stress of the fiber located y -distance from the neutral axis.

$$1/\rho = M/(EI), \text{ where}$$

M = the moment at the section and

I = the *moment of inertia* of the cross-section.

$$\sigma_x = -My/I, \text{ where}$$

y = the distance from the neutral axis to the fiber location above or below the axis. Let $y = c$, where c = distance from the neutral axis to the outermost fiber of a symmetrical beam section.

$$\sigma_x = \pm Mc/I$$

Let $S = I/c$: then, $\sigma_x = \pm M/S$, where

S = the *elastic section modulus* of the beam member.

Transverse shear flow: $q = VQ/I$ and

Transverse shear stress: $\tau_{xy} = VQ/(Ib)$, where

q = shear flow,

τ_{xy} = shear stress on the surface,

V = shear force at the section,

b = width or thickness of the cross-section, and

$Q = A'\bar{y}'$, where

A' = area above the layer (or plane) upon which the desired transverse shear stress acts and

\bar{y}' = distance from neutral axis to area centroid.

• Timoshenko, S. & Gleason H. MacCullough, *Elements of Strength of Materials*, ©1949 by K. Van Nostrand Co. Used with permission from Wadsworth Publishing Co.

Deflection of Beams

Using $1/\rho = M/(EI)$,

$$EI \frac{d^2 y}{dx^2} = M, \text{ differential equation of deflection curve}$$

$$EI \frac{d^3 y}{dx^3} = dM(x)/dx = V$$

$$EI \frac{d^4 y}{dx^4} = dV(x)/dx = -q$$

Determine the deflection curve equation by double integration (apply boundary conditions applicable to the deflection and/or slope).

$$EI (dy/dx) = \int M(x) dx$$

$$EI y = \int \left[\int M(x) dx \right] dx$$

The constants of integration can be determined from the physical geometry of the beam.

COLUMNS

For long columns with pinned ends:

Euler's Formula

$$P_{cr} = \frac{\pi^2 EI}{\ell^2}, \text{ where}$$

P_{cr} = critical axial loading,

ℓ = unbraced column length.

substitute $I = r^2 A$:

$$\frac{P_{cr}}{A} = \frac{\pi^2 E}{(\ell/r)^2}, \text{ where}$$

r = radius of gyration and

ℓ/r = slenderness ratio for the column.

For further column design theory, see the **CIVIL ENGINEERING** and **MECHANICAL ENGINEERING** sections.

ELASTIC STRAIN ENERGY

If the strain remains within the elastic limit, the work done during deflection (extension) of a member will be transformed into potential energy and can be recovered.

If the final load is P and the corresponding elongation of a tension member is δ , then the total energy U stored is equal to the work W done during loading.

$$U = W = P\delta/2$$

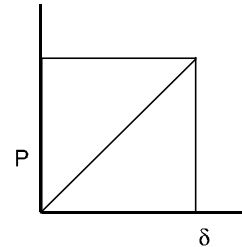

The strain energy per unit volume is

$$u = U/AL = \sigma^2/2E \quad (\text{for tension})$$

MATERIAL PROPERTIES

Material	Units	Steel	Aluminum	Cast Iron	Wood (Fir)
Modulus of Elasticity, E	Mpsi	30.0	10.0	14.5	1.6
	GPa	207.0	69.0	100.0	11.0
Modulus of Rigidity, G	Mpsi	11.5	3.8	6.0	0.6
	GPa	80.0	26.0	41.4	4.1
Poisson's Ratio, ν		0.30	0.33	0.21	0.33

Beam Deflection Formulas – Special Cases
 (δ is positive downward)

	$\delta = \frac{Pa^2}{6EI}(3x - a), \text{ for } x > a$ $\delta = \frac{Px^2}{6EI}(-x + 3a), \text{ for } x \leq a$	$\delta_{max} = \frac{Pa^2}{6EI}(3L - a)$	$\phi_{max} = \frac{Pa^2}{2EI}$
	$\delta = \frac{w_0 x^2}{24EI}(x^2 + 6L^2 - 4Lx)$	$\delta_{max} = \frac{w_0 L^4}{8EI}$	$\phi_{max} = \frac{w_0 L^3}{6EI}$
	$\delta = \frac{M_0 x^2}{2EI}$	$\delta_{max} = \frac{M_0 L^2}{2EI}$	$\phi_{max} = \frac{M_0 L}{EI}$
	$\delta = \frac{Pb}{6LEI} \left[\frac{L}{b}(x-a)^3 - x^3 + (L^2 - b^2)x \right], \text{ for } x > a$ $\delta = \frac{Pb}{6LEI} \left[-x^3 + (L^2 - b^2)x \right], \text{ for } x \leq a$	$\delta_{max} = \frac{Pb(L^2 - b^2)^{3/2}}{9\sqrt{3}LEI}$ <p align="center">at $x = \sqrt{\frac{L^2 - b^2}{3}}$</p>	$\phi_1 = \frac{Pab(2L - a)}{6LEI}$ $\phi_2 = \frac{Pab(2L - b)}{6LEI}$
	$\delta = \frac{w_0 x}{24EI}(L^3 - 2Lx^2 + x^3)$	$\delta_{max} = \frac{5w_0 L^4}{384EI}$	$\phi_1 = \phi_2 = \frac{w_0 L^3}{24EI}$
	$\delta = \frac{M_0 L x}{6EI} \left(1 - \frac{x^2}{L^2} \right)$	$\delta_{max} = \frac{M_0 L^2}{9\sqrt{3}EI}$ <p align="center">at $x = \frac{L}{\sqrt{3}}$</p>	$\phi_1 = \frac{M_0 L}{6EI}$ $\phi_2 = \frac{M_0 L}{3EI}$

FLUID MECHANICS

DENSITY, SPECIFIC VOLUME, SPECIFIC WEIGHT, AND SPECIFIC GRAVITY

The definitions of density, specific volume, specific weight, and specific gravity follow:

$$\begin{aligned}\rho &= \lim_{\Delta V \rightarrow 0} \Delta m / \Delta V \\ \gamma &= \lim_{\Delta V \rightarrow 0} \Delta W / \Delta V \\ \gamma &= \lim_{\Delta V \rightarrow 0} g \cdot \Delta m / \Delta V = \rho g\end{aligned}$$

also $SG = \gamma / \gamma_w = \rho / \rho_w$, where

- ρ = density (also mass density),
- Δm = mass of infinitesimal volume,
- ΔV = volume of infinitesimal object considered,
- γ = specific weight,
- ΔW = weight of an infinitesimal volume,
- SG = specific gravity, and
- ρ_w = mass density of water at standard conditions = 1,000 kg/m³ (62.43 lbm/ft³).

STRESS, PRESSURE, AND VISCOSITY

Stress is defined as

$$\tau(P) = \lim_{\Delta A \rightarrow 0} \Delta F / \Delta A, \text{ where}$$

- $\tau(P)$ = surface stress vector at point P ,
- ΔF = force acting on infinitesimal area ΔA , and
- ΔA = infinitesimal area at point P .

$$\tau_n = -p$$

$$\tau_t = \mu (dv/dy) \quad (\text{one-dimensional; i.e., } y), \text{ where}$$

τ_n and τ_t = the normal and tangential stress components at point P ,

p = the pressure at point P ,

μ = absolute dynamic viscosity of the fluid
N·s/m² [lbm/(ft·sec)],

dv = velocity at boundary condition, and

dy = normal distance, measured from boundary.

$$\nu = \mu / \rho, \text{ where}$$

ν = kinematic viscosity; m²/s (ft²/sec).

For a thin Newtonian fluid film and a linear velocity profile,

$$v(y) = Vy / \delta; dv/dy = V / \delta, \text{ where}$$

V = velocity of plate on film and

δ = thickness of fluid film.

For a power law (non-Newtonian) fluid

$$\tau_t = K (dv/dy)^n, \text{ where}$$

K = consistency index, and

n = power law index.

$n < 1 \equiv$ pseudo plastic

$n > 1 \equiv$ dilatant

SURFACE TENSION AND CAPILLARITY

Surface tension σ is the force per unit contact length

$$\sigma = F/L, \text{ where}$$

- σ = surface tension, force/length,
- F = surface force at the interface, and
- L = length of interface.

The capillary rise h is approximated by

$$h = 4\sigma \cos \beta / (\gamma d), \text{ where}$$

- h = the height of the liquid in the vertical tube,
- σ = the surface tension,
- β = the angle made by the liquid with the wetted tube wall,
- γ = specific weight of the liquid, and
- d = the diameter or the capillary tube.

THE PRESSURE FIELD IN A STATIC LIQUID AND MANOMETRY

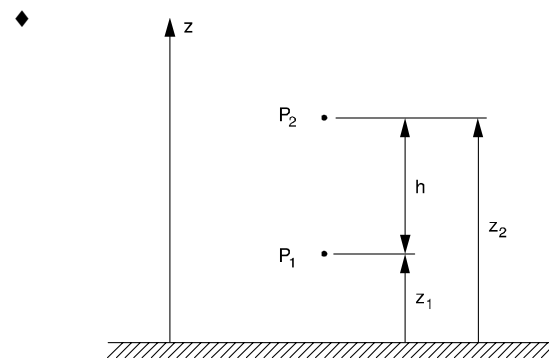

The difference in pressure between two different points is

$$p_2 - p_1 = -\gamma (z_2 - z_1) = -\gamma h$$

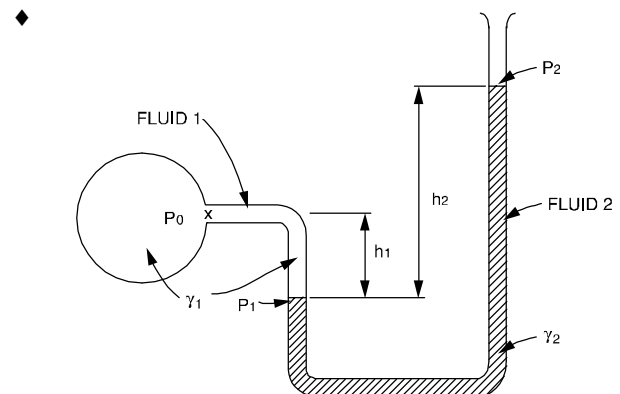

◆ Bober, W. & R.A. Kenyon, *Fluid Mechanics*, Copyright © 1980 by John Wiley & Sons, Inc. Diagrams reprinted by permission of William Bober & Richard A. Kenyon.

For a simple manometer,

$$p_o = p_2 + \gamma_2 h_2 - \gamma_1 h_1$$

Absolute pressure = atmospheric pressure + gage pressure reading

Absolute pressure = atmospheric pressure - vacuum gage pressure reading

Another device that works on the same principle as the manometer is the simple barometer.

$$p_{atm} = p_A = p_v + \gamma h = p_B + \gamma h$$

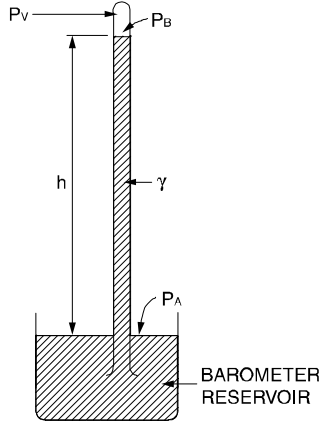

p_v = vapor pressure of the barometer fluid

FORCES ON SUBMERGED SURFACES AND THE CENTER OF PRESSURE

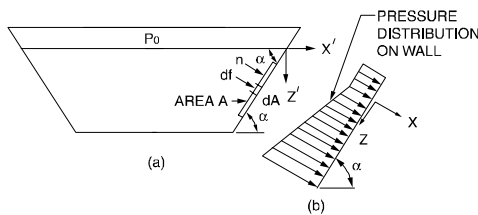

Forces on a submerged plane wall. (a) Submerged plane surface. (b) Pressure distribution.

The pressure on a point at a distance Z' below the surface is

$$p = p_o + \gamma Z', \text{ for } Z' \geq 0$$

If the tank were open to the atmosphere, the effects of p_o could be ignored.

The coordinates of the *center of pressure* CP are

$$y^* = (\gamma I_{y_c z_c} \sin \alpha) / (p_c A) \quad \text{and}$$

$$z^* = (\gamma I_y \sin \alpha) / (p_c A), \text{ where}$$

y^* = the y -distance from the centroid (C) of area (A) to the center of pressure,

z^* = the z -distance from the centroid (C) of area (A) to the center of pressure,

I_{y_c} and $I_{y_c z_c}$ = the moment and product of inertia of the area,

p_c = the pressure at the centroid of area (A), and

Z_c = the slant distance from the water surface to the centroid (C) of area (A).

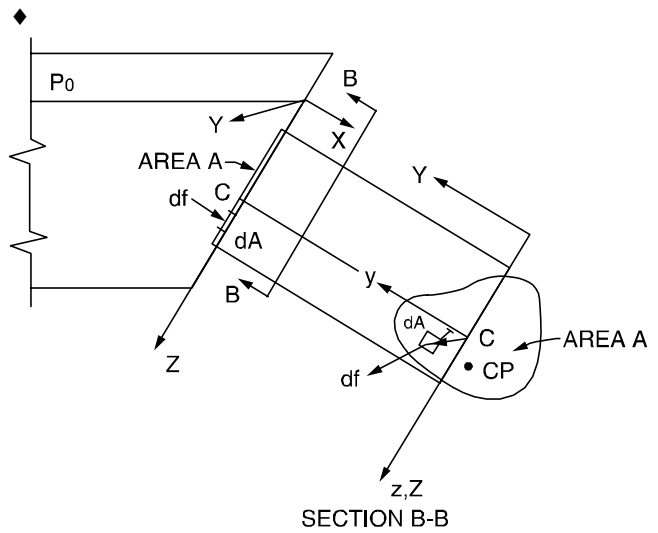

If the free surface is open to the atmosphere, then $p_o = 0$ and $p_c = \gamma Z_c \sin \alpha$.

$$y^* = I_{y_c z_c} / (AZ_c) \quad \text{and} \quad z^* = I_y / (AZ_c)$$

The force on the plate can be computed as

$$F = [p_1 A_v + (p_2 - p_1) A_v / 2] \mathbf{i} + V_f \gamma_f \mathbf{j}, \text{ where}$$

F = force on the plate,

p_1 = pressure at the top edge of the plate area,

p_2 = pressure at the bottom edge of the plate area,

A_v = vertical projection of the plate area,

V_f = volume of column of fluid above plate, and

γ_f = specific weight of the fluid.

ARCHIMEDES PRINCIPLE AND BUOYANCY

1. The buoyant force exerted on a submerged or floating body is equal to the weight of the fluid displaced by the body.
2. A floating body displaces a weight of fluid equal to its own weight; i.e., a floating body is in equilibrium.

The *center of buoyancy* is located at the centroid of the submerged portion of the body.

In the case of a body lying at the *interface of two immiscible fluids*, the buoyant force equals the sum of the weights of the fluids displaced by the body.

ONE-DIMENSIONAL FLOWS

The Continuity Equation So long as the flow Q is continuous, the *continuity equation*, as applied to one-dimensional flows, states that the flow passing two points (1 and 2) in a stream is equal at each point, $A_1 V_1 = A_2 V_2$.

$$Q = AV$$

$$\dot{m} = \rho Q = \rho AV, \text{ where}$$

Q = volumetric flow rate,

\dot{m} = mass flow rate,

♦ Bober, W. & R.A. Kenyon, *Fluid Mechanics*, Copyright © 1980 by John Wiley & Sons, Inc. Diagrams reprinted by permission of William Bober & Richard A. Kenyon.

- A = cross section of area of flow,
 V = average flow velocity, and
 ρ = the fluid density.

For steady, one-dimensional flow, m is a constant. If, in addition, the density is constant, then Q is constant.

The Field Equation is derived when the energy equation is applied to one-dimensional flows.

Assuming no friction losses and that no pump or turbine exists between sections 1 and 2 in the system,

$$\frac{p_2}{\gamma} + \frac{V_2^2}{2g} + z_2 = \frac{p_1}{\gamma} + \frac{V_1^2}{2g} + z_1, \text{ where}$$

- p_1, p_2 = pressure at sections 1 and 2,
 V_1, V_2 = average velocity of the fluid at the sections,
 z_1, z_2 = the vertical distance from a datum to the sections (the potential energy),
 γ = the specific weight of the fluid, and
 g = the acceleration of gravity.

FLOW OF A REAL FLUID

$$\frac{p_1}{\gamma} + z_1 + \frac{V_1^2}{2g} = \frac{p_2}{\gamma} + z_2 + \frac{V_2^2}{2g} + h_f$$

The pressure drop as fluid flows through a pipe of constant cross-section and which is held at a fixed elevation is

$$h_f = (p_1 - p_2)/\gamma, \text{ where}$$

h_f = the head loss, considered a friction effect, and all remaining terms are defined above.

Fluid Flow

The velocity distribution for **laminar flow in circular tubes or between planes** is

$$v = v_{max} \left[1 - \left(\frac{r}{R} \right)^2 \right], \text{ where}$$

- r = the distance (m) from the centerline,
 R = the radius (m) of the tube or half the distance between the parallel planes,
 v = the local velocity (m/s) at r , and
 v_{max} = the velocity (m/s) at the centerline of the duct.
 $v_{max} = 1.18V$, for fully turbulent flow
 (Re > 10,000)
 $v_{max} = 2V$, for circular tubes in laminar flow and
 $v_{max} = 1.5V$, for parallel planes in laminar flow, where
 V = the average velocity (m/s) in the duct.

The shear stress distribution is

$$\frac{\tau}{\tau_w} = \frac{r}{R}, \text{ where}$$

τ and τ_w are the shear stresses at radii r and R respectively.

The *drag force* F_D on **objects immersed in a large body of flowing fluid or objects moving through a stagnant fluid** is

$$F_D = \frac{C_D \rho V^2 A}{2}, \text{ where}$$

- C_D = the *drag coefficient* (see page 46),
 V = the velocity (m/s) of the undisturbed fluid, and
 A = the *projected area* (m^2) of bluff objects such as spheres, ellipsoids, and disks and plates, cylinders, ellipses, and air foils with axes perpendicular to the flow.

For **flat plates placed parallel with the flow**

$$C_D = 1.33/Re^{0.5} \quad (10^4 < Re < 5 \times 10^5)$$

$$C_D = 0.031/Re^{1/7} \quad (10^6 < Re < 10^9)$$

The characteristic length in the Reynolds Number (Re) is the length of the plate parallel with the flow. For bluff objects, the characteristic length is the largest linear dimension (diameter of cylinder, sphere, disk, etc.) which is perpendicular to the flow.

Reynolds Number

$$Re = VD\rho/\mu = VD/\nu$$

$$Re' = \frac{V^{(2-n)} D^n \rho}{K \left(\frac{3n+1}{4n} \right)^n 8^{(n-1)}}, \text{ where}$$

- ρ = the mass density,
 D = the diameter of the pipe or dimension of the fluid streamline,
 μ = the dynamic viscosity,
 ν = the kinematic viscosity,
 Re = the Reynolds number (Newtonian fluid),
 Re' = the Reynolds number (Power law fluid), and
 K and n are defined on page 38.

The critical Reynolds number $(Re)_c$ is defined to be the minimum Reynolds number at which a flow will turn turbulent.

Hydraulic Gradient (Grade Line)

The hydraulic gradient (grade line) is defined as an imaginary line above a pipe so that the vertical distance from the pipe axis to the line represents the *pressure head* at that point. If a row of piezometers were placed at intervals along the pipe, the grade line would join the water levels in the piezometer water columns.

Energy Line (Bernoulli Equation)

The Bernoulli equation states that the sum of the pressure, velocity, and elevation heads is constant. The energy line is this sum or the "total head line" above a horizontal datum.

The difference between the hydraulic grade line and the energy line is the $V^2/2g$ term.

STEADY, INCOMPRESSIBLE FLOW IN CONDUITS AND PIPES

The energy equation for incompressible flow is

$$\frac{p_1}{\gamma} + z_1 + \frac{V_1^2}{2g} = \frac{p_2}{\gamma} + z_2 + \frac{V_2^2}{2g} + h_f$$

If the cross-sectional area and the elevation of the pipe are the same at both sections (1 and 2), then $z_1 = z_2$ and $V_1 = V_2$. The pressure drop $p_1 - p_2$ is given by the following:

$$p_1 - p_2 = \gamma h_f$$

The Darcy equation is

$$h_f = f \frac{L}{D} \frac{V^2}{2g}, \text{ where}$$

- f = $f(\text{Re}, e/D)$, the friction factor,
- D = diameter of the pipe,
- L = length over which the pressure drop occurs,
- e = roughness factor for the pipe, and all other symbols are defined as before.

A chart that gives f versus Re for various values of e/D , known as a *Moody* or *Stanton diagram*, is available at the end of this section on page 45.

Friction Factor for Laminar Flow

The equation for Q in terms of the pressure drop Δp_f is the Hagen-Poiseuille equation. This relation is valid only for flow in the laminar region.

$$Q = \frac{\pi R^4 \Delta p_f}{8\mu L} = \frac{\pi D^4 \Delta p_f}{128\mu L}$$

Flow in Noncircular Conduits

Analysis of flow in conduits having a noncircular cross section uses the *hydraulic diameter* D_H , or the *hydraulic radius* R_H , as follows

$$R_H = \frac{\text{cross-sectional area}}{\text{wetted perimeter}} = \frac{D_H}{4}$$

Minor Losses in Pipe Fittings, Contractions, and Expansions

Head losses also occur as the fluid flows through pipe fittings (i.e., elbows, valves, couplings, etc.) and sudden pipe contractions and expansions.

$$\frac{p_1}{\gamma} + z_1 + \frac{V_1^2}{2g} = \frac{p_2}{\gamma} + z_2 + \frac{V_2^2}{2g} + h_f + h_{f, \text{fitting}}, \text{ where}$$

$$h_{f, \text{fitting}} = C \frac{V^2}{2g}$$

Specific fittings have characteristic values of C , which will be provided in the problem statement. A generally accepted *nominal value* for head loss in *well-streamlined gradual contractions* is

$$h_{f, \text{fitting}} = 0.04 V^2 / 2g$$

The *head loss* at either an *entrance* or *exit* of a pipe from or to a reservoir is also given by the $h_{f, \text{fitting}}$ equation. Values for C for various cases are shown as follows.

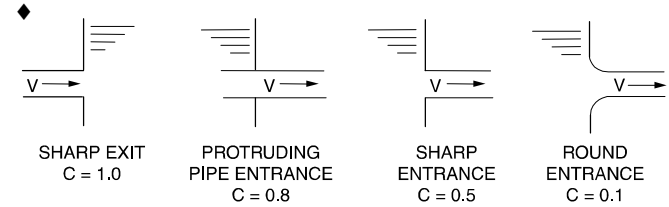

PUMP POWER EQUATION

$$\dot{W} = Q\gamma h / \eta, \text{ where}$$

- Q = quantity of flow (m^3/s or cfs),
- h = head (m or ft) the fluid has to be lifted,
- η = efficiency, and
- \dot{W} = power (watts or ft-lbf/sec).

THE IMPULSE-MOMENTUM PRINCIPLE

The resultant force in a given direction acting on the fluid equals the rate of change of momentum of the fluid.

$$\Sigma F = Q_2 \rho_2 V_2 - Q_1 \rho_1 V_1, \text{ where}$$

- ΣF = the resultant of all external forces acting on the control volume,
- $Q_1 \rho_1 V_1$ = the rate of momentum of the fluid flow entering the control volume in the same direction of the force, and
- $Q_2 \rho_2 V_2$ = the rate of momentum of the fluid flow leaving the control volume in the same direction of the force.

Pipe Bends, Enlargements, and Contractions

The force exerted by a flowing fluid on a bend, enlargement, or contraction in a pipe line may be computed using the impulse-momentum principle.

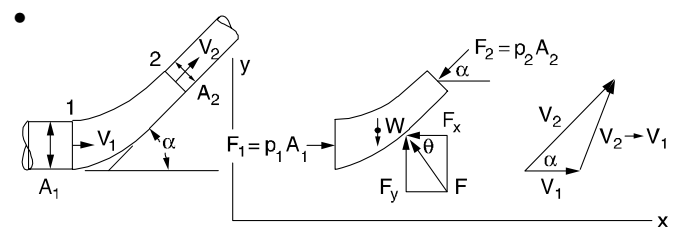

$$p_1 A_1 - p_2 A_2 \cos \alpha - F_x = Q\rho (V_2 \cos \alpha - V_1)$$

$$F_y - W - p_2 A_2 \sin \alpha = Q\rho (V_2 \sin \alpha - 0), \text{ where}$$

F = the force exerted by the bend on the fluid (the force exerted by the fluid on the bend is equal in magnitude and opposite in sign), F_x and F_y are the x -component and y -component of the force,

• Bober, W. & R.A. Kenyon, *Fluid Mechanics*, Copyright © 1980 by John Wiley & sons, Inc. Diagram reprinted by permission of William Bober & Richard A. Kenyon.

• Vennard, J.K., *Elementary Fluid Mechanics*, Copyright © 1954 by J.K. Vennard. Diagrams reprinted by permission of John Wiley & Sons, Inc.

p = the internal pressure in the pipe line,
 A = the cross-sectional area of the pipe line,
 W = the weight of the fluid,
 V = the velocity of the fluid flow,
 α = the angle the pipe bend makes with the horizontal,
 ρ = the density of the fluid, and
 Q = the quantity of fluid flow.

Jet Propulsion

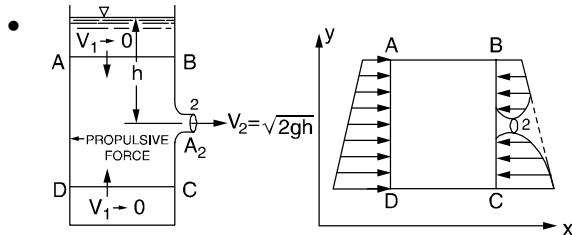

$$F = Q\rho(V_2 - 0)$$

$$F = 2\gamma h A_2, \text{ where}$$

F = the propulsive force,

γ = the specific weight of the fluid,

h = the height of the fluid above the outlet,

A_2 = the area of the nozzle tip,

$$Q = A_2\sqrt{2gh}, \text{ and}$$

$$V_2 = \sqrt{2gh}.$$

Deflectors and Blades

Fixed Blade

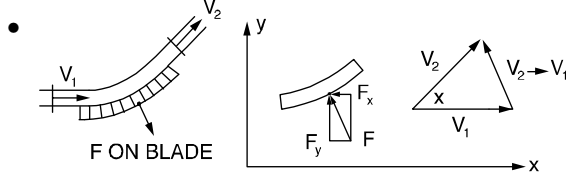

$$-F_x = Q\rho(V_2 \cos \alpha - V_1)$$

$$F_y = Q\rho(V_2 \sin \alpha - 0)$$

Moving Blade

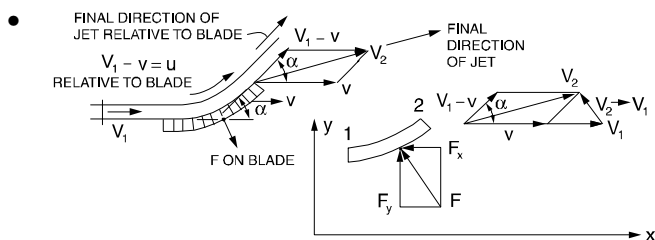

$$-F_x = Q\rho(V_{2x} - V_{1x})$$

$$= -Q\rho(V_1 - v)(1 - \cos \alpha)$$

$$F_y = Q\rho(V_{2y} - V_{1y})$$

$$= +Q\rho(V_1 - v) \sin \alpha, \text{ where}$$

v = the velocity of the blade.

Impulse Turbine

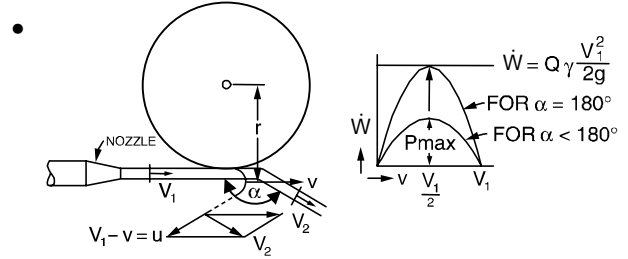

$$\dot{W} = Q\rho (V_1 - v)(1 - \cos \alpha) v, \text{ where}$$

\dot{W} = power of the turbine.

$$\dot{W}_{\max} = Q\rho (V_1^2/4)(1 - \cos \alpha)$$

When $\alpha = 180^\circ$,

$$\dot{W}_{\max} = (Q\rho V_1^2)/2 = (Q\gamma V_1^2)/2g$$

MULTIPATH PIPELINE PROBLEMS

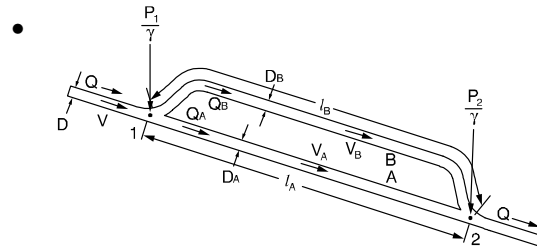

The same head loss occurs in each branch as in the combination of the two. The following equations may be solved simultaneously for V_A and V_B :

$$h_L = f_A \frac{l_A}{D_A} \frac{V_A^2}{2g} = f_B \frac{l_B}{D_B} \frac{V_B^2}{2g}$$

$$(\pi D^2/4)V = (\pi D_A^2/4)V_A + (\pi D_B^2/4)V_B$$

The flow Q can be divided into Q_A and Q_B when the pipe characteristics are known.

OPEN-CHANNEL FLOW AND/OR PIPE FLOW

Manning's Equation

$$V = (k/n)R^{2/3}S^{1/2}, \text{ where}$$

k = 1 for SI units,

k = 1.486 for USCS units,

V = velocity (m/s, ft/sec),

n = roughness coefficient,

R = hydraulic radius (m, ft), and

S = slope of energy grade line (m/m, ft/ft).

Hazen-Williams Equation

$$V = k_1 C R^{0.63} S^{0.54}, \text{ where}$$

C = roughness coefficient,

k_1 = 0.849 for SI units, and

k_1 = 1.318 for USCS units.

Other terms defined as above.

• Vennard, J.K., *Elementary Fluid Mechanics*, Copyright © 1954 by J.K. Vennard. Diagrams reprinted by permission of John Wiley & Sons, Inc.

MACH NUMBER

The speed of sound c in an ideal gas is given by

$$c = \sqrt{kRT}, \text{ where}$$

$$k = c_p/c_v.$$

This shows that the acoustic velocity in an ideal gas depends only on its temperature.

The mach number Ma is a ratio of the fluid velocity V to the speed of sound:

$$Ma = V/c$$

FLUID MEASUREMENTS

The Pitot Tube – From the stagnation pressure equation for an *incompressible fluid*,

$$V = \sqrt{(2/\rho)(p_o - p_s)} = \sqrt{2g(p_o - p_s)/\gamma}, \text{ where}$$

V = the velocity of the fluid,

p_o = the stagnation pressure, and

p_s = the static pressure of the fluid at the elevation where the measurement is taken.

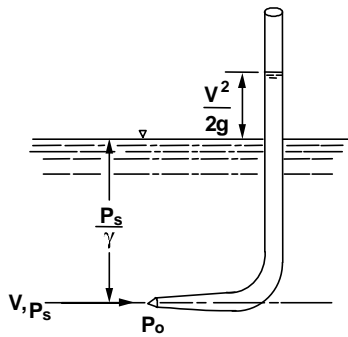

For a *compressible fluid*, use the above incompressible fluid equation if the mach number ≤ 0.3 .

Venturi Meters

$$Q = \frac{C_v A_2}{\sqrt{1 - (A_2/A_1)^2}} \sqrt{2g \left(\frac{p_1}{\gamma} + z_1 - \frac{p_2}{\gamma} - z_2 \right)}, \text{ where}$$

C_v = the coefficient of velocity.

The above equation is for *incompressible fluids*.

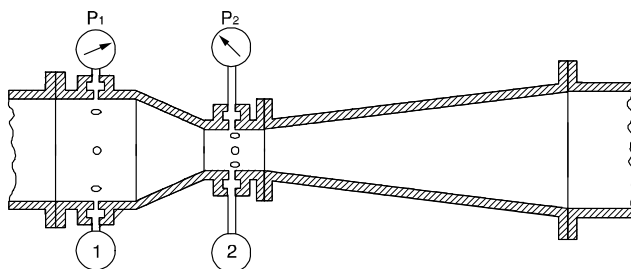

Orifices The cross-sectional area at the vena contracta A_2 is characterized by a *coefficient of contraction* C_c and given by $C_c A$.

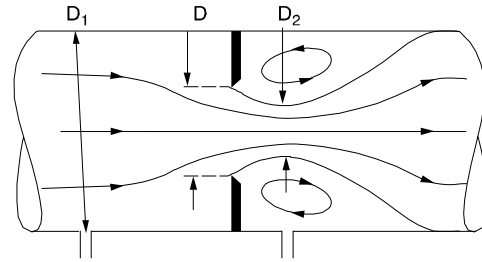

$$Q = CA \sqrt{2g \left(\frac{p_1}{\gamma} + z_1 - \frac{p_2}{\gamma} - z_2 \right)}$$

where C , the *coefficient of the meter*, is given by

$$C = \frac{C_v C_c}{\sqrt{1 - C_c^2 (A/A_1)^2}}$$

ORIFICES AND THEIR NOMINAL COEFFICIENTS				
	SHARP EDGED	ROUNDED	SHORT TUBE	BORDA
C	0.61	0.98	0.80	0.51
C_c	0.62	1.00	1.00	0.52
C_v	0.98	0.98	0.80	0.98

Submerged Orifice operating under steady-flow conditions:

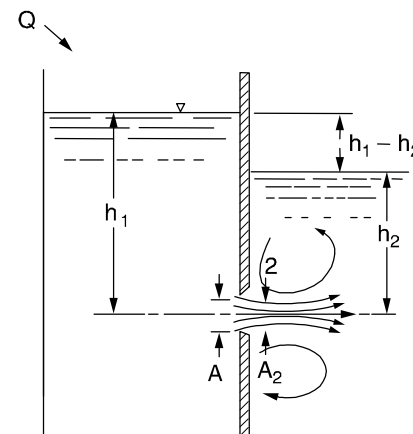

$$Q = A_2 V_2 = C_c C_v A \sqrt{2g(h_1 - h_2)} = CA \sqrt{2g(h_1 - h_2)}$$

in which the product of C_c and C_v is defined as the *coefficient of discharge* of the orifice.

• Vennard, J.K., *Elementary Fluid Mechanics*, Copyright © 1954 by J.K. Vennard. Diagrams reprinted by permission of John Wiley & Sons, Inc.

Orifice Discharging Freely Into Atmosphere

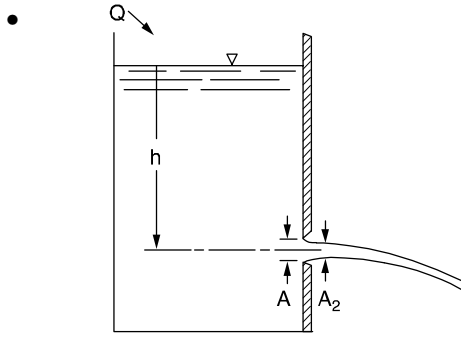

$$Q = CA\sqrt{2gh}$$

in which h is measured from the liquid surface to the centroid of the orifice opening.

DIMENSIONAL HOMOGENEITY AND DIMENSIONAL ANALYSIS

Equations that are in a form that do not depend on the fundamental units of measurement are called *dimensionally homogeneous* equations. A special form of the dimensionally homogeneous equation is one that involves only *dimensionless groups* of terms.

Buckingham's Theorem: The *number of independent dimensionless groups* that may be employed to describe a phenomenon known to involve n variables is equal to the number $(n - \bar{r})$, where \bar{r} is the number of basic dimensions (i.e., M, L, T) needed to express the variables dimensionally.

SIMILITUDE

In order to use a model to simulate the conditions of the prototype, the model must be *geometrically*, *kinematically*, and *dynamically similar* to the prototype system.

To obtain dynamic similarity between two flow pictures, all independent force ratios that can be written must be the same in both the model and the prototype. Thus, dynamic similarity between two flow pictures (when all possible forces are acting) is expressed in the five simultaneous equations below.

$$\left[\frac{F_I}{F_P}\right]_p = \left[\frac{F_I}{F_P}\right]_m = \left[\frac{\rho V^2}{p}\right]_p = \left[\frac{\rho V^2}{p}\right]_m$$

$$\left[\frac{F_I}{F_V}\right]_p = \left[\frac{F_I}{F_V}\right]_m = \left[\frac{Vl\rho}{\mu}\right]_p = \left[\frac{Vl\rho}{\mu}\right]_m = [Re]_p = [Re]_m$$

$$\left[\frac{F_I}{F_G}\right]_p = \left[\frac{F_I}{F_G}\right]_m = \left[\frac{V^2}{lg}\right]_p = \left[\frac{V^2}{lg}\right]_m = [Fr]_p = [Fr]_m$$

$$\left[\frac{F_I}{F_E}\right]_p = \left[\frac{F_I}{F_E}\right]_m = \left[\frac{\rho V^2}{E_v}\right]_p = \left[\frac{\rho V^2}{E_v}\right]_m = [Ca]_p = [Ca]_m$$

$$\left[\frac{F_I}{F_T}\right]_p = \left[\frac{F_I}{F_T}\right]_m = \left[\frac{\rho l V^2}{\sigma}\right]_p = \left[\frac{\rho l V^2}{\sigma}\right]_m = [We]_p = [We]_m$$

where

the subscripts p and m stand for *prototype* and *model* respectively, and

- F_I = inertia force,
- F_P = pressure force,
- F_V = viscous force,
- F_G = gravity force,
- F_E = elastic force,
- F_T = surface tension force,
- Re = Reynolds number,
- We = Weber number,
- Ca = Cauchy number,
- Fr = Froude number,
- l = characteristic length,
- V = velocity,
- ρ = density,
- σ = surface tension,
- E_v = bulk modulus,
- μ = dynamic viscosity,
- p = pressure, and
- g = acceleration of gravity.

$$Re = \frac{VD\rho}{\mu} = \frac{VD}{\nu}$$

PROPERTIES OF WATER^f

Temperature °C	Specific Weight ^a , γ , kN/m ³	Density ^a , ρ , kg/m ³	Viscosity ^a , μ , $\mu \times 10^3$, Pa·s	Kinematic Viscosity ^a , ν , $\nu \times 10^6$, m ² /s	Vapor Pressure ^e , P_v , kPa
0	9.805	999.8	1.781	1.785	0.61
5	9.807	1000.0	1.518	1.518	0.87
10	9.804	999.7	1.307	1.306	1.23
15	9.798	999.1	1.139	1.139	1.70
20	9.789	998.2	1.002	1.003	2.34
25	9.777	997.0	0.890	0.893	3.17
30	9.764	995.7	0.798	0.800	4.24
40	9.730	992.2	0.653	0.658	7.38
50	9.689	988.0	0.547	0.553	12.33
60	9.642	983.2	0.466	0.474	19.92
70	9.589	977.8	0.404	0.413	31.16
80	9.530	971.8	0.354	0.364	47.34
90	9.466	965.3	0.315	0.326	70.10
100	9.399	958.4	0.282	0.294	101.33

^aFrom "Hydraulic Models," *A.S.C.E. Manual of Engineering Practice*, No. 25, A.S.C.E., 1942. See footnote 2.

^cFrom J.H. Keenan and F.G. Keyes, *Thermodynamic Properties of Steam*, John Wiley & Sons, 1936.

^fCompiled from many sources including those indicated, *Handbook of Chemistry and Physics*, 54th Ed., The CRC Press, 1973, and *Handbook of Tables for Applied Engineering Science*, The Chemical Rubber Co., 1970.

²Here, if $E/10^6 = 1.98$ then $E = 1.98 \times 10^6$ kPa, while if $\mu \times 10^3 = 1.781$, then $\mu = 1.781 \times 10^3$ Pa·s, and so on. Vennard, J.K. and Robert L. Street, *Elementary Fluid Mechanics*, Copyright 1954, John Wiley & Sons, Inc.

• Vennard, J.K., *Elementary Fluid Mechanics*, Copyright © 1954 by J.K. Vennard. Diagrams reprinted by permission of John Wiley & Sons, Inc

MOODY (STANTON) DIAGRAM

Reprinted by permission of ASHRAE.

	e , (ft)	e , (mm)
Riveted steel	0.003-0.03	0.9-9.0
Concrete	0.001-0.01	0.3-3.0
Cast iron	0.00085	0.25
Galvanized iron	0.0005	0.15
Commercial steel or wrought iron	0.00015	0.046
Drawn tubing	0.000005	0.0015

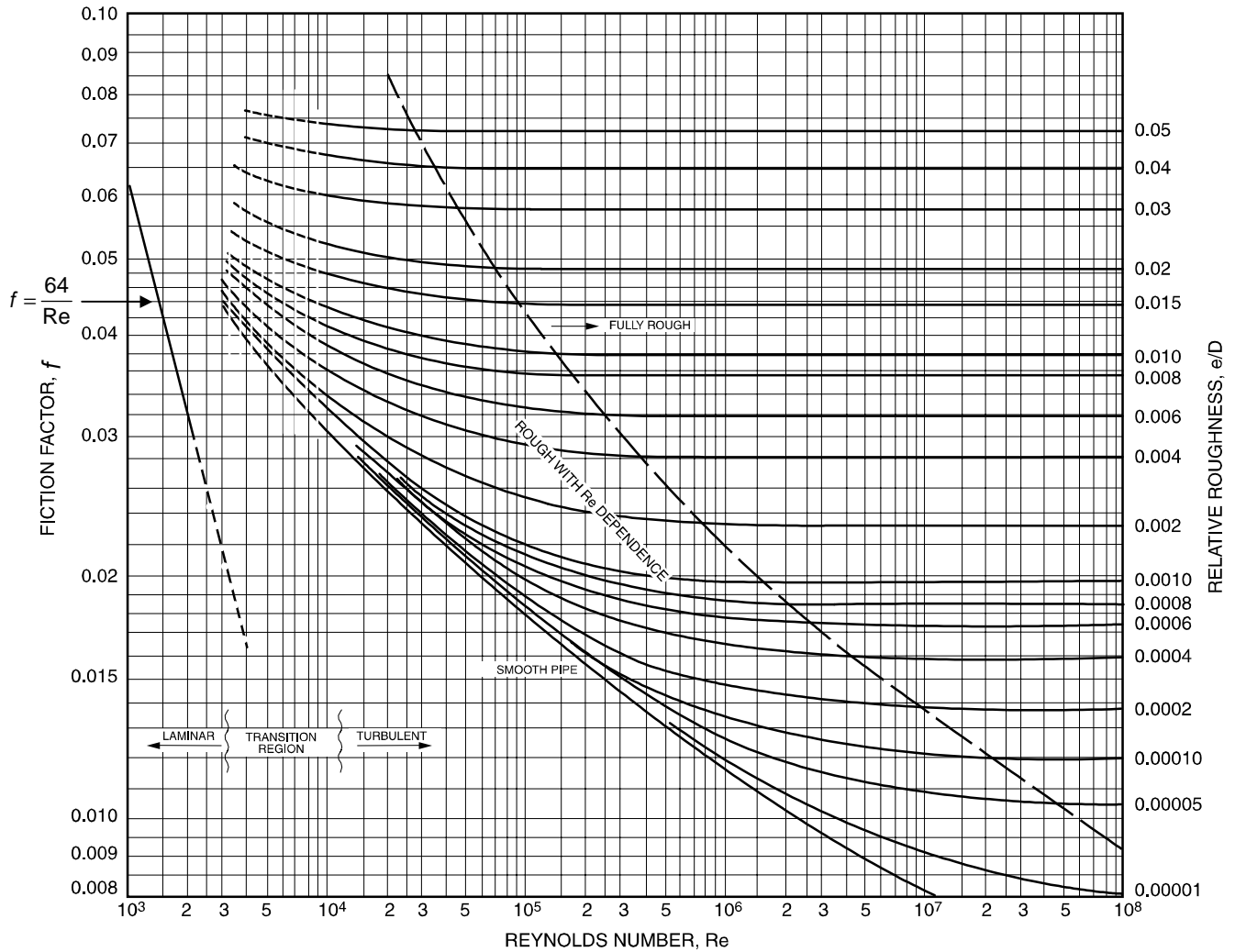

DRAG COEFFICIENTS FOR SPHERES, DISKS, AND CYLINDERS

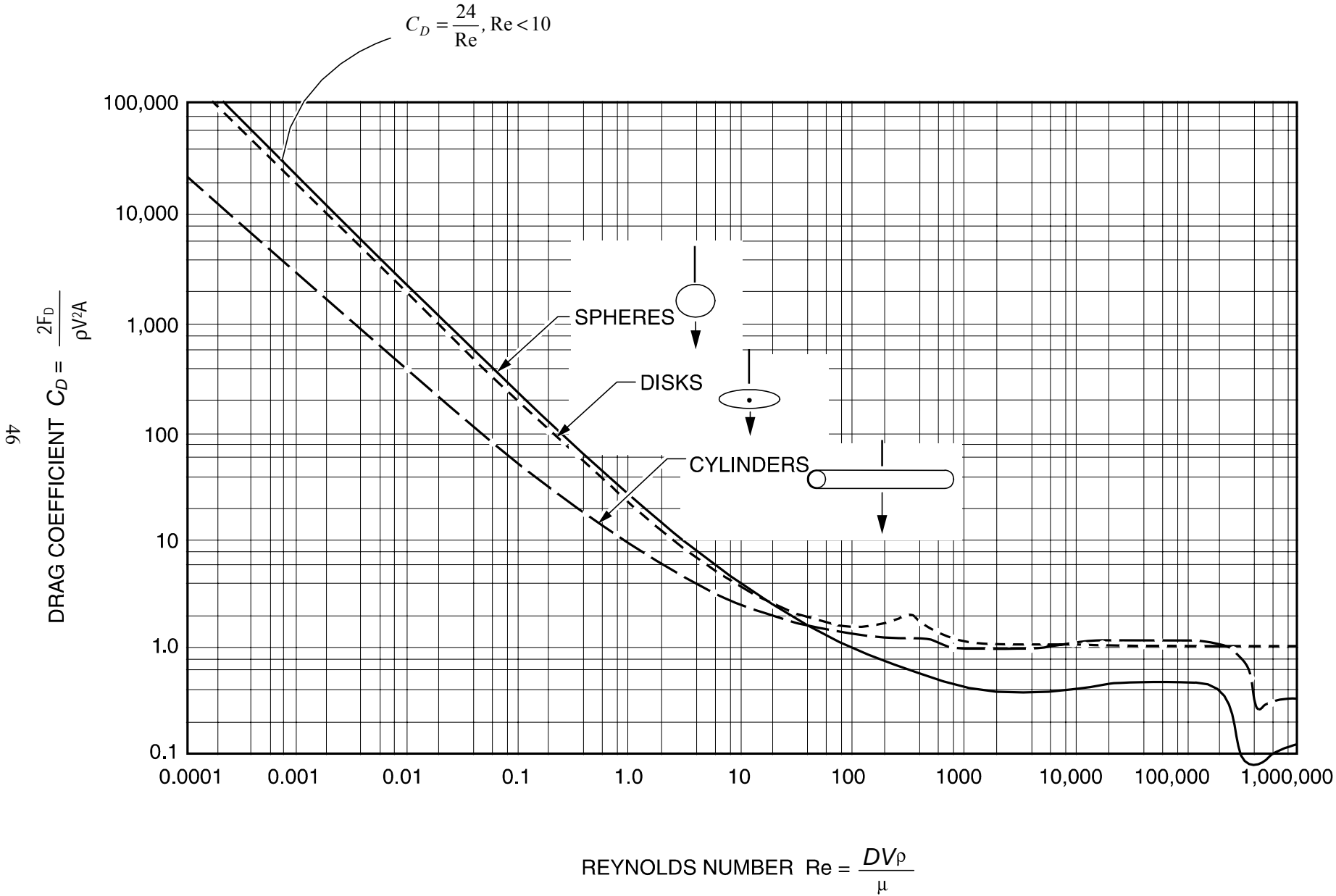

THERMODYNAMICS

PROPERTIES OF SINGLE-COMPONENT SYSTEMS

Nomenclature

1. Intensive properties are independent of mass.
2. Extensive properties are proportional to mass.
3. Specific properties are lower case (extensive/mass).

State Functions (properties)

Absolute Pressure, p (lbf/in² or Pa)

Absolute Temperature, T (°R or K)

Specific Volume, v (ft³/lbm or m³/kg)

Internal Energy, u (usually in Btu/lbm or kJ/kg)

Enthalpy, $h = u + Pv$ (same units as u)

Entropy, s [in Btu/(lbm-°R) or kJ/(kg·K)]

Gibbs Free Energy, $g = h - Ts$ (same units as u)

Helmholz Free Energy, $a = u - Ts$ (same units as u)

Heat Capacity at Constant Pressure, $c_p = \left(\frac{\partial h}{\partial T}\right)_p$

Heat Capacity at Constant Volume, $c_v = \left(\frac{\partial u}{\partial T}\right)_v$

Quality x (applies to liquid-vapor systems at saturation) is defined as the mass fraction of the vapor phase:

$$x = m_g / (m_g + m_f), \text{ where}$$

m_g = mass of vapor, and

m_f = mass of liquid.

Specific volume of a two-phase system can be written:

$$v = xv_g + (1-x)v_f \quad \text{or} \quad v = xv_{fg} + v_f, \text{ where}$$

v_f = specific volume of saturated liquid,

v_g = specific volume of saturated vapor, and

v_{fg} = specific volume change upon vaporization.

$$= v_g - v_f.$$

Similar expressions exist for u , h , and s :

$$u = xu_g + (1-x)u_f$$

$$h = xh_g + (1-x)h_f$$

$$s = xs_g + (1-x)s_f$$

For a simple substance, *specification of any two intensive, independent properties is sufficient* to fix all the rest.

For an ideal gas, $Pv = RT$ or $PV = mRT$, and

$$P_1v_1/T_1 = P_2v_2/T_2, \text{ where}$$

p = pressure,

v = specific volume,

m = mass of gas,

R = gas constant, and

T = temperature.

R is *specific to each gas* but can be found from

$$R = \frac{\bar{R}}{(\text{mol. wt.})}, \text{ where}$$

\bar{R} = the universal gas constant

$$= 1,545 \text{ ft-lbf}/(\text{lbmol}\cdot^\circ\text{R}) = 8,314 \text{ J}/(\text{kmol}\cdot\text{K}).$$

For *Ideal Gases*, $c_p - c_v = R$

Also, for *Ideal Gases*:

$$\left(\frac{\partial h}{\partial v}\right)_T = 0 \quad \left(\frac{\partial u}{\partial v}\right)_T = 0$$

For cold air standard, *heat capacities are assumed to be constant* at their room temperature values. In that case, the following are true:

$$\Delta u = c_v \Delta T; \quad \Delta h = c_p \Delta T$$

$$\Delta s = c_p \ln(T_2/T_1) - R \ln(P_2/P_1); \text{ and}$$

$$\Delta s = c_v \ln(T_2/T_1) + R \ln(v_2/v_1).$$

For heat capacities that are temperature dependent, the value to be used in the above equations for Δh is known as the mean heat capacity (\bar{c}_p) and is given by

$$\bar{c}_p = \frac{\int_{T_1}^{T_2} c_p dT}{T_2 - T_1}$$

Also, for *constant entropy* processes:

$$P_1v_1^k = P_2v_2^k; \quad T_1P_1^{(1-k)/k} = T_2P_2^{(1-k)/k}$$

$$T_1v_1^{(k-1)} = T_2v_2^{(k-1)}, \text{ where } k = c_p/c_v$$

FIRST LAW OF THERMODYNAMICS

The *First Law of Thermodynamics* is a statement of conservation of energy in a thermodynamic system. The net energy crossing the system boundary is equal to the change in energy inside the system.

Heat Q is *energy transferred* due to temperature difference and is considered positive if it is inward or added to the system.

Closed Thermodynamic System

(no mass crosses boundary)

$$Q - w = \Delta U + \Delta KE + \Delta PE$$

where

ΔKE = change in kinetic energy, and

ΔPE = change in potential energy.

Energy can cross the boundary only in the form of heat or work. Work can be boundary work, w_b , or other work forms (electrical work, etc.)

Work w is considered *positive if it is outward or work done* by the system.

Reversible boundary work is given by $w_b = \int P dv$.

Special Cases of Closed SystemsConstant Pressure (**Charles' Law**): $w_b = P\Delta v$ (ideal gas) $T/v = \text{constant}$ Constant Volume: $w_b = 0$ (ideal gas) $T/P = \text{constant}$ Isentropic (ideal gas), $Pv^k = \text{constant}$:

$$w = (P_2v_2 - P_1v_1)/(1 - k)$$

$$= R(T_2 - T_1)/(1 - k)$$

Constant Temperature (**Boyle's Law**):(ideal gas) $Pv = \text{constant}$

$$w_b = RT \ln(v_2/v_1) = RT \ln(P_1/P_2)$$

Polytropic (ideal gas), $Pv^n = \text{constant}$:

$$w = (P_2v_2 - P_1v_1)/(1 - n)$$

Open Thermodynamic System

(allowing mass to cross the boundary)

There is flow work (PV) done by mass entering the system.

The reversible flow work is given by:

$$w_{rev} = - \int v \, dP + \Delta KE + \Delta PE$$

First Law applies whether or not processes are reversible.

FIRST LAW (energy balance)

$$\sum \dot{m} [h_i + V_i^2/2 + gZ_i] - \sum \dot{m} [h_e + V_e^2/2 + gZ_e]$$

$$+ \dot{Q}_{in} - \dot{W}_{net} = d(m_s u_s)/dt, \text{ where}$$

 \dot{W}_{net} = rate of net or shaft work transfer, m_s = mass of fluid within the system, u_s = specific internal energy of system, and \dot{Q} = rate of heat transfer (neglecting kinetic and potential energy).Special Cases of Open SystemsConstant Volume: $w_{rev} = -v(P_2 - P_1)$ Constant Pressure: $w_{rev} = 0$ Constant Temperature: (ideal gas) $Pv = \text{constant}$:

$$w_{rev} = RT \ln(v_2/v_1) = RT \ln(P_1/P_2)$$

Isentropic (ideal gas): $Pv^k = \text{constant}$:

$$w_{rev} = k(P_2v_2 - P_1v_1)/(1 - k)$$

$$= kR(T_2 - T_1)/(1 - k)$$

$$w_{rev} = \frac{k}{k-1} RT_1 \left[1 - \left(\frac{P_2}{P_1} \right)^{(k-1)/k} \right]$$

Polytropic: $Pv^n = \text{constant}$

$$w_{rev} = n(P_2v_2 - P_1v_1)/(1 - n)$$

Steady-State Systems

The system does not change state with time. This assumption is valid for steady operation of turbines, pumps, compressors, throttling valves, nozzles, and heat exchangers, including boilers and condensers.

$$\sum \dot{m}_i (h_i + V_i^2/2 + gZ_i) - \sum \dot{m}_e (h_e + V_e^2/2 + gZ_e) + \dot{Q}_{in} - \dot{W}_{out} = 0 \text{ and}$$

$$\sum \dot{m}_i = \sum \dot{m}_e$$

where

 \dot{m} = mass flow rate (subscripts i and e refer to inlet and exit states of system), g = acceleration of gravity, Z = elevation, V = velocity, and \dot{w} = rate of work.Special Cases of Steady-Flow Energy Equation**Nozzles, Diffusers:** Velocity terms are significant. No elevation change, no heat transfer, and no work. Single mass stream.

$$h_i + V_i^2/2 = h_e + V_e^2/2$$

Efficiency (nozzle) = $\frac{V_e^2 - V_i^2}{2(h_i - h_{es})}$, where h_{es} = enthalpy at isentropic exit state.**Turbines, Pumps, Compressors:** Often considered adiabatic (no heat transfer). Velocity terms usually can be ignored. There are significant work terms and a single mass stream.

$$h_i = h_e + w$$

$$\text{Efficiency (turbine)} = \frac{h_i - h_e}{h_i - h_{es}}$$

$$\text{Efficiency (compressor, pump)} = \frac{h_{es} - h_i}{h_e - h_i}$$

Throttling Valves and Throttling Processes: No work, no heat transfer, and single-mass stream. Velocity terms often insignificant.

$$h_i = h_e$$

Boilers, Condensers, Evaporators, One Side in a Heat Exchanger: Heat transfer terms are significant. For a single-mass stream, the following applies:

$$h_i + q = h_e$$

Heat Exchangers: No heat or work. Two separate flow rates \dot{m}_1 and \dot{m}_2 :

$$\dot{m}_1(h_{1i} - h_{1e}) = \dot{m}_2(h_{2e} - h_{2i})$$

Mixers, Separators, Open or Closed Feedwater Heaters:

$$\sum \dot{m}_i h_i = \sum \dot{m}_e h_e \text{ and}$$

$$\sum \dot{m}_i = \sum \dot{m}_e$$

BASIC CYCLES

Heat engines take in heat Q_H at a high temperature T_H , produce a net amount of work w , and reject heat Q_L at a low temperature T_L . The efficiency η of a heat engine is given by:

$$\eta = w/Q_H = (Q_H - Q_L)/Q_H$$

The most efficient engine possible is the *Carnot Cycle*. Its efficiency is given by:

$$\eta_c = (T_H - T_L)/T_H, \text{ where}$$

T_H and T_L = absolute temperatures (Kelvin or Rankine).

The following heat-engine cycles are plotted on P - v and T - s diagrams (see page 52):

Carnot, Otto, Rankine

Refrigeration Cycles are the reverse of heat-engine cycles. Heat is moved from low to high temperature requiring work W . Cycles can be used either for refrigeration or as heat pumps.

Coefficient of Performance (COP) is defined as:

$$\text{COP} = Q_H/W \text{ for heat pump, and as}$$

$$\text{COP} = Q_L/W \text{ for refrigerators and air conditioners.}$$

Upper limit of COP is based on reversed Carnot Cycle:

$$\text{COP}_c = T_H/(T_H - T_L) \text{ for heat pump and}$$

$$\text{COP}_c = T_L/(T_H - T_L) \text{ for refrigeration.}$$

1 ton refrigeration = 12,000 Btu/hr = 3,516 W

IDEAL GAS MIXTURES

$i = 1, 2, \dots, n$ constituents. Each constituent is an ideal gas.

Mole Fraction: N_i = number of moles of component i .

$$x_i = N_i/N; N = \sum N_i; \sum x_i = 1$$

Mass Fraction: $y_i = m_i/m; m = \sum m_i; \sum y_i = 1$

Molecular Weight: $M = m/N = \sum x_i M_i$

Gas Constant: $R = \bar{R}/M$

To convert *mole fractions to mass fractions*:

$$y_i = \frac{x_i M_i}{\sum (x_i M_i)}$$

To convert *mass fractions to mole fractions*:

$$x_i = \frac{y_i/M_i}{\sum (y_i/M_i)}$$

Partial Pressures $p = \sum p_i; p_i = \frac{m_i R_i T}{V}$

Partial Volumes $V = \sum V_i; V_i = \frac{m_i R_i T}{p}$, where

p, V, T = the pressure, volume, and temperature of the mixture.

$$x_i = p_i/p = V_i/V$$

Other Properties

$$u = \sum (y_i u_i); h = \sum (y_i h_i); s = \sum (y_i s_i)$$

u_i and h_i are evaluated at T , and

s_i is evaluated at T and p_i .

PSYCHROMETRICS

We deal here with a mixture of dry air (subscript a) and water vapor (subscript v):

$$p = p_a + p_v$$

Specific Humidity (absolute humidity) ω :

$$\omega = m_v/m_a, \text{ where}$$

m_v = mass of water vapor and

m_a = mass of dry air.

$$\omega = 0.622 p_v/p_a = 0.622 p_v/(p - p_v)$$

Relative Humidity ϕ :

$$\phi = m_v/m_g = p_v/p_g, \text{ where}$$

m_g = mass of vapor at saturation, and

p_g = saturation pressure at T .

Enthalpy h : $h = h_a + \omega h_v$

Dew-Point Temperature T_{dp} :

$$T_{dp} = T_{sat} \text{ at } p_g = p_v$$

Wet-bulb temperature T_{wb} is the temperature indicated by a thermometer covered by a wick saturated with liquid water and in contact with moving air.

Humidity Volume: Volume of moist air/mass of dry air.

Psychrometric Chart

A plot of specific humidity as a function of dry-bulb temperature plotted for a value of atmospheric pressure. (See chart at end of section.)

PHASE RELATIONS

Clapeyron Equation for Phase Transitions:

$$\left(\frac{dp}{dT} \right)_{sat} = \frac{h_{fg}}{T v_{fg}} = \frac{s_{fg}}{v_{fg}}, \text{ where}$$

h_{fg} = enthalpy change for phase transitions,

v_{fg} = volume change,

s_{fg} = entropy change,

T = absolute temperature, and

$(dp/dT)_{sat}$ = slope of vapor-liquid saturation line.

Gibbs Phase Rule

$$P + F = C + 2, \text{ where}$$

P = number of phases making up a system,

F = degrees of freedom, and

C = number of components in a system.

Gibbs Free Energy

Energy released or absorbed in a reaction occurring reversibly at constant pressure and temperature ΔG .

Helmholtz Free Energy

Energy released or absorbed in a reaction occurring reversibly at constant volume and temperature ΔA .

COMBUSTION PROCESSES

First, the combustion equation should be written and balanced. For example, for the stoichiometric combustion of methane in oxygen:

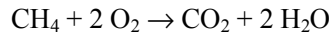
**Combustion in Air**

For each mole of oxygen, there will be 3.76 moles of nitrogen. For stoichiometric combustion of methane in air:

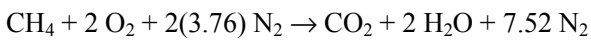
**Combustion in Excess Air**

The excess oxygen appears as oxygen on the right side of the combustion equation.

Incomplete Combustion

Some carbon is burned to create carbon monoxide (CO).

$$\text{Air-Fuel Ratio } (A/F): A/F = \frac{\text{mass of air}}{\text{mass of fuel}}$$

Stoichiometric (theoretical) air-fuel ratio is the air-fuel ratio calculated from the stoichiometric combustion equation.

$$\text{Percent Theoretical Air} = \frac{(A/F)_{\text{actual}}}{(A/F)_{\text{stoichiometric}}} \times 100$$

$$\text{Percent Excess Air} = \frac{(A/F)_{\text{actual}} - (A/F)_{\text{stoichiometric}}}{(A/F)_{\text{stoichiometric}}} \times 100$$

SECOND LAW OF THERMODYNAMICS

Thermal Energy Reservoirs

$$\Delta S_{\text{reservoir}} = Q/T_{\text{reservoir}}, \text{ where}$$

Q is measured with respect to the reservoir.

Kelvin-Planck Statement of Second Law

No heat engine can operate in a cycle while transferring heat with a single heat reservoir.

COROLLARY to Kelvin-Planck: No heat engine can have a higher efficiency than a Carnot cycle operating between the same reservoirs.

Clausius' Statement of Second Law

No refrigeration or heat pump cycle can operate without a net work input.

COROLLARY: No refrigerator or heat pump can have a higher COP than a Carnot cycle refrigerator or heat pump.

VAPOR-LIQUID MIXTURES**Henry's Law at Constant Temperature**

At equilibrium, the partial pressure of a gas is proportional to its concentration in a liquid. Henry's Law is valid for low concentrations; i.e., $x \approx 0$.

$$p_i = py_i = hx_i, \text{ where}$$

h = Henry's Law constant,

p_i = partial pressure of a gas in contact with a liquid,

x_i = mol fraction of the gas in the liquid,

y_i = mol fraction of the gas in the vapor, and

p = total pressure.

Raoult's Law for Vapor-Liquid Equilibrium

Valid for concentrations near 1; i.e., $x_i \approx 1$.

$$p_i = x_i p_i^*, \text{ where}$$

p_i = partial pressure of component i ,

x_i = mol fraction of component i in the liquid, and

p_i^* = vapor pressure of pure component i at the temperature of the mixture.

ENTROPY

$$ds = (1/T) \delta Q_{\text{rev}}$$

$$s_2 - s_1 = \int_1^2 (1/T) \delta Q_{\text{rev}}$$

Inequality of Clausius

$$\oint (1/T) \delta Q_{\text{rev}} \leq 0$$

$$\int_1^2 (1/T) \delta Q \leq s_2 - s_1$$

Isothermal, Reversible Process

$$\Delta s = s_2 - s_1 = Q/T$$

Isentropic process

$$\Delta s = 0; ds = 0$$

A reversible adiabatic process is isentropic.

Adiabatic Process

$$\delta Q = 0; \Delta s \geq 0$$

Increase of Entropy Principle

$$\Delta S_{\text{total}} = \Delta S_{\text{system}} + \Delta S_{\text{surroundings}} \geq 0$$

$$\Delta \dot{S}_{\text{total}} = \sum \dot{m}_{\text{out}} s_{\text{out}} - \sum \dot{m}_{\text{in}} s_{\text{in}} - \sum (\dot{Q}_{\text{external}}/T_{\text{external}}) \geq 0$$

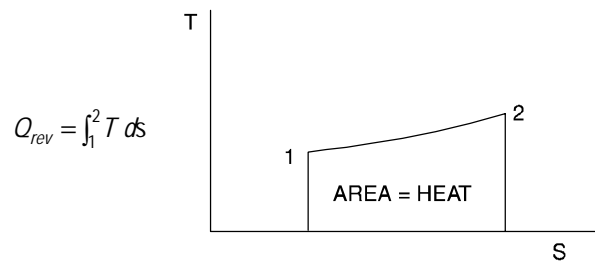
Temperature-Entropy (T - s) Diagram**Entropy Change for Solids and Liquids**

$$ds = c (dT/T)$$

$$s_2 - s_1 = \int c (dT/T) = c_{\text{mean}} \ln (T_2/T_1),$$

where c equals the heat capacity of the solid or liquid.

Irreversibility

$$I = W_{rev} - W_{\text{actual}}$$

Closed-System Availability

(no chemical reactions)

$$\phi = (u - u_o) - T_o (s - s_o) + p_o (v - v_o)$$

$$W_{\text{reversible}} = \phi_1 - \phi_2$$

Open-System Availability

$$\psi = (h - h_o) - T_o (s - s_o) + V^2/2 + gz$$

$$W_{\text{reversible}} = \psi_1 - \psi_2$$

COMMON THERMODYNAMIC CYCLES

Carnot

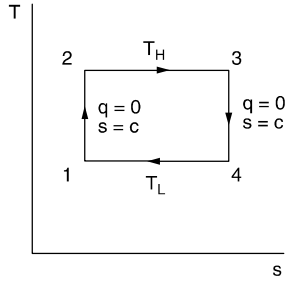
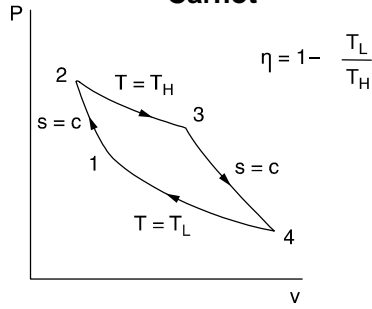

Reversed Carnot

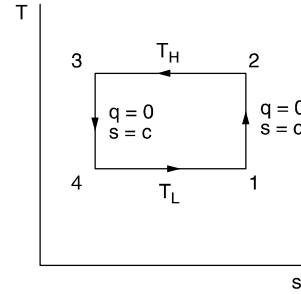

Otto

(gasoline engine)

$$\eta = 1 - r^{1-k}$$

$$r = v_1/v_2$$

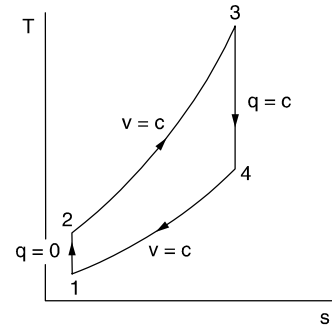
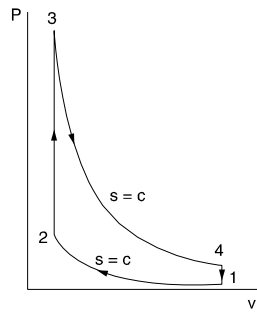

Rankine

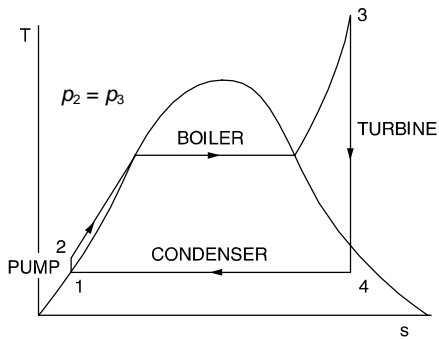
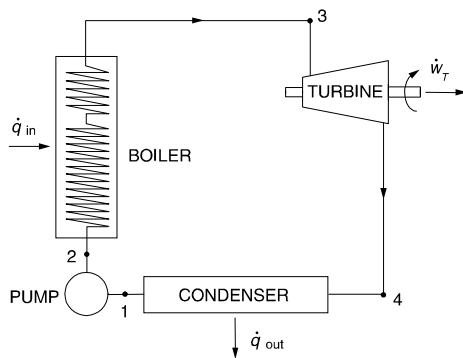

$$\eta = \frac{(h_3 - h_4) - (h_2 - h_1)}{h_3 - h_2}$$

Refrigeration

(Reversed Rankine Cycle)

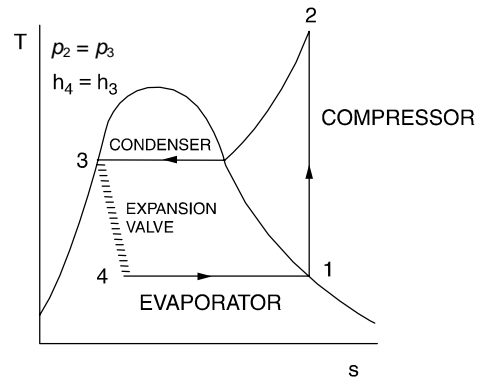
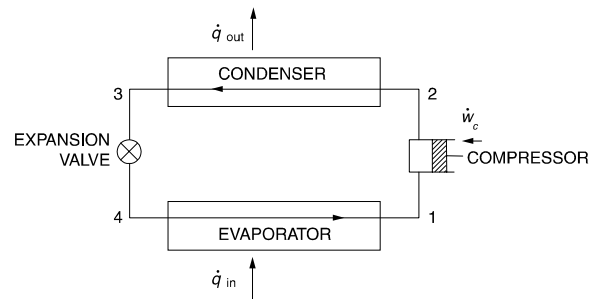

$$\text{COP}_{\text{ref}} = \frac{h_1 - h_4}{h_2 - h_1}$$

$$\text{COP}_{\text{HP}} = \frac{h_2 - h_3}{h_2 - h_1}$$

Saturated Water - Temperature Table												
Temp. °C <i>T</i>	Sat. Press. kPa <i>p_{sat}</i>	Specific Volume m ³ /kg		Internal Energy kJ/kg			Enthalpy kJ/kg			Entropy kJ/(kg·K)		
		Sat. liquid <i>v_f</i>	Sat. vapor <i>v_g</i>	Sat. liquid <i>u_f</i>	Evap. <i>u_{fg}</i>	Sat. vapor <i>u_g</i>	Sat. liquid <i>h_f</i>	Evap. <i>h_{fg}</i>	Sat. vapor <i>h_g</i>	Sat. liquid <i>s_f</i>	Evap. <i>s_{fg}</i>	Sat. vapor <i>s_g</i>
0.01	0.6113	0.001 000	206.14	0.00	2375.3	2375.3	0.01	2501.3	2501.4	0.0000	9.1562	9.1562
5	0.8721	0.001 000	147.12	20.97	2361.3	2382.3	20.98	2489.6	2510.6	0.0761	8.9496	9.0257
10	1.2276	0.001 000	106.38	42.00	2347.2	2389.2	42.01	2477.7	2519.8	0.1510	8.7498	8.9008
15	1.7051	0.001 001	77.93	62.99	2333.1	2396.1	62.99	2465.9	2528.9	0.2245	8.5569	8.7814
20	2.339	0.001 002	57.79	83.95	2319.0	2402.9	83.96	2454.1	2538.1	0.2966	8.3706	8.6672
25	3.169	0.001 003	43.36	104.88	2304.9	2409.8	104.89	2442.3	2547.2	0.3674	8.1905	8.5580
30	4.246	0.001 004	32.89	125.78	2290.8	2416.6	125.79	2430.5	2556.3	0.4369	8.0164	8.4533
35	5.628	0.001 006	25.22	146.67	2276.7	2423.4	146.68	2418.6	2565.3	0.5053	7.8478	8.3531
40	7.384	0.001 008	19.52	167.56	2262.6	2430.1	167.57	2406.7	2574.3	0.5725	7.6845	8.2570
45	9.593	0.001 010	15.26	188.44	2248.4	2436.8	188.45	2394.8	2583.2	0.6387	7.5261	8.1648
50	12.349	0.001 012	12.03	209.32	2234.2	2443.5	209.33	2382.7	2592.1	0.7038	7.3725	8.0763
55	15.758	0.001 015	9.568	230.21	2219.9	2450.1	230.23	2370.7	2600.9	0.7679	7.2234	7.9913
60	19.940	0.001 017	7.671	251.11	2205.5	2456.6	251.13	2358.5	2609.6	0.8312	7.0784	7.9096
65	25.03	0.001 020	6.197	272.02	2191.1	2463.1	272.06	2346.2	2618.3	0.8935	6.9375	7.8310
70	31.19	0.001 023	5.042	292.95	2176.6	2569.6	292.98	2333.8	2626.8	0.9549	6.8004	7.7553
75	38.58	0.001 026	4.131	313.90	2162.0	2475.9	313.93	2321.4	2635.3	1.0155	6.6669	7.6824
80	47.39	0.001 029	3.407	334.86	2147.4	2482.2	334.91	2308.8	2643.7	1.0753	6.5369	7.6122
85	57.83	0.001 033	2.828	355.84	2132.6	2488.4	355.90	2296.0	2651.9	1.1343	6.4102	7.5445
90	70.14	0.001 036	2.361	376.85	2117.7	2494.5	376.92	2283.2	2660.1	1.1925	6.2866	7.4791
95	84.55	0.001 040	1.982	397.88	2102.7	2500.6	397.96	2270.2	2668.1	1.2500	6.1659	7.4159
<i>MPa</i>												
100	0.101 35	0.001 044	1.6729	418.94	2087.6	2506.5	419.04	2257.0	2676.1	1.3069	6.0480	7.3549
105	0.120 82	0.001 048	1.4194	440.02	2072.3	2512.4	440.15	2243.7	2683.8	1.3630	5.9328	7.2958
110	0.143 27	0.001 052	1.2102	461.14	2057.0	2518.1	461.30	2230.2	2691.5	1.4185	5.8202	7.2387
115	0.169 06	0.001 056	1.0366	482.30	2041.4	2523.7	482.48	2216.5	2699.0	1.4734	5.7100	7.1833
120	0.198 53	0.001 060	0.8919	503.50	2025.8	2529.3	503.71	2202.6	2706.3	1.5276	5.6020	7.1296
125	0.2321	0.001 065	0.7706	524.74	2009.9	2534.6	524.99	2188.5	2713.5	1.5813	5.4962	7.0775
130	0.2701	0.001 070	0.6685	546.02	1993.9	2539.9	546.31	2174.2	2720.5	1.6344	5.3925	7.0269
135	0.3130	0.001 075	0.5822	567.35	1977.7	2545.0	567.69	2159.6	2727.3	1.6870	5.2907	6.9777
140	0.3613	0.001 080	0.5089	588.74	1961.3	2550.0	589.13	2144.7	2733.9	1.7391	5.1908	6.9299
145	0.4154	0.001 085	0.4463	610.18	1944.7	2554.9	610.63	2129.6	2740.3	1.7907	5.0926	6.8833
150	0.4758	0.001 091	0.3928	631.68	1927.9	2559.5	632.20	2114.3	2746.5	1.8418	4.9960	6.8379
155	0.5431	0.001 096	0.3468	653.24	1910.8	2564.1	653.84	2098.6	2752.4	1.8925	4.9010	6.7935
160	0.6178	0.001 102	0.3071	674.87	1893.5	2568.4	675.55	2082.6	2758.1	1.9427	4.8075	6.7502
165	0.7005	0.001 108	0.2727	696.56	1876.0	2572.5	697.34	2066.2	2763.5	1.9925	4.7153	6.7078
170	0.7917	0.001 114	0.2428	718.33	1858.1	2576.5	719.21	2049.5	2768.7	2.0419	4.6244	6.6663
175	0.8920	0.001 121	0.2168	740.17	1840.0	2580.2	741.17	2032.4	2773.6	2.0909	4.5347	6.6256
180	1.0021	0.001 127	0.194 05	762.09	1821.6	2583.7	763.22	2015.0	2778.2	2.1396	4.4461	6.5857
185	1.1227	0.001 134	0.174 09	784.10	1802.9	2587.0	785.37	1997.1	2782.4	2.1879	4.3586	6.5465
190	1.2544	0.001 141	0.156 54	806.19	1783.8	2590.0	807.62	1978.8	2786.4	2.2359	4.2720	6.5079
195	1.3978	0.001 149	0.141 05	828.37	1764.4	2592.8	829.98	1960.0	2790.0	2.2835	4.1863	6.4698
200	1.5538	0.001 157	0.127 36	850.65	1744.7	2595.3	852.45	1940.7	2793.2	2.3309	4.1014	6.4323
205	1.7230	0.001 164	0.115 21	873.04	1724.5	2597.5	875.04	1921.0	2796.0	2.3780	4.0172	6.3952
210	1.9062	0.001 173	0.104 41	895.53	1703.9	2599.5	897.76	1900.7	2798.5	2.4248	3.9337	6.3585
215	2.104	0.001 181	0.094 79	918.14	1682.9	2601.1	920.62	1879.9	2800.5	2.4714	3.8507	6.3221
220	2.318	0.001 190	0.086 19	940.87	1661.5	2602.4	943.62	1858.5	2802.1	2.5178	3.7683	6.2861
225	2.548	0.001 199	0.078 49	963.73	1639.6	2603.3	966.78	1836.5	2803.3	2.5639	3.6863	6.2503
230	2.795	0.001 209	0.071 58	986.74	1617.2	2603.9	990.12	1813.8	2804.0	2.6099	3.6047	6.2146
235	3.060	0.001 219	0.065 37	1009.89	1594.2	2604.1	1013.62	1790.5	2804.2	2.6558	3.5233	6.1791
240	3.344	0.001 229	0.059 76	1033.21	1570.8	2604.0	1037.32	1766.5	2803.8	2.7015	3.4422	6.1437
245	3.648	0.001 240	0.054 71	1056.71	1546.7	2603.4	1061.23	1741.7	2803.0	2.7472	3.3612	6.1083
250	3.973	0.001 251	0.050 13	1080.39	1522.0	2602.4	1085.36	1716.2	2801.5	2.7927	3.2802	6.0730
255	4.319	0.001 263	0.045 98	1104.28	1506.7	2600.9	1109.73	1689.8	2799.5	2.8383	3.1992	6.0375
260	4.688	0.001 276	0.042 21	1128.39	1470.6	2599.0	1134.37	1662.5	2796.9	2.8838	3.1181	6.0019
265	5.081	0.001 289	0.038 77	1152.74	1443.9	2596.6	1159.28	1634.4	2793.6	2.9294	3.0368	5.9662
270	5.499	0.001 302	0.035 64	1177.36	1416.3	2593.7	1184.51	1605.2	2789.7	2.9751	2.9551	5.9301
275	5.942	0.001 317	0.032 79	1202.25	1387.9	2590.2	1210.07	1574.9	2785.0	3.0208	2.8730	5.8938
280	6.412	0.001 332	0.030 17	1227.46	1358.7	2586.1	1235.99	1543.6	2779.6	3.0668	2.7903	5.8571
285	6.909	0.001 348	0.027 77	1253.00	1328.4	2581.4	1262.31	1511.0	2773.3	3.1130	2.7070	5.8199
290	7.436	0.001 366	0.025 57	1278.92	1297.1	2576.0	1289.07	1477.1	2766.2	3.1594	2.6227	5.7821
295	7.993	0.001 384	0.023 54	1305.2	1264.7	2569.9	1316.3	1441.8	2758.1	3.2062	2.5375	5.7437
300	8.581	0.001 404	0.021 67	1332.0	1231.0	2563.0	1344.0	1404.9	2749.0	3.2534	2.4511	5.7045
305	9.202	0.001 425	0.019 948	1359.3	1195.9	2555.2	1372.4	1366.4	2738.7	3.3010	2.3633	5.6643
310	9.856	0.001 447	0.018 350	1387.1	1159.4	2546.4	1401.3	1326.0	2727.3	3.3493	2.2737	5.6230
315	10.547	0.001 472	0.016 867	1415.5	1121.1	2536.6	1431.0	1283.5	2714.5	3.3982	2.1821	5.5804
320	11.274	0.001 499	0.015 488	1444.6	1080.9	2525.5	1461.5	1238.6	2700.1	3.4480	2.0882	5.5362
330	12.845	0.001 561	0.012 996	1505.3	993.7	2498.9	1525.3	1140.6	2665.9	3.5507	1.8909	5.4417
340	14.586	0.001 638	0.010 797	1570.3	894.3	2464.6	1594.2	1027.9	2622.0	3.6594	1.6763	5.3357
350	16.513	0.001 740	0.008 813	1641.9	776.6	2418.4	1670.6	893.4	2563.9	3.7777	1.4335	5.2112
360	18.651	0.001 893	0.006 945	1725.2	626.3	2351.5	1760.5	720.3	2481.0	3.9147	1.1379	5.0526
370	21.03	0.002 213	0.004 925	1844.0	384.5	2228.5	1890.5	441.6	2332.1	4.1106	0.6865	4.7971
374.14	22.09	0.003 155	0.003 155	2029.6	0	2029.6	2099.3	0	2099.3	4.4298	0	4.4298

Superheated Water Tables								
T Temp. °C	v m ³ /kg	u kJ/kg	h kJ/kg	s kJ/(kg·K)	v m ³ /kg	u kJ/kg	h kJ/kg	s kJ/(kg·K)
	$p = 0.01 \text{ MPa (45.81}^\circ\text{C)}$				$p = 0.05 \text{ MPa (81.33}^\circ\text{C)}$			
Sat.	14.674	2437.9	2584.7	8.1502	3.240	2483.9	2645.9	7.5939
50	14.869	2443.9	2592.6	8.1749				
100	17.196	2515.5	2687.5	8.4479	3.418	2511.6	2682.5	7.6947
150	19.512	2587.9	2783.0	8.6882	3.889	2585.6	2780.1	7.9401
200	21.825	2661.3	2879.5	8.9038	4.356	2659.9	2877.7	8.1580
250	24.136	2736.0	2977.3	9.1002	4.820	2735.0	2976.0	8.3556
300	26.445	2812.1	3076.5	9.2813	5.284	2811.3	3075.5	8.5373
400	31.063	2968.9	3279.6	9.6077	6.209	2968.5	3278.9	8.8642
500	35.679	3132.3	3489.1	9.8978	7.134	3132.0	3488.7	9.1546
600	40.295	3302.5	3705.4	10.1608	8.057	3302.2	3705.1	9.4178
700	44.911	3479.6	3928.7	10.4028	8.981	3479.4	3928.5	9.6599
800	49.526	3663.8	4159.0	10.6281	9.904	3663.6	4158.9	9.8852
900	54.141	3855.0	4396.4	10.8396	10.828	3854.9	4396.3	10.0967
1000	58.757	4053.0	4640.6	11.0393	11.751	4052.9	4640.5	10.2964
1100	63.372	4257.5	4891.2	11.2287	12.674	4257.4	4891.1	10.4859
1200	67.987	4467.9	5147.8	11.4091	13.597	4467.8	5147.7	10.6662
1300	72.602	4683.7	5409.7	11.5811	14.521	4683.6	5409.6	10.8382
	$p = 0.10 \text{ MPa (99.63}^\circ\text{C)}$				$p = 0.20 \text{ MPa (120.23}^\circ\text{C)}$			
Sat.	1.6940	2506.1	2675.5	7.3594	0.8857	2529.5	2706.7	7.1272
100	1.6958	2506.7	2676.2	7.3614				
150	1.9364	2582.8	2776.4	7.6134	0.9596	2576.9	2768.8	7.2795
200	2.172	2658.1	2875.3	7.8343	1.0803	2654.4	2870.5	7.5066
250	2.406	2733.7	2974.3	8.0333	1.1988	2731.2	2971.0	7.7086
300	2.639	2810.4	3074.3	8.2158	1.3162	2808.6	3071.8	7.8926
400	3.103	2967.9	3278.2	8.5435	1.5493	2966.7	3276.6	8.2218
500	3.565	3131.6	3488.1	8.8342	1.7814	3130.8	3487.1	8.5133
600	4.028	3301.9	3704.4	9.0976	2.013	3301.4	3704.0	8.7770
700	4.490	3479.2	3928.2	9.3398	2.244	3478.8	3927.6	9.0194
800	4.952	3663.5	4158.6	9.5652	2.475	3663.1	4158.2	9.2449
900	5.414	3854.8	4396.1	9.7767	2.705	3854.5	4395.8	9.4566
1000	5.875	4052.8	4640.3	9.9764	2.937	4052.5	4640.0	9.6563
1100	6.337	4257.3	4891.0	10.1659	3.168	4257.0	4890.7	9.8458
1200	6.799	4467.7	5147.6	10.3463	3.399	4467.5	5147.5	10.0262
1300	7.260	4683.5	5409.5	10.5183	3.630	4683.2	5409.3	10.1982
	$p = 0.40 \text{ MPa (143.63}^\circ\text{C)}$				$p = 0.60 \text{ MPa (158.85}^\circ\text{C)}$			
Sat.	0.4625	2553.6	2738.6	6.8959	0.3157	2567.4	2756.8	6.7600
150	0.4708	2564.5	2752.8	6.9299				
200	0.5342	2646.8	2860.5	7.1706	0.3520	2638.9	2850.1	6.9665
250	0.5951	2726.1	2964.2	7.3789	0.3938	2720.9	2957.2	7.1816
300	0.6548	2804.8	3066.8	7.5662	0.4344	2801.0	3061.6	7.3724
350					0.4742	2881.2	3165.7	7.5464
400	0.7726	2964.4	3273.4	7.8985	0.5137	2962.1	3270.3	7.7079
500	0.8893	3129.2	3484.9	8.1913	0.5920	3127.6	3482.8	8.0021
600	1.0055	3300.2	3702.4	8.4558	0.6697	3299.1	3700.9	8.2674
700	1.1215	3477.9	3926.5	8.6987	0.7472	3477.0	3925.3	8.5107
800	1.2372	3662.4	4157.3	8.9244	0.8245	3661.8	4156.5	8.7367
900	1.3529	3853.9	4395.1	9.1362	0.9017	3853.4	4394.4	8.9486
1000	1.4685	4052.0	4639.4	9.3360	0.9788	4051.5	4638.8	9.1485
1100	1.5840	4256.5	4890.2	9.5256	1.0559	4256.1	4889.6	9.3381
1200	1.6996	4467.0	5146.8	9.7060	1.1330	4466.5	5146.3	9.5185
1300	1.8151	4682.8	5408.8	9.8780	1.2101	4682.3	5408.3	9.6906
	$p = 0.80 \text{ MPa (170.43}^\circ\text{C)}$				$p = 1.00 \text{ MPa (179.91}^\circ\text{C)}$			
Sat.	0.2404	2576.8	2769.1	6.6628	0.19444	2583.6	2778.1	6.5865
200	0.2608	2630.6	2839.3	6.8158	0.2060	2621.9	2827.9	6.6940
250	0.2931	2715.5	2950.0	7.0384	0.2327	2709.9	2942.6	6.9247
300	0.3241	2797.2	3056.5	7.2328	0.2579	2793.2	3051.2	7.1229
350	0.3544	2878.2	3161.7	7.4089	0.2825	2875.2	3157.7	7.3011
400	0.3843	2959.7	3267.1	7.5716	0.3066	2957.3	3263.9	7.4651
500	0.4433	3126.0	3480.6	7.8673	0.3541	3124.4	3478.5	7.7622
600	0.5018	3297.9	3699.4	8.1333	0.4011	3296.8	3697.9	8.0290
700	0.5601	3476.2	3924.2	8.3770	0.4478	3475.3	3923.1	8.2731
800	0.6181	3661.1	4155.6	8.6033	0.4943	3660.4	4154.7	8.4996
900	0.6761	3852.8	4393.7	8.8153	0.5407	3852.2	4392.9	8.7118
1000	0.7340	4051.0	4638.2	9.0153	0.5871	4050.5	4637.6	8.9119
1100	0.7919	4255.6	4889.1	9.2050	0.6335	4255.1	4888.6	9.1017
1200	0.8497	4466.1	5145.9	9.3855	0.6798	4465.6	5145.4	9.2822
1300	0.9076	4681.8	5407.9	9.5575	0.7261	4681.3	5407.4	9.4543

P-h DIAGRAM FOR REFRIGERANT HFC-134a

(metric units)

(Reproduced by permission of the DuPont Company)

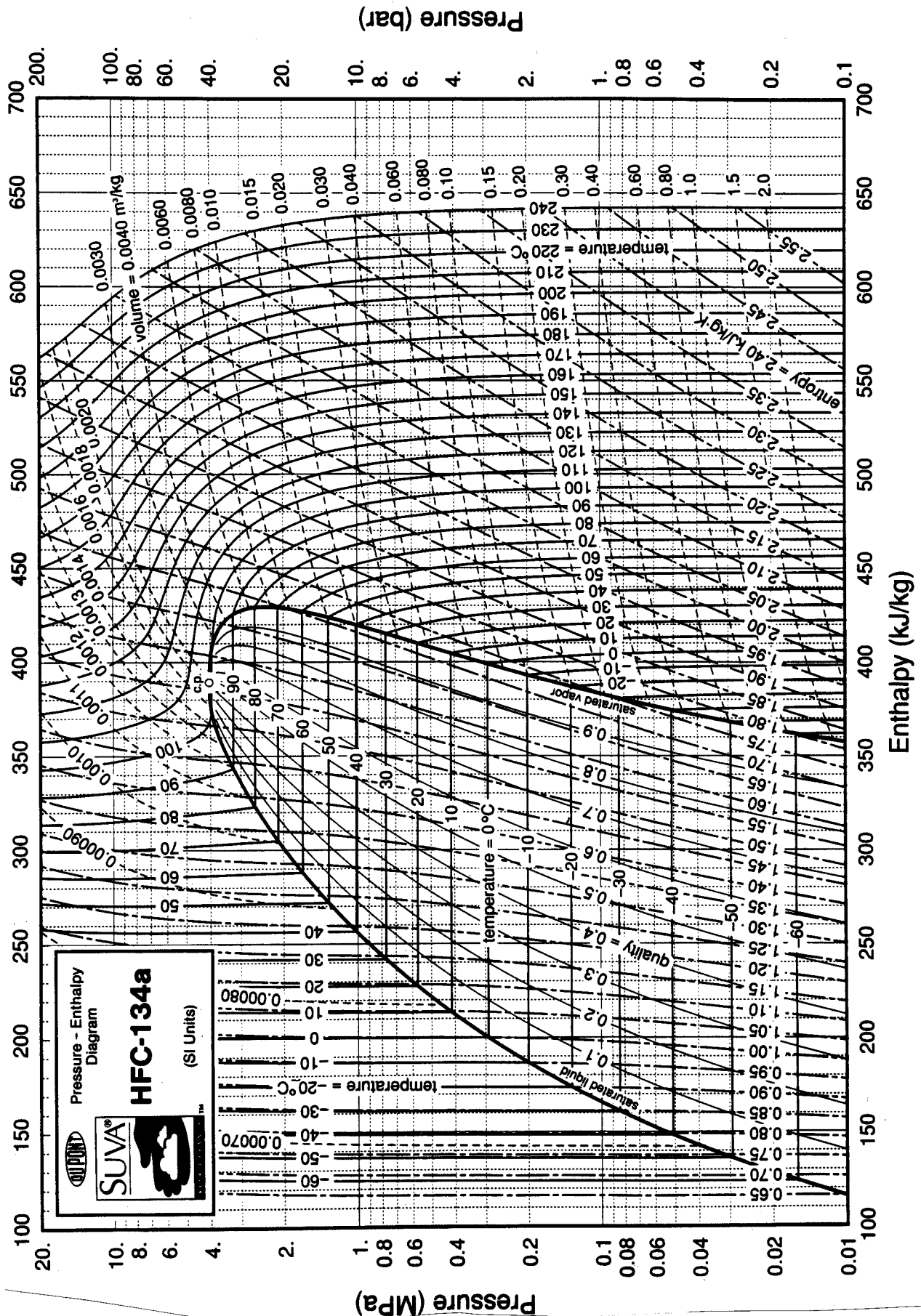

ASHRAE PSYCHROMETRIC CHART NO. 1

(metric units)

Reproduced by permission of ASHRAE



ASHRAE PSYCHROMETRIC CHART NO. 1
 NORMAL TEMPERATURE SEA LEVEL
 BAROMETRIC PRESSURE 101.325 kPa.

COPYRIGHT 1982
 AMERICAN SOCIETY OF HEATING, REFRIGERATING AND AIR-CONDITIONING ENGINEERS, INC.

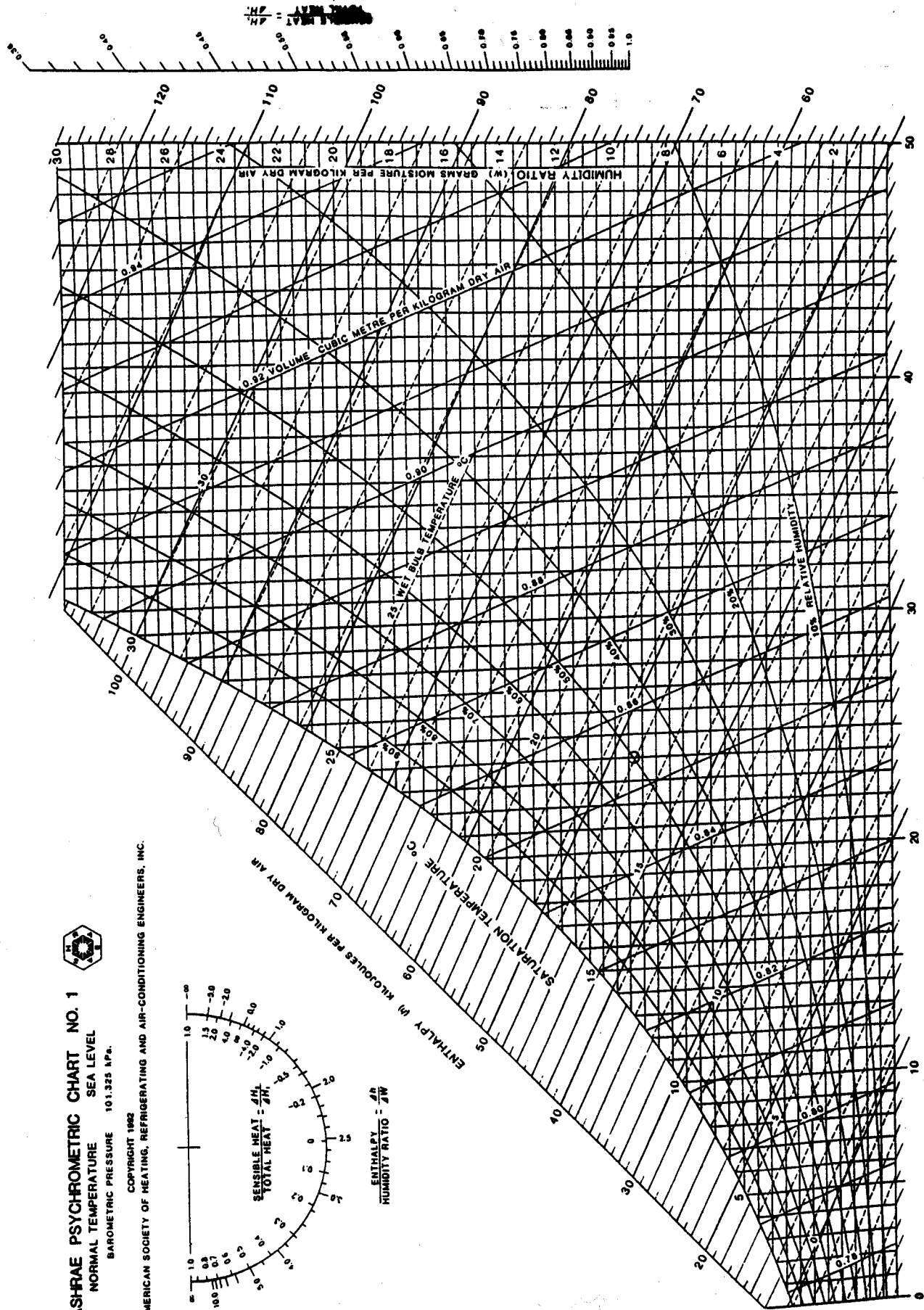
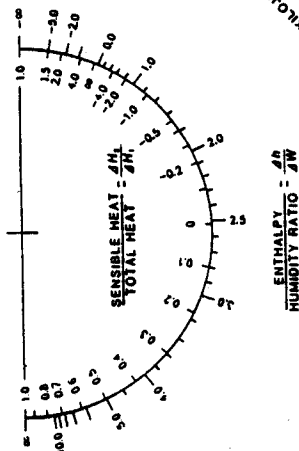

Prepared by: CENTER FOR APPLIED THERMODYNAMIC STUDIES, UNIVERSITY OF MANITOBA

HEAT CAPACITY
(at Room Temperature)

Substance	Mol wt	c_p		c_v		k
		kJ/(kg·K)	Btu/(lbm-°R)	kJ/(kg·K)	Btu/(lbm-°R)	
Gases						
Air	29	1.00	0.240	0.718	0.171	1.40
Argon	40	0.520	0.125	0.312	0.0756	1.67
Butane	58	1.72	0.415	1.57	0.381	1.09
Carbon dioxide	44	0.846	0.203	0.657	0.158	1.29
Carbon monoxide	28	1.04	0.249	0.744	0.178	1.40
Ethane	30	1.77	0.427	1.49	0.361	1.18
Helium	4	5.19	1.25	3.12	0.753	1.67
Hydrogen	2	14.3	3.43	10.2	2.44	1.40
Methane	16	2.25	0.532	1.74	0.403	1.30
Neon	20	1.03	0.246	0.618	0.148	1.67
Nitrogen	28	1.04	0.248	0.743	0.177	1.40
Octane vapor	114	1.71	0.409	1.64	0.392	1.04
Oxygen	32	0.918	0.219	0.658	0.157	1.40
Propane	44	1.68	0.407	1.49	0.362	1.12
Steam	18	1.87	0.445	1.41	0.335	1.33

Substance	c_p		Density	
	kJ/(kg·K)	Btu/(lbm-°R)	kg/m ³	lbm/ft ³
Liquids				
Ammonia	4.80	1.146	602	38
Mercury	0.139	0.033	13,560	847
Water	4.18	1.000	997	62.4
Solids				
Aluminum	0.900	0.215	2,700	170
Copper	0.386	0.092	8,900	555
Ice (0°C; 32°F)	2.11	0.502	917	57.2
Iron	0.450	0.107	7,840	490
Lead	0.128	0.030	11,310	705

HEAT TRANSFER

There are three modes of heat transfer: conduction, convection, and radiation. Boiling and condensation are classified as convection.

Conduction

Fourier's Law of Conduction

$$\dot{Q} = -kA(dT/dx), \text{ where}$$

\dot{Q} = rate of heat transfer.

Conduction Through a Plane Wall:

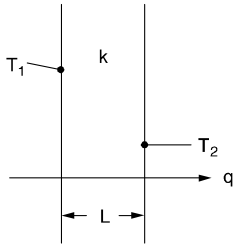

$$\dot{Q} = -kA(T_2 - T_1)/L, \text{ where}$$

k = the thermal conductivity of the wall,

A = the wall surface area,

L = the wall thickness, and

T_1, T_2 = the temperature on the near side and far side of the wall respectively.

Thermal resistance of the wall is given by

$$R = L/(kA)$$

Resistances in series are added.

Composite Walls:

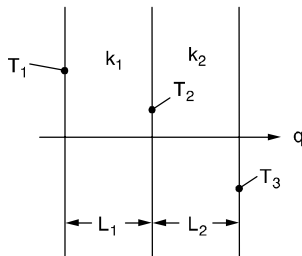

$$R_{\text{total}} = R_1 + R_2, \text{ where}$$

$$R_1 = L_1/(k_1A), \text{ and}$$

$$R_2 = L_2/(k_2A).$$

To Evaluate Surface or Intermediate Temperatures:

$$T_2 = T_1 - \dot{Q}R_1; T_3 = T_2 - \dot{Q}R_2$$

Conduction through a cylindrical wall is given by

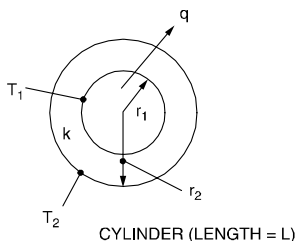

$$\dot{Q} = \frac{2\pi kL(T_1 - T_2)}{\ln(r_2/r_1)}$$

$$R = \frac{\ln(r_2/r_1)}{2\pi kL}$$

Convection

Convection is determined using a convection coefficient (heat transfer coefficient) h .

$$\dot{Q} = hA(T_w - T_\infty), \text{ where}$$

A = the heat transfer area,

T_w = work temperature, and

T_∞ = bulk fluid temperature.

Resistance due to convection is given by

$$R = 1/(hA)$$

FINS: For a straight fin,

$$\dot{Q} = \sqrt{hpka_c}(T_b - T_\infty) \tanh mL_c, \text{ where}$$

h = heat transfer coefficient,

p = exposed perimeter,

k = thermal conductivity,

A_c = cross-sectional area,

T_b = temperature at base of fin,

T_∞ = fluid temperature,

$m = \sqrt{hp/(kA_c)}$, and

$L_c = L + A_c/p$, corrected length.

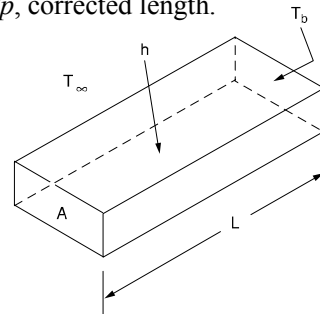

Radiation

The radiation emitted by a body is given by

$$\dot{Q} = \epsilon\sigma AT^4, \text{ where}$$

T = the absolute temperature (K or °R),

$$\sigma = 5.67 \times 10^{-8} \text{ W}/(\text{m}^2 \cdot \text{K}^4)$$

$$[0.173 \times 10^{-8} \text{ Btu}/(\text{hr} \cdot \text{ft}^2 \cdot \text{R}^4)],$$

ϵ = the emissivity of the body, and

A = the body surface area.

For a body (1) which is small compared to its surroundings (2)

$$\dot{Q}_{12} = \epsilon\sigma A(T_1^4 - T_2^4), \text{ where}$$

\dot{Q}_{12} = the net heat transfer rate from the body.

A *black body* is defined as one which absorbs all energy incident upon it. It also emits radiation at the maximum rate for a body of a particular size at a particular temperature. For such a body

$$\alpha = \varepsilon = 1, \text{ where}$$

α = the absorptivity (energy absorbed/incident energy).

A *gray body* is one for which $\alpha = \varepsilon$, where

$$0 < \alpha < 1; 0 < \varepsilon < 1$$

Real bodies are frequently approximated as gray bodies.

The net energy exchange by radiation between two black bodies, which see each other, is given by

$$\dot{Q}_{12} = A_1 F_{12} \sigma (T_1^4 - T_2^4), \text{ where}$$

F_{12} = the shape factor (view factor, configuration factor); $0 \leq F_{12} \leq 1$.

For any body, $\alpha + \rho + \tau = 1$, where

α = absorptivity,

ρ = reflectivity (ratio of energy reflected to incident energy), and

τ = transmissivity (ratio of energy transmitted to incident energy).

For an opaque body, $\alpha + \rho = 1$

For a gray body, $\varepsilon + \rho = 1$

The following is applicable to the PM examination for mechanical and chemical engineers.

The overall *heat-transfer coefficient* for a shell-and-tube heat exchanger is

$$\frac{1}{UA} = \frac{1}{h_i A_i} + \frac{R_{fi}}{A_i} + \frac{t}{k A_{avg}} + \frac{R_{fo}}{A_o} + \frac{1}{h_o A_o}, \text{ where}$$

A = any convenient reference area (m^2),

A_{avg} = average of inside and outside area (for thin-walled tubes) (m^2),

A_i = inside area of tubes (m^2),

A_o = outside area of tubes (m^2),

h_i = *heat-transfer coefficient* for inside of tubes [$W/(m^2 \cdot K)$],

h_o = *heat-transfer coefficient* for outside of tubes [$W/(m^2 \cdot K)$],

k = *thermal conductivity* of tube material [$W/(m \cdot K)$],

R_{fi} = *fouling factor* for inside of tube ($m^2 \cdot K/W$),

R_{fo} = *fouling factor* for outside of tube ($m^2 \cdot K/W$),

t = tube-wall thickness (m), and

U = *overall heat-transfer coefficient* based on area A and the log mean temperature difference [$W/(m^2 \cdot K)$].

The *log mean temperature difference* (LMTD) for *countercurrent flow* in tubular heat exchangers is

$$\Delta T_{lm} = \frac{(T_{Ho} - T_{Ci}) - (T_{Hi} - T_{Co})}{\ln \left(\frac{T_{Ho} - T_{Ci}}{T_{Hi} - T_{Co}} \right)}$$

The *log mean temperature difference* for *concurrent* (parallel) *flow* in tubular heat exchangers is

$$\Delta T_{lm} = \frac{(T_{Ho} - T_{Co}) - (T_{Hi} - T_{Ci})}{\ln \left(\frac{T_{Ho} - T_{Co}}{T_{Hi} - T_{Ci}} \right)}, \text{ where}$$

ΔT_{lm} = log mean temperature difference (K),

T_{Hi} = inlet temperature of the hot fluid (K),

T_{Ho} = outlet temperature of the hot fluid (K),

T_{Ci} = inlet temperature of the cold fluid (K), and

T_{Co} = outlet temperature of the cold fluid (K).

For individual heat-transfer coefficients of a fluid being heated or cooled in a tube, one pair of temperatures (either the hot or the cold) are the surface temperatures at the inlet and outlet of the tube.

Heat exchanger effectiveness =

$$\frac{\text{actual heat transfer}}{\text{max possible heat transfer}} = \frac{q}{q_{\max}}$$

$$\varepsilon = \frac{C_H (T_{Hi} - T_{Ho})}{C_{\min} (T_{Hi} - T_{Ci})}$$

or

$$\varepsilon = \frac{C_C (T_{Co} - T_{Ci})}{C_{\min} (T_{Hi} - T_{Ci})}$$

Where C_{\min} = smaller of C_c or C_H and $C = \dot{m}c_p$

$$\text{Number of transfer units, NTU} = \frac{UA}{C_{\min}}$$

At a cross-section in a tube where heat is being transferred

$$\frac{\dot{Q}}{A} = h(T_w - T_b) = \left[k_f \left(\frac{dt}{dr} \right)_w \right]_{\text{fluid}}$$

$$= \left[k_m \left(\frac{dt}{dr} \right)_w \right]_{\text{metal}}, \text{ where}$$

\dot{Q}/A = local inward radial heat flux (W/m^2),

h = local heat-transfer coefficient [$W/(m^2 \cdot K)$],

k_f = thermal conductivity of the fluid [$W/(m \cdot K)$],

k_m = thermal conductivity of the tube metal [$W/(m \cdot K)$],

$(dt/dr)_w$ = radial temperature gradient at the tube surface (K/m),

T_b = local bulk temperature of the fluid (K), and

T_w = local inside surface temperature of the tube (K).

Rate of Heat Transfer in a Tubular Heat Exchanger

For the equations below, the following definitions along with definitions previously supplied are required.

D = inside diameter

Gz = Graetz number $[RePr (D/L)]$,

Nu = Nusselt number (hD/k) ,

Pr = Prandtl number $(c_p\mu/k)$,

A = area upon which U is based (m^2),

F = configuration correction factor,

g = acceleration of gravity (9.81 m/s^2),

L = heated (or cooled) length of conduit or surface (m),

\dot{Q} = inward rate of heat transfer (W),

T_s = temperature of the surface (K),

T_{sv} = temperature of saturated vapor (K), and

λ = heat of vaporization (J/kg).

$$\dot{Q} = UAF\Delta T_{lm}$$

Heat-transfer for laminar flow ($Re < 2,000$) in a closed conduit.

$$Nu = 3.66 + \frac{0.19Gz^{0.8}}{1 + 0.117Gz^{0.467}}$$

Heat-transfer for turbulent flow ($Re > 10^4$, $Pr > 0.7$) in a closed conduit (Sieder-Tate equation).

$$Nu = \frac{h_i D}{k_f} = 0.023Re^{0.8}Pr^{1/3}(\mu_b/\mu_w)^{0.14}, \text{ where}$$

$\mu_b = \mu(T_b)$, and

$\mu_w = \mu(T_w)$, and Re and Pr are evaluated at T_b .

For non-circular ducts, use the equivalent diameter.

The equivalent diameter is defined as

$$D_H = \frac{4(\text{cross-sectional area})}{\text{wetted perimeter}}$$

For a circular annulus ($D_o > D_i$) the equivalent diameter is

$$D_H = D_o - D_i$$

For liquid metals ($0.003 < Pr < 0.05$) flowing in closed conduits.

$Nu = 6.3 + 0.0167Re^{0.85}Pr^{0.93}$ (constant heat flux)

$Nu = 7.0 + 0.025Re^{0.8}Pr^{0.8}$ (constant wall temperature)

Heat-transfer coefficient for condensation of a pure vapor on a vertical surface.

$$\frac{hL}{k} = 0.943 \left(\frac{L^3 \rho^2 g \lambda}{k \mu (T_{sv} - T_s)} \right)^{0.25}$$

Properties other than λ are for the liquid and are evaluated at the average between T_{sv} and T_s .

For condensation outside horizontal tubes, change 0.943 to 0.73 and replace L with the tube outside diameter.

Heat Transfer to/from Bodies Immersed in a Large Body of Flowing Fluid

In all cases, evaluate fluid properties at average temperature between that of the body and that of the flowing fluid.

For flow parallel to a constant-temperature flat plate of length L (m)

$$Nu = 0.648Re^{0.5}Pr^{1/3} \quad (Re < 10^5)$$

$$Nu = 0.0366Re^{0.8}Pr^{1/3} \quad (Re > 10^5)$$

Use the plate length in the evaluation of the Nusselt and Reynolds numbers.

For flow perpendicular to the axis of a constant-temperature circular cylinder

$$Nu = cRe^n Pr^{1/3} \quad (\text{values of } c \text{ and } n \text{ follow})$$

Use the cylinder diameter in the evaluation of the Nusselt and Reynolds numbers.

Re	n	c
1 – 4	0.330	0.989
4 – 40	0.385	0.911
40 – 4,000	0.466	0.683
4,000 – 40,000	0.618	0.193
40,000 – 250,000	0.805	0.0266

For flow past a constant-temperature sphere. $Nu = 2.0 + 0.60Re^{0.5}Pr^{1/3}$

($1 < Re < 70,000$, $0.6 < Pr < 400$)

Use the sphere diameter in the evaluation of the Nusselt and Reynolds numbers.

Conductive Heat Transfer*Steady Conduction with Internal Energy Generation*

For one-dimensional steady conduction, the equation is

$$d^2T/dx^2 + \dot{Q}_{gen}/k = 0, \text{ where}$$

\dot{Q}_{gen} = the heat generation rate per unit volume, and

k = the thermal conductivity.

For a plane wall:

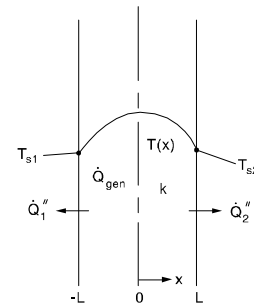

$$T(x) = \frac{\dot{Q}_{gen} L^2}{2k} \left(1 - \frac{x^2}{L^2} \right) + \left(\frac{T_{s2} - T_{s1}}{2} \right) \left(\frac{x}{L} \right) + \left(\frac{T_{s1} + T_{s2}}{2} \right)$$

$$\dot{Q}_1'' + \dot{Q}_2'' = 2\dot{Q}_{gen}L, \text{ where}$$

$$\dot{Q}_1'' = k(dT/dx)_{-L}$$

$$\dot{Q}_2'' = -k(dT/dx)_L$$

For a long circular cylinder:

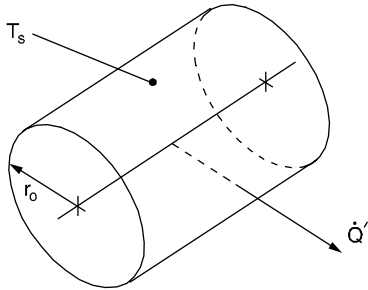

$$\frac{1}{r} \frac{d}{dr} \left(r \frac{dT}{dr} \right) + \frac{\dot{Q}_{\text{gen}}}{k} = 0$$

$$T(r) = \frac{\dot{Q}_{\text{gen}} r_0^2}{4k} \left(1 - \frac{r^2}{r_0^2} \right) + T_s$$

$$\dot{Q}' = \pi r_0^2 \dot{Q}_{\text{gen}}, \text{ where}$$

\dot{Q}' = the heat-transfer rate from the cylinder per unit length.

Transient Conduction Using the Lumped Capacitance Method

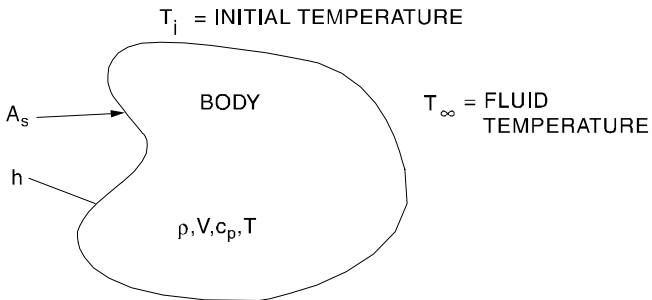

If the temperature may be considered uniform within the body at any time, the change of body temperature is given by

$$\dot{Q} = hA_s(T - T_\infty) = -\rho c_p V (dT/dt)$$

The temperature variation with time is

$$T - T_\infty = (T_i - T_\infty) e^{-(hA_s / \rho c_p V)t}$$

The total heat transferred up to time t is

$$Q_{\text{total}} = \rho c_p V (T_i - T), \text{ where}$$

ρ = density,

V = volume,

c_p = heat capacity,

t = time,

A_s = surface area of the body,

T = temperature, and

h = the heat-transfer coefficient.

The lumped capacitance method is valid if

$$\text{Biot number} = \text{Bi} = hV/kA_s \ll 1$$

Natural (Free) Convection

For free convection between a vertical flat plate (or a vertical cylinder of sufficiently large diameter) and a large body of stationary fluid,

$$h = C(k/L) \text{Ra}_L^n, \text{ where}$$

L = the length of the plate in the vertical direction,

$$\text{Ra}_L = \text{Rayleigh Number} = \frac{g\beta(T_s - T_\infty)L^3}{\nu^2} \text{Pr},$$

T_s = surface temperature,

T_∞ = fluid temperature,

β = coefficient of thermal expansion ($\frac{2}{T_s + T_\infty}$ for an

ideal gas where T is absolute temperature), and

ν = kinematic viscosity.

Range of Ra_L	C	n
$10^4 - 10^9$	0.59	1/4
$10^9 - 10^{13}$	0.10	1/3

For free convection between a long horizontal cylinder and a large body of stationary fluid

$$h = C(k/D) \text{Ra}_D^n, \text{ where}$$

$$\text{Ra}_D = \frac{g\beta(T_s - T_\infty)D^3}{\nu^2} \text{Pr}$$

Range of Ra_D	C	n
$10^{-3} - 10^2$	1.02	0.148
$10^2 - 10^4$	0.850	0.188
$10^4 - 10^7$	0.480	0.250
$10^7 - 10^{12}$	0.125	0.333

Radiation

Two-Body Problem

Applicable to any two diffuse-gray surfaces that form an enclosure.

$$\dot{Q}_{12} = \frac{\sigma(T_1^4 - T_2^4)}{\frac{1 - \epsilon_1}{\epsilon_1 A_1} + \frac{1}{A_1 F_{12}} + \frac{1 - \epsilon_2}{\epsilon_2 A_2}}$$

Generalized Cases

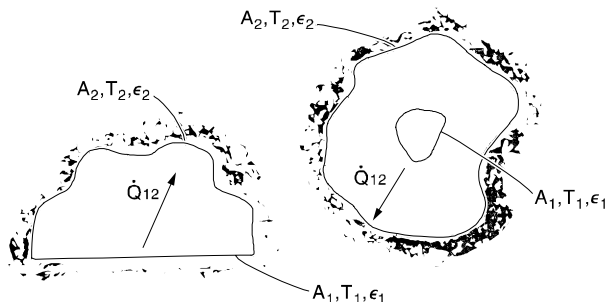

Radiation Shields

One-dimensional geometry with low-emissivity shield inserted between two parallel plates.

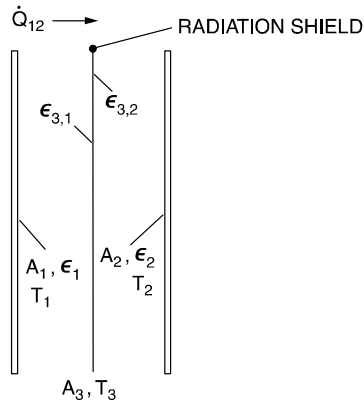

$$\dot{Q}_{12} = \frac{\sigma(T_1^4 - T_2^4)}{\frac{1-\epsilon_1}{\epsilon_1 A_1} + \frac{1}{A_1 F_{13}} + \frac{1-\epsilon_{3,1}}{\epsilon_{3,1} A_3} + \frac{1-\epsilon_{3,2}}{\epsilon_{3,2} A_3} + \frac{1}{A_3 F_{32}} + \frac{1-\epsilon_2}{\epsilon_2 A_2}}$$

Shape Factor Relations

Reciprocity relations:

$$A_i F_{ij} = A_j F_{ji}$$

Summation rule:

$$\sum_{j=1}^N F_{ij} = 1$$

Reradiating Surface

Reradiating surfaces are considered to be insulated, or adiabatic ($\dot{Q}_R = 0$).

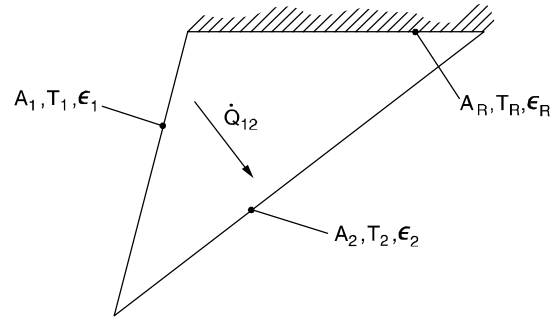

$$\dot{Q}_{12} = \frac{\sigma(T_1^4 - T_2^4)}{\frac{1-\epsilon_1}{\epsilon_1 A_1} + \frac{1}{A_1 F_{12} + \left[\left(\frac{1}{A_1 F_{1R}} \right) + \left(\frac{1}{A_2 F_{2R}} \right) \right]^{-1} + \frac{1-\epsilon_2}{\epsilon_2 A_2}}$$

TRANSPORT PHENOMENA

MOMENTUM, HEAT, AND MASS TRANSFER ANALOGY

For the equations which apply to **turbulent flow in circular tubes**, the following definitions apply:

$$\text{Nu} = \text{Nusselt Number} \left[\frac{hD}{k} \right]$$

Pr = Prandtl Number ($c_p \mu / k$),

Re = Reynolds Number ($DV\rho/\mu$),

Sc = Schmidt Number [$\mu/(\rho D_m)$],

Sh = Sherwood Number ($k_m D / D_m$),

St = Stanton Number [$h/(c_p G)$],

c_m = concentration (mol/m^3),

c_p = heat capacity of fluid [$\text{J}/(\text{kg}\cdot\text{K})$],

D = tube inside diameter (m),

D_m = diffusion coefficient (m^2/s),

$(dc_m/dy)_w$ = concentration gradient at the wall (mol/m^4),

$(dT/dy)_w$ = temperature gradient at the wall (K/m),

$(dv/dy)_w$ = velocity gradient at the wall (s^{-1}),

f = Moody friction factor,

G = mass velocity [$\text{kg}/(\text{m}^2\cdot\text{s})$],

h = heat-transfer coefficient at the wall [$\text{W}/(\text{m}^2\cdot\text{K})$],

k = thermal conductivity of fluid [$\text{W}/(\text{m}\cdot\text{K})$],

k_m = mass-transfer coefficient (m/s),

L = length over which pressure drop occurs (m),

$(N/A)_w$ = inward mass-transfer flux at the wall [$\text{mol}/(\text{m}^2\cdot\text{s})$],

$(\dot{Q}/A)_w$ = inward heat-transfer flux at the wall (W/m^2),

y = distance measured from inner wall toward centerline (m),

Δc_m = concentration difference between wall and bulk fluid (mol/m^3),

ΔT = temperature difference between wall and bulk fluid (K),

μ = absolute dynamic viscosity ($\text{N}\cdot\text{s}/\text{m}^2$), and

τ_w = shear stress (momentum flux) at the tube wall (N/m^2).

Definitions already introduced also apply.

Rate of transfer as a function of gradients at the wall

Momentum Transfer:

$$\tau_w = -\mu \left(\frac{dv}{dy} \right)_w = -\frac{f\rho V^2}{8} = \left(\frac{D}{4} \right) \left(-\frac{\Delta p}{L} \right)_f$$

Heat Transfer:

$$\left(\frac{\dot{Q}}{A} \right)_w = -k \left(\frac{dT}{dy} \right)_w$$

Mass Transfer in Dilute Solutions:

$$\left(\frac{N}{A} \right)_w = -D_m \left(\frac{dc_m}{dy} \right)_w$$

Rate of transfer in terms of coefficients

Momentum Transfer:

$$\tau_w = \frac{f \rho V^2}{8}$$

Heat Transfer:

$$\left(\frac{\dot{Q}}{A} \right)_w = h\Delta T$$

Mass Transfer:

$$\left(\frac{N}{A} \right)_w = k_m \Delta c_m$$

Use of friction factor (f) to predict heat-transfer and mass-transfer coefficients (turbulent flow)

Heat Transfer:

$$j_H = \left(\frac{\text{Nu}}{\text{Re Pr}} \right) \text{Pr}^{2/3} = \frac{f}{8}$$

Mass Transfer:

$$j_M = \left(\frac{\text{Sh}}{\text{Re Sc}} \right) \text{Sc}^{2/3} = \frac{f}{8}$$

CHEMISTRY

Avogadro's Number: The number of elementary particles in a mol of a substance.

$$1 \text{ mol} = 1 \text{ gram-mole}$$

$$1 \text{ mol} = 6.02 \times 10^{23} \text{ particles}$$

A *mol* is defined as an amount of a substance that contains as many particles as 12 grams of ^{12}C (carbon 12). The elementary particles may be atoms, molecules, ions, or electrons.

ACIDS AND BASES (aqueous solutions)

$$\text{pH} = \log_{10} \left(\frac{1}{[\text{H}^+]} \right), \text{ where}$$

$[\text{H}^+]$ = molar concentration of hydrogen ion,

Acids have $\text{pH} < 7$.

Bases have $\text{pH} > 7$.

ELECTROCHEMISTRY

Cathode – The electrode at which reduction occurs.

Anode – The electrode at which oxidation occurs.

Oxidation – The loss of electrons.

Reduction – The gaining of electrons.

Oxidizing Agent – A species that causes others to become oxidized.

Reducing Agent – A species that causes others to be reduced.

Cation – Positive ion

Anion – Negative ion

DEFINITIONS

Molarity of Solutions – The number of gram moles of a substance dissolved in a liter of solution.

Molality of Solutions – The number of gram moles of a substance per 1,000 grams of solvent.

Normality of Solutions – The product of the molarity of a solution and the number of valences taking place in a reaction.

Equivalent Mass – The number of parts by mass of an element or compound which will combine with or replace directly or indirectly 1.008 parts by mass of hydrogen, 8.000 parts of oxygen, or the equivalent mass of any other element or compound. For all elements, the atomic mass is the product of the equivalent mass and the valence.

Molar Volume of an Ideal Gas [at 0°C (32°F) and 1 atm (14.7 psia)]; 22.4 L/(g mole) [359 ft³/(lb mole)].

Mole Fraction of a Substance – The ratio of the number of moles of a substance to the total moles present in a mixture of substances. Mixture may be a solid, a liquid solution, or a gas.

Equilibrium Constant of a Chemical Reaction

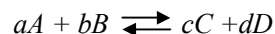

$$K_{\text{eq}} = \frac{[\text{C}]^c [\text{D}]^d}{[\text{A}]^a [\text{B}]^b}$$

Le Chatelier's Principle for Chemical Equilibrium – When a stress (such as a change in concentration, pressure, or temperature) is applied to a system in equilibrium, the equilibrium shifts in such a way that tends to relieve the stress.

Heats of Reaction, Solution, Formation, and Combustion – Chemical processes generally involve the absorption or evolution of heat. In an endothermic process, heat is absorbed (enthalpy change is positive). In an exothermic process, heat is evolved (enthalpy change is negative).

Solubility Product of a slightly soluble substance AB :



Solubility Product Constant = $K_{\text{SP}} = [\text{A}^+]^m [\text{B}^-]^n$

Metallic Elements – In general, metallic elements are distinguished from non-metallic elements by their luster, malleability, conductivity, and usual ability to form positive ions.

Non-Metallic Elements – In general, non-metallic elements are not malleable, have low electrical conductivity, and rarely form positive ions.

Faraday's Law – In the process of electrolytic changes, equal quantities of electricity charge or discharge equivalent quantities of ions at each electrode. One gram equivalent weight of matter is chemically altered at each electrode for 96,485 coulombs, or one Faraday, of electricity passed through the electrolyte.

A *catalyst* is a substance that alters the rate of a chemical reaction and may be recovered unaltered in nature and amount at the end of the reaction. The catalyst does not affect the position of equilibrium of a reversible reaction.

The *atomic number* is the number of protons in the atomic nucleus. The atomic number is the essential feature which distinguishes one element from another and determines the position of the element in the periodic table.

Boiling Point Elevation – The presence of a non-volatile solute in a solvent raises the boiling point of the resulting solution compared to the pure solvent; i.e., to achieve a given vapor pressure, the temperature of the solution must be higher than that of the pure substance.

Freezing Point Depression – The presence of a non-volatile solute in a solvent lowers the freezing point of the resulting solution compared to the pure solvent.

PERIODIC TABLE OF ELEMENTS

1 H 1.0079	<table border="1" style="margin: auto;"> <tr> <td style="text-align: center;">Atomic Number</td> </tr> <tr> <td style="text-align: center;">Symbol</td> </tr> <tr> <td style="text-align: center;">Atomic Weight</td> </tr> </table>																Atomic Number	Symbol	Atomic Weight	2 He 4.0026
Atomic Number																				
Symbol																				
Atomic Weight																				
3 Li 6.941	4 Be 9.0122											5 B 10.811	6 C 12.011	7 N 14.007	8 O 15.999	9 F 18.998	10 Ne 20.179			
11 Na 22.990	12 Mg 24.305											13 Al 26.981	14 Si 28.086	15 P 30.974	16 S 32.066	17 Cl 35.453	18 Ar 39.948			
19 K 39.098	20 Ca 40.078	21 Sc 44.956	22 Ti 47.88	23 V 50.941	24 Cr 51.996	25 Mn 54.938	26 Fe 55.847	27 Co 58.933	28 Ni 58.69	29 Cu 63.546	30 Zn 65.39	31 Ga 69.723	32 Ge 72.61	33 As 74.921	34 Se 78.96	35 Br 79.904	36 Kr 83.80			
37 Rb 85.468	38 Sr 87.62	39 Y 88.906	40 Zr 91.224	41 Nb 92.906	42 Mo 95.94	43 Tc (98)	44 Ru 101.07	45 Rh 102.91	46 Pd 106.42	47 Ag 107.87	48 Cd 112.41	49 In 114.82	50 Sn 118.71	51 Sb 121.75	52 Te 127.60	53 I 126.90	54 Xe 131.29			
55 Cs 132.91	56 Ba 137.33	57* La 138.91	72 Hf 178.49	73 Ta 180.95	74 W 183.85	75 Re 186.21	76 Os 190.2	77 Ir 192.22	78 Pt 195.08	79 Au 196.97	80 Hg 200.59	81 Tl 204.38	82 Pb 207.2	83 Bi 208.98	84 Po (209)	85 At (210)	86 Rn (222)			
87 Fr (223)	88 Ra 226.02	89** Ac 227.03	104 Rf (261)	105 Ha (262)																
*Lanthanide Series			58 Ce 140.12	59 Pr 140.91	60 Nd 144.24	61 Pm (145)	62 Sm 150.36	63 Eu 151.96	64 Gd 157.25	65 Tb 158.92	66 Dy 162.50	67 Ho 164.93	68 Er 167.26	69 Tm 168.93	70 Yb 173.04	71 Lu 174.97				
**Actinide Series			90 Th 232.04	91 Pa 231.04	92 U 238.03	93 Np 237.05	94 Pu (244)	95 Am (243)	96 Cm (247)	97 Bk (247)	98 Cf (251)	99 Es (252)	100 Fm (257)	101 Md (258)	102 No (259)	103 Lr (260)				

IMPORTANT FAMILIES OF ORGANIC COMPOUNDS

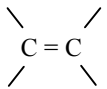
	FAMILY										
	Alkane	Alkene	Alkyne	Arene	Haloalkane	Alcohol	Ether	Amine	Aldehyde	Carboxylic Acid	Ester
Specific Example	CH_3CH_3	$\text{H}_2\text{C} = \text{CH}_2$	$\text{HC} \equiv \text{CH}$		$\text{CH}_3\text{CH}_2\text{Cl}$	$\text{CH}_3\text{CH}_2\text{OH}$	CH_3OCH_3	CH_3NH_2	$\begin{array}{c} \text{O} \\ \\ \text{CH}_3\text{CH} \end{array}$	$\begin{array}{c} \text{O} \\ \\ \text{CH}_3\text{COH} \end{array}$	$\begin{array}{c} \text{O} \\ \\ \text{CH}_3\text{COCH} \end{array}$
IUPAC Name	Ethane	Ethene or Ethylene	Ethyne or Acetylene	Benzene	Chloroethane	Ethanol	Methoxy- methane	Methan- amine	Ethanal	Ethanoic Acid	Methyl ethanoate
Common Name	Ethane	Ethylene	Acetylene	Benzene	Ethyl chloride	Ethyl alcohol	Dimethyl ether	Methyl- amine	Acetal- dehyde	Acetic Acid	Methyl acetate
General Formula	RH	$\text{RCH} = \text{CH}_2$ $\text{RCH} = \text{CHR}$ $\text{R}_2\text{C} = \text{CHR}$ $\text{R}_2\text{C} = \text{CR}_2$	$\text{RC} \equiv \text{CH}$ $\text{RC} \equiv \text{CR}$	ArH	RX	ROH	ROR	RNH_2 R_2NH R_3N	$\begin{array}{c} \text{O} \\ \\ \text{RCH} \end{array}$	$\begin{array}{c} \text{O} \\ \\ \text{RCOH} \end{array}$	$\begin{array}{c} \text{O} \\ \\ \text{RCOR} \end{array}$
Functional Group	C-H and C-C bonds		$-\text{C} \equiv \text{C}-$	Aromatic Ring	$\begin{array}{c} \\ -\text{C}-\text{X} \\ \end{array}$	$\begin{array}{c} \\ -\text{C}-\text{OH} \\ \end{array}$	$\begin{array}{c} \quad \\ -\text{C}-\text{O}-\text{C}- \\ \quad \end{array}$	$\begin{array}{c} \quad \\ -\text{C}-\text{N}- \\ \quad \end{array}$	$\begin{array}{c} \text{O} \\ \\ -\text{C}-\text{H} \end{array}$	$\begin{array}{c} \text{O} \\ \\ -\text{C}-\text{OH} \end{array}$	$\begin{array}{c} \text{O} \\ \\ -\text{C}-\text{O}-\text{C}- \\ \quad \end{array}$

Standard Oxidation Potentials for Corrosion Reactions*	
Corrosion Reaction	Potential, E_o , Volts vs. Normal Hydrogen Electrode
$\text{Au} \rightarrow \text{Au}^{3+} + 3\text{e}$	-1.498
$2\text{H}_2\text{O} \rightarrow \text{O}_2 + 4\text{H}^+ + 4\text{e}$	-1.229
$\text{Pt} \rightarrow \text{Pt}^{2+} + 2\text{e}$	-1.200
$\text{Pd} \rightarrow \text{Pd}^{2+} + 2\text{e}$	-0.987
$\text{Ag} \rightarrow \text{Ag}^+ + \text{e}$	-0.799
$2\text{Hg} \rightarrow \text{Hg}_2^{2+} + 2\text{e}$	-0.788
$\text{Fe}^{2+} \rightarrow \text{Fe}^{3+} + \text{e}$	-0.771
$4(\text{OH})^- \rightarrow \text{O}_2 + 2\text{H}_2\text{O} + 4\text{e}$	-0.401
$\text{Cu} \rightarrow \text{Cu}^{2+} + 2\text{e}$	-0.337
$\text{Sn}^{2+} \rightarrow \text{Sn}^{4+} + 2\text{e}$	-0.150
$\text{H}_2 \rightarrow 2\text{H}^+ + 2\text{e}$	0.000
$\text{Pb} \rightarrow \text{Pb}^{2+} + 2\text{e}$	+0.126
$\text{Sn} \rightarrow \text{Sn}^{2+} + 2\text{e}$	+0.136
$\text{Ni} \rightarrow \text{Ni}^{2+} + 2\text{e}$	+0.250
$\text{Co} \rightarrow \text{Co}^{2+} + 2\text{e}$	+0.277
$\text{Cd} \rightarrow \text{Cd}^{2+} + 2\text{e}$	+0.403
$\text{Fe} \rightarrow \text{Fe}^{2+} + 2\text{e}$	+0.440
$\text{Cr} \rightarrow \text{Cr}^{3+} + 3\text{e}$	+0.744
$\text{Zn} \rightarrow \text{Zn}^{2+} + 2\text{e}$	+0.763
$\text{Al} \rightarrow \text{Al}^{3+} + 3\text{e}$	+1.662
$\text{Mg} \rightarrow \text{Mg}^{2+} + 2\text{e}$	+2.363
$\text{Na} \rightarrow \text{Na}^+ + \text{e}$	+2.714
$\text{K} \rightarrow \text{K}^+ + \text{e}$	+2.925

* Measured at 25°C. Reactions are written as anode half-cells. Arrows are reversed for cathode half-cells.

Flinn, Richard A. and Paul K. Trojan, *Engineering Materials and Their Applications*, 4th Edition. Copyright © 1990 by Houghton Mifflin Company. Table used with permission.

NOTE: In some chemistry texts, the reactions and the signs of the values (in this table) are reversed; for example, the half-cell potential of zinc is given as -0.763 volt for the reaction $\text{Zn}^{2+} + 2\text{e} \rightarrow \text{Zn}$. When the potential E_o is positive, the reaction proceeds spontaneously as written.

MATERIALS SCIENCE/STRUCTURE OF MATTER

CRYSTALLOGRAPHY

Common Metallic Crystal Structures

body-centered cubic, face-centered cubic, and hexagonal close-packed.

◆
Body-
Centered
Cubic
(BCC)

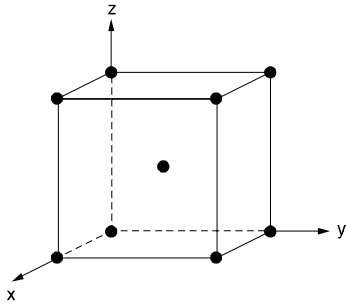

Face-
Centered
Cubic
(FCC)

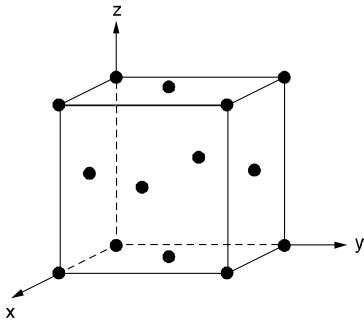

Hexagonal
Close-Packed
(HCP)

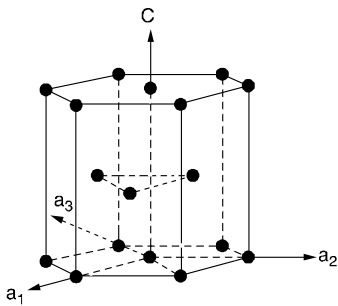

Number of Atoms in a Cell

BCC: 2

FCC: 4

HCP: 6

Packing Factor

The packing factor is the volume of the atoms in a cell (assuming touching, hard spheres) divided by the total cell volume.

BCC: 0.68

FCC: 0.74

HCP: 0.74

Coordination Number

The coordination number is the number of closest neighboring (touching) atoms in a given lattice.

Miller Indices

The rationalized reciprocal intercepts of the intersections of the plane with the crystallographic axes:

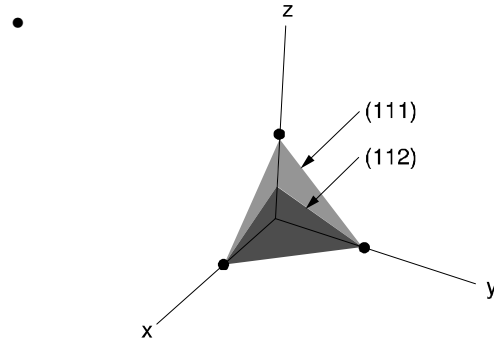

(111) plane. (axis intercepts at $x = y = z$)

(112) plane. (axis intercepts at $x = 1, y = 1, z = 1/2$)

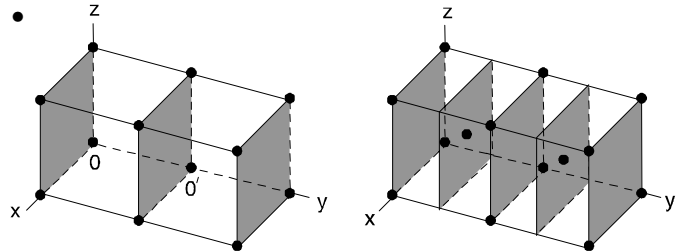

(a)

(b)

(010) planes in cubic structures. (a) Simple cubic. (b) BCC. (axis intercepts at $x = \infty, y = 1, z = \infty$)

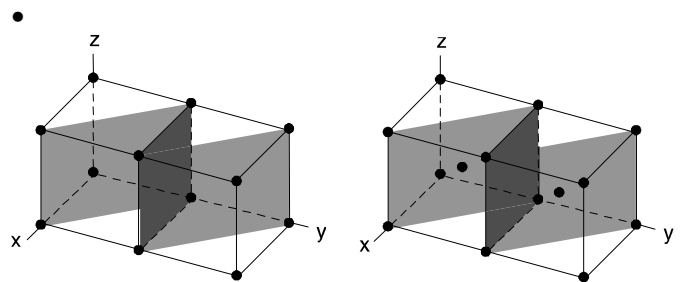

(a)

(b)

(110) planes in cubic structures. (a) Simple cubic. (b) BCC. (axis intercepts at $x = 1, y = 1, z = \infty$)

ATOMIC BONDING

Primary Bonds

Ionic (e.g., salts, metal oxides)

Covalent (e.g., within polymer molecules)

Metallic (e.g., metals)

◆ Flinn, Richard A. & Paul K. Trojan, *Engineering Materials & Their Application*, 4th Ed. Copyright © 1990 by Houghton Mifflin Co. Figure used with permission.

◆ Van Vlack, L., *Elements of Materials Science & Engineering*. Copyright © 1989 by Addison-Wesley Publishing Co., Inc. Diagram reprinted with permission of the publisher.

CORROSION

A table listing the standard electromotive potentials of metals is shown on page 67.

For corrosion to occur, there must be an anode and a cathode in electrical contact in the presence of an electrolyte.

Anode Reaction (oxidation)



Possible Cathode Reactions (reduction)

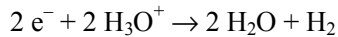
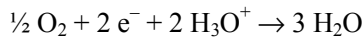
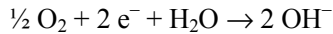

When dissimilar metals are in contact, the more electropositive one becomes the anode in a corrosion cell. Different regions of carbon steel can also result in a corrosion reaction: e.g., cold-worked regions are anodic to non-cold-worked; different oxygen concentrations can cause oxygen-deficient region to become cathodic to oxygen-rich regions; grain boundary regions are anodic to bulk grain; in multiphase alloys, various phases may not have the same galvanic potential.

DIFFUSION

Diffusion coefficient

$$D = D_0 e^{-Q/(RT)}, \text{ where}$$

D = the diffusion coefficient,

D_0 = the proportionality constant,

Q = the activation energy,

R = the gas constant [1.987 cal/(g mol·K)], and

T = the absolute temperature.

BINARY PHASE DIAGRAMS

Allows determination of (1) what phases are present at equilibrium at any temperature and average composition, (2) the compositions of those phases, and (3) the fractions of those phases.

Eutectic reaction (liquid → two solid phases)

Eutectoid reaction (solid → two solid phases)

Peritectic reaction (liquid + solid → solid)

Pertectoid reaction (two solid phases → solid)

Lever Rule

The following phase diagram and equations illustrate how the weight of each phase in a two-phase system can be determined:

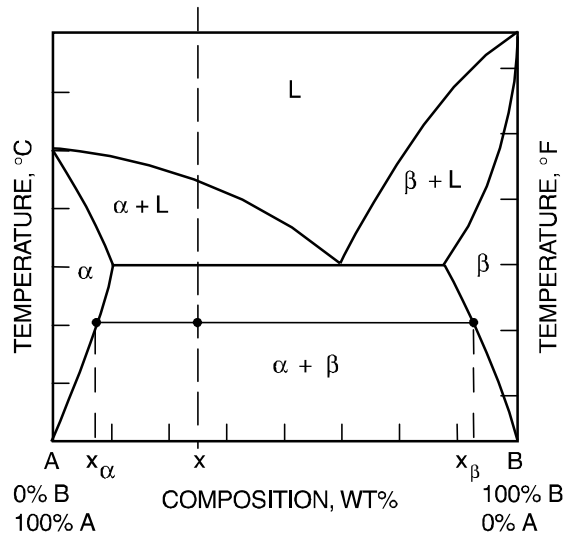

(In diagram, L = liquid) If x = the average composition at temperature T , then

$$\text{wt \% } \alpha = \frac{x_\beta - x}{x_\beta - x_\alpha} \times 100$$

$$\text{wt \% } \beta = \frac{x - x_\alpha}{x_\beta - x_\alpha} \times 100$$

Iron-Iron Carbide Phase Diagram

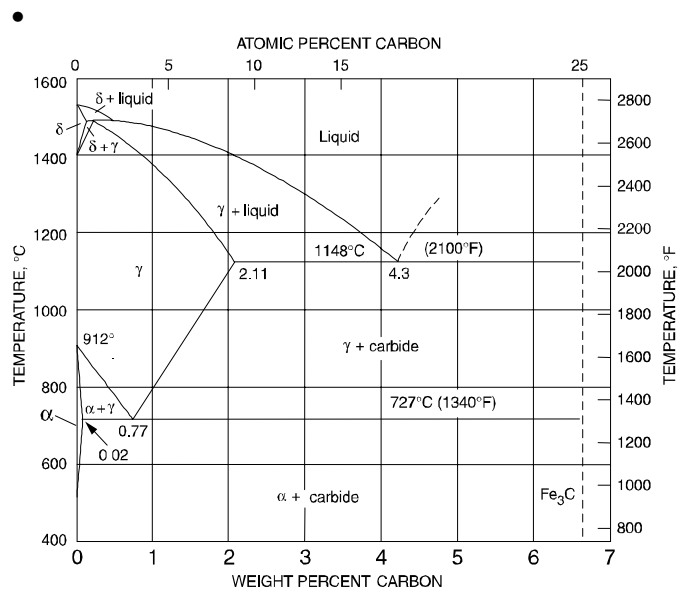

Gibbs Phase Rule

$$P + F = C + 2, \text{ where}$$

P = the number of phases that can coexist in equilibrium,

F = the number of degrees of freedom, and

C = the number of components involved.

•Van Vlack, L., *Elements of Materials Science & Engineering*, Copyright © 1989 by Addison-Wesley Publishing Co., Inc. Diagram reprinted with permission of the publisher.

THERMAL PROCESSING

Cold working (plastically deforming) a metal increases strength and lowers ductility.

Raising temperature causes (1) recovery (stress relief), (2) recrystallization, and (3) grain growth. *Hot working* allows these processes to occur simultaneously with deformation.

Quenching is rapid cooling from elevated temperature, preventing the formation of equilibrium phases.

In steels, quenching austenite [FCC (γ) iron] can result in martensite instead of equilibrium phases—ferrite [BCC (α) iron] and cementite (iron carbide).

TESTING METHODS

Standard Tensile Test

Using the standard tensile test, one can determine elastic modulus, yield strength, ultimate tensile strength, and ductility (% elongation).

Endurance Test

Endurance tests (fatigue tests to find endurance limit) apply a cyclical loading of constant maximum amplitude. The plot (usually semi-log or log-log) of the maximum stress (σ) and the number (N) of cycles to failure is known as an $S-N$ plot. (Typical of steel, may not be true for other metals; i.e., aluminum alloys, etc.)

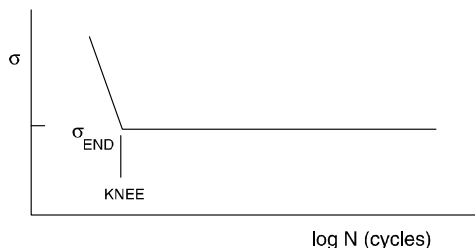

The *endurance stress* (*endurance limit* or *fatigue limit*) is the maximum stress which can be repeated indefinitely without causing failure. The *fatigue life* is the number of cycles required to cause failure for a given stress level.

Impact Test

The *Charpy Impact Test* is used to find energy required to fracture and to identify ductile to brittle transition.

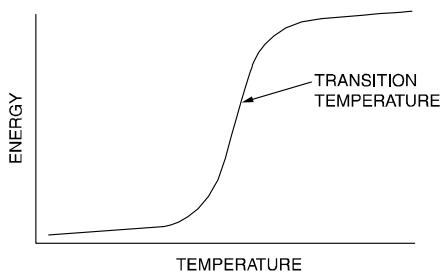

Impact tests determine the amount of energy required to cause failure in standardized test samples. The tests are repeated over a range of temperatures to determine the *transition temperature*.

HARDENABILITY

Hardenability is the "ease" with which hardness may be attained. *Hardness* is a measure of resistance to plastic deformation.

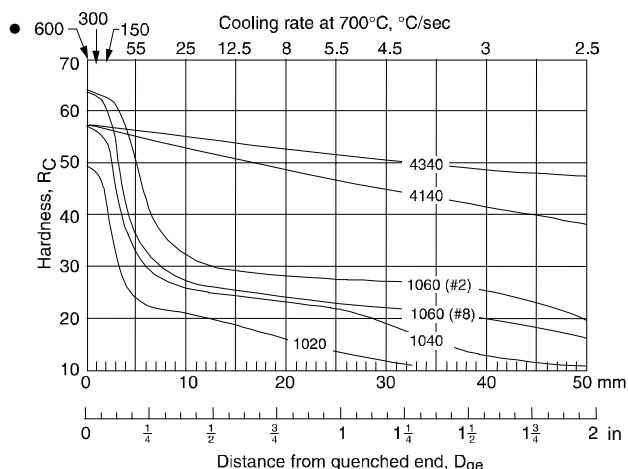

(#2) and (#8) indicated ASTM grain size

Hardenability Curves for Six Steels

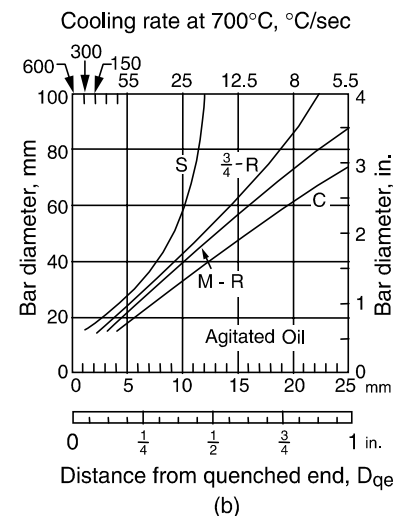
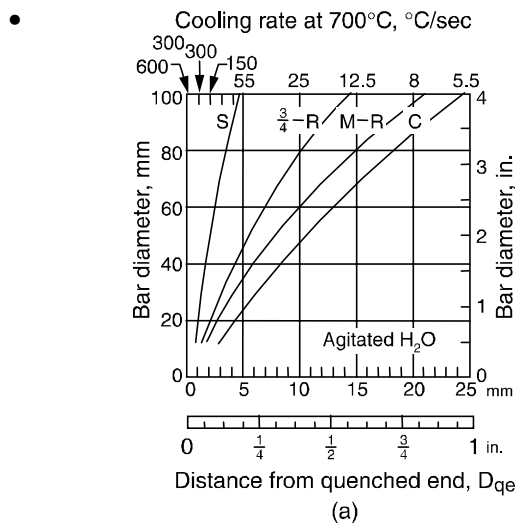

Cooling Rates for Bars Quenched in (a) Agitated Water and (b) Agitated Oil.

• Van Vlack, L., *Elements of Materials Science & Engineering*, Copyright © 1989 by Addison-Wesley Pub. Co., Inc. Diagrams reprinted with permission of the publisher.

ASTM GRAIN SIZE

$$S_V = 2P_L$$

$$N_{(0.0645 \text{ mm}^2)} = 2^{(n-1)}$$

$$\frac{N_{\text{actual}}}{\text{Actual Area}} = \frac{N}{(0.0645 \text{ mm}^2)}, \text{ where}$$

S_V = grain-boundary surface per unit volume,

P_L = number of points of intersection per unit length between the line and the boundaries,

N = number of grains observed in a area of 0.0645 mm², and

n = grain size (nearest integer > 1).

COMPOSITE MATERIALS

$$\rho_c = \sum f_i \rho_i$$

$$C_c = \sum f_i c_i$$

$$E_c = \sum f_i E_i, \text{ where}$$

ρ_c = density of composite,

C_c = heat capacity of composite per unit volume,

E_c = Young's modulus of composite,

f_i = volume fraction of individual material,

c_i = heat capacity of individual material per unit volume, and

E_i = Young's modulus of individual material.

Also

$$(\Delta L/L)_1 = (\Delta L/L)_2$$

$$(\alpha \Delta T + e)_1 = (\alpha \Delta T + e)_2$$

$$[\alpha \Delta T + (F/A)/E]_1 = [\alpha \Delta T + (F/A)/E]_2, \text{ where}$$

ΔL = change in length of a material,

L = original length of the material,

α = coefficient of expansion for a material,

ΔT = change in temperature for the material,

e = elongation of the material,

F = force in a material,

A = cross-sectional area of the material, and

E = Young's modulus for the material.

HALF-LIFE

$$N = N_o e^{-0.693t/\tau}, \text{ where}$$

N_o = original number of atoms,

N = final number of atoms,

t = time, and

τ = half-life.

Material	Density ρ Mg/m ³	Young's Modulus E GPa	E/ρ N·m/g
Aluminum	2.7	70	26,000
Steel	7.8	205	26,000
Magnesium	1.7	45	26,000
Glass	2.5	70	28,000
Polystyrene	1.05	2	2,700
Polyvinyl Chloride	1.3	< 4	< 3,500
Alumina fiber	3.9	400	100,000
Aramide fiber	1.3	125	100,000
Boron fiber	2.3	400	170,000
Beryllium fiber	1.9	300	160,000
BeO fiber	3.0	400	130,000
Carbon fiber	2.3	700	300,000
Silicon Carbide fiber	3.2	400	120,000

ELECTRIC CIRCUITS

UNITS

The basic electrical units are coulombs for charge, volts for voltage, amperes for current, and ohms for resistance and impedance.

ELECTROSTATICS

$$\mathbf{F}_2 = \frac{Q_1 Q_2}{4\pi\epsilon r^2} \mathbf{a}_{r12}, \text{ where}$$

\mathbf{F}_2 = the force on charge 2 due to charge 1,

Q_i = the i th point charge,

r = the distance between charges 1 and 2,

\mathbf{a}_{r12} = a unit vector directed from 1 to 2, and

ϵ = the permittivity of the medium.

For free space or air:

$$\epsilon = \epsilon_0 = 8.85 \times 10^{-12} \text{ Farads/meter}$$

Electrostatic Fields

Electric field intensity \mathbf{E} (volts/meter) at point 2 due to a point charge Q_1 at point 1 is

$$\mathbf{E} = \frac{Q_1}{4\pi\epsilon r^2} \mathbf{a}_{r12}$$

For a line charge of density ρ_L C/m on the z -axis, the radial electric field is

$$\mathbf{E}_L = \frac{\rho_L}{2\pi\epsilon r} \mathbf{a}_r$$

For a sheet charge of density ρ_s C/m² in the x - y plane:

$$\mathbf{E}_s = \frac{\rho_s}{2\epsilon} \mathbf{a}_z, z > 0$$

Gauss' law states that the integral of the electric flux density $\mathbf{D} = \epsilon\mathbf{E}$ over a closed surface is equal to the charge enclosed or

$$Q_{encl} = \oint_S \epsilon\mathbf{E} \cdot d\mathbf{S}$$

The force on a point charge Q in an electric field with intensity \mathbf{E} is $\mathbf{F} = Q\mathbf{E}$.

The work done by an external agent in moving a charge Q in an electric field from point p_1 to point p_2 is

$$W = -Q \int_{p_1}^{p_2} \mathbf{E} \cdot d\mathbf{l}$$

The energy stored W_E in an electric field \mathbf{E} is

$$W_E = (1/2) \iiint_V \epsilon |\mathbf{E}|^2 dv$$

Voltage

The potential difference V between two points is the work per unit charge required to move the charge between the points.

For two parallel plates with potential difference V , separated by distance d , the strength of the E field between the plates is

$$E = \frac{V}{d}$$

directed from the + plate to the - plate.

Current

Electric current $i(t)$ through a surface is defined as the rate of charge transport through that surface or

$$i(t) = dq(t)/dt, \text{ which is a function of time } t$$

since $q(t)$ denotes instantaneous charge.

A constant $i(t)$ is written as I , and the vector current density in amperes/m² is defined as \mathbf{J} .

Magnetic Fields

For a current carrying wire on the z -axis

$$\mathbf{H} = \frac{\mathbf{B}}{\mu} = \frac{I\mathbf{a}_\phi}{2\pi r}, \text{ where}$$

\mathbf{H} = the magnetic field strength (amperes/meter),

\mathbf{B} = the magnetic flux density (tesla),

\mathbf{a}_ϕ = the unit vector in positive ϕ direction in cylindrical coordinates,

I = the current, and

μ = the permeability of the medium.

For air: $\mu = \mu_0 = 4\pi \times 10^{-7}$ H/m

Force on a current carrying conductor in a uniform magnetic field is

$$\mathbf{F} = \mathbf{L} \times \mathbf{B}, \text{ where}$$

\mathbf{L} = the length vector of a conductor.

The energy stored W_H in a magnetic field \mathbf{H} is

$$W_H = (1/2) \iiint_V \mu |\mathbf{H}|^2 dv$$

Induced Voltage

Faraday's Law; For a coil of N turns enclosing flux ϕ :

$$v = -N d\phi/dt, \text{ where}$$

v = the induced voltage, and

ϕ = the flux (webers) enclosed by the N conductor turns, and

$$\phi = \int_S \mathbf{B} \cdot d\mathbf{S}$$

Resistivity

For a conductor of length L , electrical resistivity ρ , and area A , the resistance is

$$R = \frac{\rho L}{A}$$

For metallic conductors, the resistivity and resistance vary linearly with changes in temperature according to the following relationships:

$$\rho = \rho_0 [1 + \alpha (T - T_0)], \text{ and}$$

$$R = R_0 [1 + \alpha (T - T_0)], \text{ where}$$

ρ_0 is resistivity at T_0 , R_0 is the resistance at T_0 , and

α is the temperature coefficient.

Ohm's Law: $V = IR$; $v(t) = i(t) R$

Resistors in Series and Parallel

For series connections, the current in all resistors is the same and the equivalent resistance for n resistors in series is

$$R_T = R_1 + R_2 + \dots + R_n$$

For parallel connections of resistors, the voltage drop across each resistor is the same and the resistance for n resistors in parallel is

$$R_T = 1/(1/R_1 + 1/R_2 + \dots + 1/R_n)$$

For two resistors R_1 and R_2 in parallel

$$R_T = \frac{R_1 R_2}{R_1 + R_2}$$

Power in a Resistive Element

$$P = VI = \frac{V^2}{R} = I^2 R$$

Kirchhoff's Laws

Kirchhoff's voltage law for a closed loop is expressed by

$$\sum V_{\text{rises}} = \sum V_{\text{drops}}$$

Kirchhoff's current law for a closed surface is

$$\sum I_{\text{in}} = \sum I_{\text{out}}$$

SOURCE EQUIVALENTS

For an arbitrary circuit

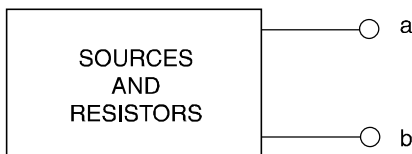

The Thévenin equivalent is

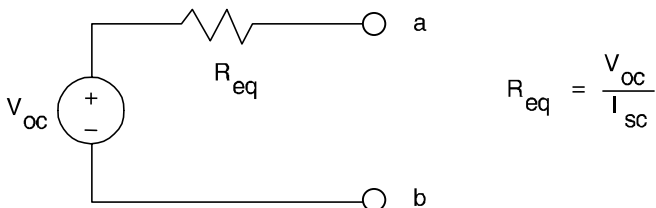

The open circuit voltage V_{oc} is $V_a - V_b$, and the short circuit current is I_{sc} from a to b .

The Norton equivalent circuit is

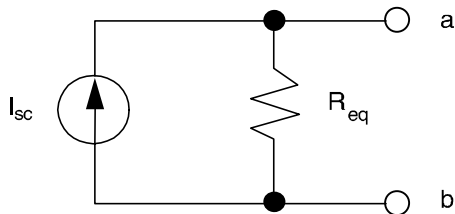

where I_{sc} and R_{eq} are defined above.

A load resistor R_L connected across terminals a and b will draw maximum power when $R_L = R_{\text{eq}}$.

CAPACITORS AND INDUCTORS

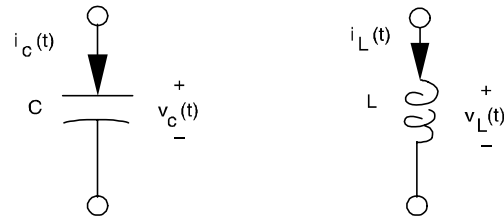

The charge $q_C(t)$ and voltage $v_C(t)$ relationship for a capacitor C in farads is

$$C = q_C(t)/v_C(t) \quad \text{or} \quad q_C(t) = C v_C(t)$$

A parallel plate capacitor of area A with plates separated a distance d by an insulator with a permittivity ϵ has a capacitance

$$C = \frac{\epsilon A}{d}$$

The current-voltage relationships for a capacitor are

$$v_C(t) = v_C(0) + \frac{1}{C} \int_0^t i_C(\tau) d\tau$$

and $i_C(t) = C (dv_C/dt)$

The energy stored in a capacitor is expressed in joules and given by

$$\text{Energy} = C v_C^2 / 2 = q_C^2 / 2C = q_C v_C / 2$$

The inductance L of a coil is

$$L = N\phi/i_L$$

and using Faraday's law, the voltage-current relations for an inductor are

$$v_L(t) = L (di_L/dt)$$

$$i_L(t) = i_L(0) + \frac{1}{L} \int_0^t v_L(\tau) d\tau, \quad \text{where}$$

v_L = inductor voltage,

L = inductance (henrys), and

i = current (amperes).

The energy stored in an inductor is expressed in joules and given by

$$\text{Energy} = L i_L^2 / 2$$

Capacitors and Inductors in Parallel and Series

Capacitors in Parallel

$$C_{\text{eq}} = C_1 + C_2 + \dots + C_n$$

Capacitors in Series

$$C_{\text{eq}} = \frac{1}{1/C_1 + 1/C_2 + \dots + 1/C_n}$$

Inductors In Parallel

$$L_{\text{eq}} = \frac{1}{1/L_1 + 1/L_2 + \dots + 1/L_n}$$

Inductors In Series

$$L_{\text{eq}} = L_1 + L_2 + \dots + L_n$$

RC AND RL TRANSIENTS

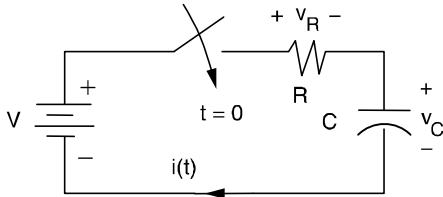

$$t \geq 0; v_C(t) = v_C(0)e^{-t/RC} + V(1 - e^{-t/RC})$$

$$i(t) = \{[V - v_C(0)]/R\}e^{-t/RC}$$

$$v_R(t) = i(t)R = [V - v_C(0)]e^{-t/RC}$$

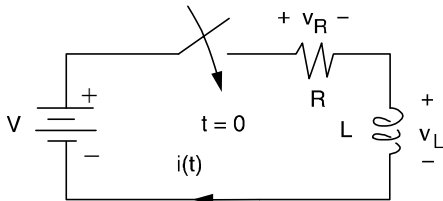

$$t \geq 0; i(t) = i(0)e^{-Rt/L} + \frac{V}{R}(1 - e^{-Rt/L})$$

$$v_R(t) = i(t)R = i(0)Re^{-Rt/L} + V(1 - e^{-Rt/L})$$

$$v_L(t) = L(di/dt) = -i(0)Re^{-Rt/L} + Ve^{-Rt/L}$$

where $v(0)$ and $i(0)$ denote the initial conditions and the parameters RC and L/R are termed the respective circuit time constants.

OPERATIONAL AMPLIFIERS

$$v_o = A(v_1 - v_2)$$

where

A is large ($> 10^4$), and

$v_1 - v_2$ is small enough so as not to saturate the amplifier.

For the ideal operational amplifier, assume that the input currents are zero and that the gain A is infinite so when operating linearly $v_2 - v_1 = 0$.

For the two-source configuration with an ideal operational amplifier,

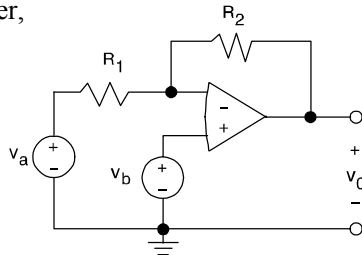

$$v_o = -\frac{R_2}{R_1}v_a + \left(1 + \frac{R_2}{R_1}\right)v_b$$

If $v_a = 0$, we have a non-inverting amplifier with

$$v_o = \left(1 + \frac{R_2}{R_1}\right)v_b$$

If $v_b = 0$, we have an inverting amplifier with

$$v_o = -\frac{R_2}{R_1}v_a$$

AC CIRCUITS

For a sinusoidal voltage or current of frequency f (Hz) and period T (seconds),

$$f = 1/T = \omega/(2\pi), \text{ where}$$

ω = the angular frequency in radians/s.

Average Value

For a periodic waveform (either voltage or current) with period T ,

$$X_{\text{ave}} = (1/T) \int_0^T x(t) dt$$

The average value of a full-wave rectified sine wave is

$$X_{\text{ave}} = (2X_{\text{max}})/\pi$$

and half this for a half-wave rectification, where

X_{max} = the peak amplitude of the waveform.

Effective or RMS Values

For a periodic waveform with period T , the rms or effective value is

$$X_{\text{rms}} = \left[(1/T) \int_0^T x^2(t) dt \right]^{1/2}$$

For a sinusoidal waveform and full-wave rectified sine wave,

$$X_{\text{rms}} = X_{\text{max}}/\sqrt{2}$$

For a half-wave rectified sine wave,

$$X_{\text{rms}} = X_{\text{max}}/2$$

Sine-Cosine Relations

$$\cos(\omega t) = \sin(\omega t + \pi/2) = -\sin(\omega t - \pi/2)$$

$$\sin(\omega t) = \cos(\omega t - \pi/2) = -\cos(\omega t + \pi/2)$$

Phasor Transforms of Sinusoids

$$P[V_{\text{max}} \cos(\omega t + \phi)] = V_{\text{rms}} \angle \phi = V$$

$$P[I_{\text{max}} \cos(\omega t + \theta)] = I_{\text{rms}} \angle \theta = I$$

For a circuit element, the impedance is defined as the ratio of phasor voltage to phasor current.

$$Z = \frac{V}{I}$$

For a Resistor,

$$Z_R = R$$

For a Capacitor,

$$Z_C = \frac{1}{j\omega C} = jX_C$$

For an Inductor,

$$Z_L = j\omega L = jX_L, \text{ where}$$

X_C and X_L are the capacitive and inductive reactances respectively defined as

$$X_C = -\frac{1}{\omega C} \quad \text{and} \quad X_L = \omega L$$

Impedances in series combine additively while those in parallel combine according to the reciprocal rule just as in the case of resistors.

Complex Power

Real power P (watts) is defined by

$$P = (1/2)V_{\max}I_{\max} \cos \theta \\ = V_{\text{rms}}I_{\text{rms}} \cos \theta$$

where θ is the angle measured from V to I . If I leads (lags) V , then the power factor ($p.f.$),

$$p.f. = \cos \theta$$

is said to be a leading (lagging) $p.f.$

Reactive power Q (vars) is defined by

$$Q = (1/2)V_{\max}I_{\max} \sin \theta \\ = V_{\text{rms}}I_{\text{rms}} \sin \theta$$

Complex power S (volt-amperes) is defined by

$$S = VI^* = P + jQ,$$

where I^* is the complex conjugate of the phasor current.

For resistors, $\theta = 0$, so the real power is

$$P = V_{\text{rms}}I_{\text{rms}} = V_{\text{rms}}^2/R = I_{\text{rms}}^2 R$$

RESONANCE

The radian resonant frequency for both parallel and series resonance situations is

$$\omega_o = \frac{1}{\sqrt{LC}} = 2\pi f_o \text{ (rad/s)}$$

Series Resonance

$$\omega_o L = \frac{1}{\omega_o C}$$

$Z = R$ at resonance.

$$Q = \frac{\omega_o L}{R} = \frac{1}{\omega_o CR}$$

$BW = \omega_o/Q$ (rad/s)

Parallel Resonance

$$\omega_o L = \frac{1}{\omega_o C} \quad \text{and}$$

$Z = R$ at resonance.

$$Q = \omega_o RC = \frac{R}{\omega_o L}$$

$BW = \omega_o/Q$ (rad/s)

TRANSFORMERS

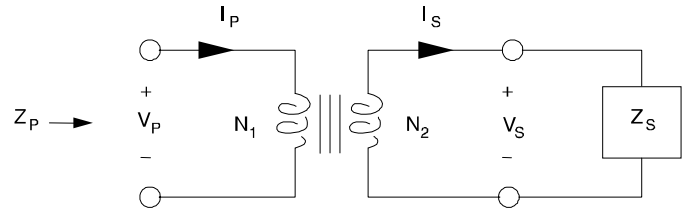

Turns Ratio

$$a = N_1/N_2 \\ a = \left| \frac{V_p}{V_s} \right| = \left| \frac{I_s}{I_p} \right|$$

The impedance seen at the input is

$$Z_p = a^2 Z_s$$

ALGEBRA OF COMPLEX NUMBERS

Complex numbers may be designated in rectangular form or polar form. In rectangular form, a complex number is written in terms of its real and imaginary components.

$$z = a + jb, \text{ where}$$

a = the real component,

b = the imaginary component, and

$$j = \sqrt{-1}$$

In polar form

$$z = c \angle \theta, \text{ where}$$

$$c = \sqrt{a^2 + b^2},$$

$$\theta = \tan^{-1}(b/a),$$

$$a = c \cos \theta, \text{ and}$$

$$b = c \sin \theta.$$

Complex numbers are added and subtracted in rectangular form. If

$$z_1 = a_1 + jb_1 = c_1 (\cos \theta_1 + j \sin \theta_1) \\ = c_1 \angle \theta_1 \text{ and}$$

$$z_2 = a_2 + jb_2 = c_2 (\cos \theta_2 + j \sin \theta_2) \\ = c_2 \angle \theta_2, \text{ then}$$

$$z_1 + z_2 = (a_1 + a_2) + j(b_1 + b_2) \text{ and}$$

$$z_1 - z_2 = (a_1 - a_2) + j(b_1 - b_2)$$

While complex numbers can be multiplied or divided in rectangular form, it is more convenient to perform these operations in polar form.

$$z_1 \times z_2 = (c_1 \times c_2) \angle \theta_1 + \theta_2$$

$$z_1/z_2 = (c_1/c_2) \angle \theta_1 - \theta_2$$

The complex conjugate of a complex number $z_1 = (a_1 + jb_1)$ is defined as $z_1^* = (a_1 - jb_1)$. The product of a complex number and its complex conjugate is $z_1 z_1^* = a_1^2 + b_1^2$.

COMPUTERS, MEASUREMENT, AND CONTROLS

COMPUTER KNOWLEDGE

Examinees are expected to possess a level of computer expertise required to perform in a typical undergraduate environment. Thus only generic problems that do not require a knowledge of a specific language or computer type will be required. Examinees are expected to be familiar with flow charts, pseudo code, and spread sheets (Lotus, Quattro-Pro, Excel, etc.).

INSTRUMENTATION

General Considerations

In making any measurement, the response of the total measurement system, including the behavior of the sensors and any signal processors, is best addressed using the methods of control systems. Response time and the effect of the sensor on the parameter being measured may affect accuracy of a measurement. Moreover, many transducers exhibit some sensitivity to phenomena other than the primary parameter being measured. All of these considerations affect accuracy, stability, noise sensitivity, and precision of any measurement. In the case of digital measurement systems, the limit of resolution corresponds to one bit.

Examples of Types of Sensors

Fluid-based sensors such as manometers, orifice and venturi flow meters, and pitot tubes are discussed in the **FLUID MECHANICS** section.

Resistance-based sensors include resistance temperature detectors (RTDs), which are metal resistors, and thermistors, which are semiconductors. Both have electrical resistivities that are temperature dependent.

Electrical-resistance strain gages are metallic or semi-conducting foils whose resistance changes with dimensional change (strain). They are widely used in load cells. The gage is attached to the surface whose strain is to be measured. The gage factor (G.F.) of these devices is defined by

$$\text{G.F.} = \frac{\Delta R/R}{\Delta L/L} = \frac{\Delta R/R}{\epsilon}, \quad \text{where}$$

R = electrical resistance,

L = the length of the gage section, and

ϵ = the normal strain sensed by the gage.

Strain gages sense normal strain along their principal axis. They do not respond to shear strain. Therefore, multiple gages must be used along with Mohr's circle techniques to determine the complete plane strain state.

Resistance-based sensors are generally used in a bridge circuit that detects small changes in resistance. The output of a bridge circuit with only one variable resistor (quarter bridge configuration) is given by

$$V_{\text{out}} = V_{\text{input}} \times [\Delta R/(4R)]$$

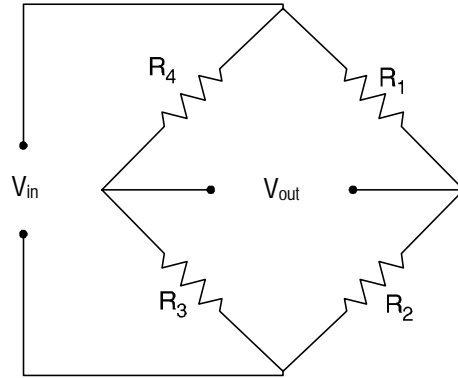

Half-bridge and full-bridge configurations use two or four variable resistors, respectively. A full-bridge strain gage circuit gives a voltage output of

$$V_{\text{out}} = V_{\text{input}} \times \text{G.F.} \times (\epsilon_1 - \epsilon_2 + \epsilon_3 - \epsilon_4)/4$$

Half- or full-strain gage bridge configurations can be developed that are sensitive to only some types of loading (axial, bending, shear) while being insensitive to others.

Piezoelectric sensors produce a voltage in response to a mechanical load. These transducers are widely used as force or pressure transducers. With the addition of an inertial mass, they are used as accelerometers.

Thermocouples are junctions of dissimilar metals which produce a voltage whose magnitude is temperature dependent.

Capacitance-based transducers are used as position sensors. The capacitance of two flat plates depends on their separation or on the area of overlap.

Inductance-based transducers or differential transformers also function as displacement transducers. The inductive coupling between a primary and secondary coil depends on the position of a soft magnetic core. This is the basis for the Linear Variable Differential Transformer (LVDT).

MEASUREMENT UNCERTAINTY

Suppose that a calculated result R depends on measurements whose values are $x_1 \pm w_1$, $x_2 \pm w_2$, $x_3 \pm w_3$, etc., where $R = f(x_1, x_2, x_3, \dots, x_n)$, x_i is the measured value, and w_i is the uncertainty in that value. The uncertainty in R , w_R , can be estimated using the Kline-McClintock equation:

$$w_R = \sqrt{\left(w_1 \frac{\partial f}{\partial x_1}\right)^2 + \left(w_2 \frac{\partial f}{\partial x_2}\right)^2 + \dots + \left(w_n \frac{\partial f}{\partial x_n}\right)^2}$$

CONTROL SYSTEMS

The linear time-invariant transfer function model represented by the block diagram



can be expressed as the ratio of two polynomials in the form

$$\frac{X(s)}{Y(s)} = G(s) = \frac{N(s)}{D(s)} = K \frac{\prod_{m=1}^M (s - z_m)}{\prod_{n=1}^N (s - p_n)}$$

where the M zeros, z_m , and the N poles, p_n , are the roots of the numerator polynomial, $N(s)$, and the denominator polynomial, $D(s)$, respectively.

One classical negative feedback control system model block diagram is

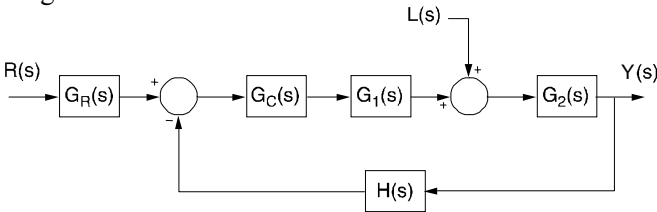

where $G_R(s)$ describes an input processor, $G_C(s)$ a controller or compensator, $G_1(s)$ and $G_2(s)$ represent a partitioned plant model, and $H(s)$ a feedback function. $Y(s)$ represents the controlled variable, $R(s)$ represents the reference input, and $L(s)$ represents a load disturbance. $Y(s)$ is related to $R(s)$ and $L(s)$ by

$$Y(s) = \frac{G_c(s)G_1(s)G_2(s)G_R(s)}{1 + G_c(s)G_1(s)G_2(s)H(s)} R(s) + \frac{G_2(s)}{1 + G_c(s)G_1(s)G_2(s)H(s)} L(s)$$

$G_C(s) G_1(s) G_2(s) H(s)$ is the open-loop transfer function. The closed-loop characteristic equation is

$$1 + G_C(s) G_1(s) G_2(s) H(s) = 0$$

System performance studies normally include:

1. Steady-state analysis using constant inputs is based on the Final Value Theorem. If all poles of a $G(s)$ function have negative real parts, then

$$\text{Steady State Gain} = \lim_{s \rightarrow 0} G(s)$$

For the unity feedback control system model

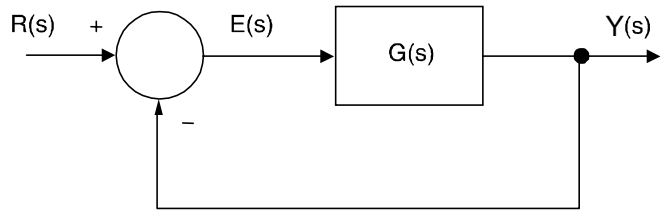

with the open-loop transfer function defined by

$$G(s) = \frac{K_B}{s^T} \times \frac{\prod_{m=1}^M (1 + s/\omega_m)}{\prod_{n=1}^N (1 + s/\omega_n)}$$

The following steady-state error analysis table can be constructed where T denotes the type of system; i.e., type 0, type 1, etc.

Steady-State Error $e_{ss}(t)$				
Input	Type	$T = 0$	$T = 1$	$T = 2$
Unit Step		$1/(K_B + 1)$	0	0
Ramp		∞	$1/K_B$	0
Acceleration		∞	∞	$1/K_B$

2. Frequency response evaluations to determine dynamic performance and stability. For example, relative stability can be quantified in terms of

- a. Gain margin (GM) which is the additional gain required to produce instability in the unity gain feedback control system. If at $\omega = \omega_{180}$,

$$\angle G(j\omega_{180}) = -180^\circ; \text{ then}$$

$$GM = -20 \log_{10} (|G(j\omega_{180})|)$$

- b. Phase margin (PM) which is the additional phase required to produce instability. Thus,

$$PM = 180^\circ + \angle G(j\omega_{0dB})$$

where ω_{0dB} is the ω that satisfies $|G(j\omega)| = 1$.

3. Transient responses are obtained by using Laplace Transforms or computer solutions with numerical integration.

Common Compensator/Controller forms are

$$\text{PID Controller } G_C(s) = K \left(1 + \frac{1}{T_I s} + T_D s \right)$$

$$\text{Lag or Lead Compensator } G_C(s) = K \left(\frac{1 + sT_1}{1 + sT_2} \right)$$

depending on the ratio of T_1/T_2 .

Routh Test

For the characteristic equation

$$a_n s^n + a_{n-1} s^{n-1} + a_{n-2} s^{n-2} + \dots + a_0 = 0$$

the coefficients are arranged into the first two rows of an array. Additional rows are computed. The array and coefficient computations are defined by:

$$\begin{array}{cccccc} a_n & a_{n-2} & a_{n-4} & \dots & \dots & \dots \\ a_{n-1} & a_{n-3} & a_{n-5} & \dots & \dots & \dots \\ b_1 & b_2 & b_3 & \dots & \dots & \dots \\ c_1 & c_2 & c_3 & \dots & \dots & \dots \end{array}$$

where

$$b_1 = \frac{a_{n-1}a_{n-2} - a_n a_{n-3}}{a_{n-1}} \quad c_1 = \frac{a_{n-3}b_1 - a_{n-1}b_2}{b_1}$$

$$b_2 = \frac{a_{n-1}a_{n-4} - a_n a_{n-5}}{a_{n-1}} \quad c_2 = \frac{a_{n-5}b_1 - a_{n-1}b_3}{b_1}$$

...

The necessary and sufficient conditions for all the roots of the equation to have negative real parts is that all the elements in the first column be of the same sign and nonzero.

Second-Order Control-System Models

One standard second-order control-system model is

$$\frac{Y(s)}{R(s)} = \frac{K\omega_n^2}{s^2 + 2\zeta\omega_n s + \omega_n^2}, \text{ where}$$

K = steady state gain,

ζ = the damping ratio,

ω_n = the undamped natural ($\zeta = 0$) frequency,

$\omega_d = \omega_n \sqrt{1 - \zeta^2}$, the damped natural frequency,

and

$\omega_p = \omega_n \sqrt{1 - 2\zeta^2}$, the damped resonant frequency.

If the damping ratio ζ is less than unity, the system is said to be underdamped; if ζ is equal to unity, it is said to be critically damped; and if ζ is greater than unity, the system is said to be overdamped.

For a unit step input to a normalized underdamped second-order control system, the time required to reach a peak value t_p and the value of that peak M_p are given by

$$t_p = \frac{\pi}{\omega_n \sqrt{1 - \zeta^2}}$$

$$M_p = 1 + e^{-\pi\zeta/\sqrt{1 - \zeta^2}}$$

For an underdamped second-order system, the logarithmic decrement is

$$\delta = \frac{1}{m} \ln \left(\frac{x_k}{x_{k+m}} \right) = \frac{2\pi\zeta}{\sqrt{1 - \zeta^2}}$$

where x_k and x_{k+m} are the amplitudes of oscillation at cycles k and $k + m$, respectively. The period of oscillation τ is related to ω_d by

$$\omega_d \tau = 2\pi$$

The time required for the output of a second-order system to settle to within 2% of its final value is defined to be

$$T_s = \frac{4}{\zeta\omega_n}$$

State-Variable Control-System Models

One common state-variable model for dynamic systems has the form

$$\dot{\mathbf{x}}(t) = \mathbf{A}\mathbf{x}(t) + \mathbf{B}\mathbf{u}(t) \quad (\text{state equation})$$

$$\mathbf{y}(t) = \mathbf{C}\mathbf{x}(t) + \mathbf{D}\mathbf{u}(t) \quad (\text{output equation})$$

where

$\mathbf{x}(t)$ = N by 1 state vector (N state variables),

$\mathbf{u}(t)$ = R by 1 input vector (R inputs),

$\mathbf{y}(t)$ = M by 1 output vector (M outputs),

\mathbf{A} = system matrix,

\mathbf{B} = input distribution matrix,

\mathbf{C} = output matrix, and

\mathbf{D} = feed-through matrix.

The orders of the matrices are defined via variable definitions.

State-variable models automatically handle multiple inputs and multiple outputs. Furthermore, state-variable models can be formulated for open-loop system components or the complete closed-loop system.

The Laplace transform of the time-invariant state equation is

$$s\mathbf{X}(s) - \mathbf{x}(0) = \mathbf{A}\mathbf{X}(s) + \mathbf{B}\mathbf{U}(s)$$

from which

$$\mathbf{X}(s) = \Phi(s) \mathbf{x}(0) + \Phi(s) \mathbf{B}\mathbf{U}(s)$$

where the Laplace transform of the state transition matrix is

$$\Phi(s) = [s\mathbf{I} - \mathbf{A}]^{-1}$$

The state-transition matrix

$$\Phi(t) = L^{-1}\{\Phi(s)\}$$

(also defined as $e^{\mathbf{A}t}$) can be used to write

$$\mathbf{x}(t) = \Phi(t) \mathbf{x}(0) + \int_0^t \Phi(t - \tau) \mathbf{B}\mathbf{u}(\tau) d\tau$$

The output can be obtained with the output equation; e.g., the Laplace transform output is

$$\mathbf{Y}(s) = \{\mathbf{C}\Phi(s) \mathbf{B} + \mathbf{D}\}\mathbf{U}(s) + \mathbf{C}\Phi(s) \mathbf{x}(0)$$

The latter term represents the output(s) due to initial conditions whereas the former term represents the output(s) due to the $\mathbf{U}(s)$ inputs and gives rise to transfer function definitions.

ENGINEERING ECONOMICS

Factor Name	Converts	Symbol	Formula
Single Payment Compound Amount	to F given P	$(F/P, i\%, n)$	$(1 + i)^n$
Single Payment Present Worth	to P given F	$(P/F, i\%, n)$	$(1 + i)^{-n}$
Uniform Series Sinking Fund	to A given F	$(A/F, i\%, n)$	$\frac{i}{(1 + i)^n - 1}$
Capital Recovery	to A given P	$(A/P, i\%, n)$	$\frac{i(1 + i)^n}{(1 + i)^n - 1}$
Uniform Series Compound Amount	to F given A	$(F/A, i\%, n)$	$\frac{(1 + i)^n - 1}{i}$
Uniform Series Present Worth	to P given A	$(P/A, i\%, n)$	$\frac{(1 + i)^n - 1}{i(1 + i)^n}$
Uniform Gradient ** Present Worth	to P given G	$(P/G, i\%, n)$	$\frac{(1 + i)^n - 1}{i^2(1 + i)^n} - \frac{n}{i(1 + i)^n}$
Uniform Gradient † Future Worth	to F given G	$(F/G, i\%, n)$	$\frac{(1 + i)^n - 1}{i^2} - \frac{n}{i}$
Uniform Gradient ‡ Uniform Series	to A given G	$(A/G, i\%, n)$	$\frac{1}{i} - \frac{n}{(1 + i)^n - 1}$

NOMENCLATURE AND DEFINITIONS

- A Uniform amount per interest period
 B Benefit
 BV Book Value
 C Cost
 d Combined interest rate per interest period
 D_j Depreciation in year j
 F Future worth, value, or amount
 f General inflation rate per interest period
 G Uniform gradient amount per interest period
 i Interest rate per interest period
 i_e Annual effective interest rate
 m Number of compounding periods per year
 n Number of compounding periods; or the expected life of an asset
 P Present worth, value, or amount
 r Nominal annual interest rate
 S_n Expected salvage value in year n

Subscripts

- j at time j
 n at time n
****** $P/G = (F/G)/(F/P) = (P/A) \times (A/G)$
† $F/G = (F/A - n)/i = (F/A) \times (A/G)$
‡ $A/G = [1 - n(A/F)]/i$

NON-ANNUAL COMPOUNDING

$$i_e = \left(1 + \frac{r}{m}\right)^m - 1$$

Discount Factors for Continuous Compounding

(n is the number of years)

$$(F/P, r\%, n) = e^{rn}$$

$$(P/F, r\%, n) = e^{-rn}$$

$$(A/F, r\%, n) = \frac{e^r - 1}{e^{rn} - 1}$$

$$(F/A, r\%, n) = \frac{e^{rn} - 1}{e^r - 1}$$

$$(A/P, r\%, n) = \frac{e^r - 1}{1 - e^{-rn}}$$

$$(P/A, r\%, n) = \frac{1 - e^{-rn}}{e^r - 1}$$

BOOK VALUE

$$BV = \text{initial cost} - \sum D_j$$

DEPRECIATION**Straight Line**

$$D_j = \frac{C - S_n}{n}$$

Accelerated Cost Recovery System (ACRS)

$$D_j = (\text{factor}) C$$

A table of modified factors is provided below.

CAPITALIZED COSTS

Capitalized costs are present worth values using an assumed perpetual period of time.

$$\text{Capitalized Costs} = P = \frac{A}{i}$$

BONDS

Bond Value equals the present worth of the payments the purchaser (or holder of the bond) receives during the life of the bond at some interest rate i .

Bond Yield equals the computed interest rate of the bond value when compared with the bond cost.

RATE-OF-RETURN

The minimum acceptable rate-of-return is that interest rate that one is willing to accept, or the rate one desires to earn on investments. The rate-of-return on an investment is the interest rate that makes the benefits and costs equal.

BREAK-EVEN ANALYSIS

By altering the value of any one of the variables in a situation, holding all of the other values constant, it is possible to find a value for that variable that makes the two alternatives equally economical. This value is the break-even point.

Break-even analysis is used to describe the percentage of capacity of operation for a manufacturing plant at which income will just cover expenses.

The payback period is the period of time required for the profit or other benefits of an investment to equal the cost of the investment.

INFLATION

To account for inflation, the dollars are deflated by the general inflation rate per interest period f , and then they are shifted over the time scale using the interest rate per interest period i . Use a combined interest rate per interest period d for computing present worth values P and Net P . The formula for d is

$$d = i + f + (i \times f)$$

BENEFIT-COST ANALYSIS

In a benefit-cost analysis, the benefits B of a project should exceed the estimated costs C .

$$B - C \geq 0, \text{ or } B/C \geq 1$$

MODIFIED ACRS FACTORS				
	Recovery Period (Years)			
	3	5	7	10
Year	Recovery Rate (Percent)			
1	33.3	20.0	14.3	10.0
2	44.5	32.0	24.5	18.0
3	14.8	19.2	17.5	14.4
4	7.4	11.5	12.5	11.5
5		11.5	8.9	9.2
6		5.8	8.9	7.4
7			8.9	6.6
8			4.5	6.6
9				6.5
10				6.5
11				3.3

Factor Table - $i = 0.50\%$

n	P/F	P/A	P/G	F/P	F/A	A/P	A/F	A/G
1	0.9950	0.9950	0.0000	1.0050	1.0000	1.0050	1.0000	0.0000
2	0.9901	1.9851	0.9901	1.0100	2.0050	0.5038	0.4988	0.4988
3	0.9851	2.9702	2.9604	1.0151	3.0150	0.3367	0.3317	0.9967
4	0.9802	3.9505	5.9011	1.0202	4.0301	0.2531	0.2481	1.4938
5	0.9754	4.9259	9.8026	1.0253	5.0503	0.2030	0.1980	1.9900
6	0.9705	5.8964	14.6552	1.0304	6.0755	0.1696	0.1646	2.4855
7	0.9657	6.8621	20.4493	1.0355	7.1059	0.1457	0.1407	2.9801
8	0.9609	7.8230	27.1755	1.0407	8.1414	0.1278	0.1228	3.4738
9	0.9561	8.7791	34.8244	1.0459	9.1821	0.1139	0.1089	3.9668
10	0.9513	9.7304	43.3865	1.0511	10.2280	0.1028	0.0978	4.4589
11	0.9466	10.6770	52.8526	1.0564	11.2792	0.0937	0.0887	4.9501
12	0.9419	11.6189	63.2136	1.0617	12.3356	0.0861	0.0811	5.4406
13	0.9372	12.5562	74.4602	1.0670	13.3972	0.0796	0.0746	5.9302
14	0.9326	13.4887	86.5835	1.0723	14.4642	0.0741	0.0691	6.4190
15	0.9279	14.4166	99.5743	1.0777	15.5365	0.0694	0.0644	6.9069
16	0.9233	15.3399	113.4238	1.0831	16.6142	0.0652	0.0602	7.3940
17	0.9187	16.2586	128.1231	1.0885	17.6973	0.0615	0.0565	7.8803
18	0.9141	17.1728	143.6634	1.0939	18.7858	0.0582	0.0532	8.3658
19	0.9096	18.0824	160.0360	1.0994	19.8797	0.0553	0.0503	8.8504
20	0.9051	18.9874	177.2322	1.1049	20.9791	0.0527	0.0477	9.3342
21	0.9006	19.8880	195.2434	1.1104	22.0840	0.0503	0.0453	9.8172
22	0.8961	20.7841	214.0611	1.1160	23.1944	0.0481	0.0431	10.2993
23	0.8916	21.6757	233.6768	1.1216	24.3104	0.0461	0.0411	10.7806
24	0.8872	22.5629	254.0820	1.1272	25.4320	0.0443	0.0393	11.2611
25	0.8828	23.4456	275.2686	1.1328	26.5591	0.0427	0.0377	11.7407
30	0.8610	27.7941	392.6324	1.1614	32.2800	0.0360	0.0310	14.1265
40	0.8191	36.1722	681.3347	1.2208	44.1588	0.0276	0.0226	18.8359
50	0.7793	44.1428	1,035.6966	1.2832	56.6452	0.0227	0.0177	23.4624
60	0.7414	51.7256	1,448.6458	1.3489	69.7700	0.0193	0.0143	28.0064
100	0.6073	78.5426	3,562.7934	1.6467	129.3337	0.0127	0.0077	45.3613

Factor Table - $i = 1.00\%$

n	P/F	P/A	P/G	F/P	F/A	A/P	A/F	A/G
1	0.9901	0.9901	0.0000	1.0100	1.0000	1.0100	1.0000	0.0000
2	0.9803	1.9704	0.9803	1.0201	2.0100	0.5075	0.4975	0.4975
3	0.9706	2.9410	2.9215	1.0303	3.0301	0.3400	0.3300	0.9934
4	0.9610	3.9020	5.8044	1.0406	4.0604	0.2563	0.2463	1.4876
5	0.9515	4.8534	9.6103	1.0510	5.1010	0.2060	0.1960	1.9801
6	0.9420	5.7955	14.3205	1.0615	6.1520	0.1725	0.1625	2.4710
7	0.9327	6.7282	19.9168	1.0721	7.2135	0.1486	0.1386	2.9602
8	0.9235	7.6517	26.3812	1.0829	8.2857	0.1307	0.1207	3.4478
9	0.9143	8.5650	33.6959	1.0937	9.3685	0.1167	0.1067	3.9337
10	0.9053	9.4713	41.8435	1.1046	10.4622	0.1056	0.0956	4.4179
11	0.8963	10.3676	50.8067	1.1157	11.5668	0.0965	0.0865	4.9005
12	0.8874	11.2551	60.5687	1.1268	12.6825	0.0888	0.0788	5.3815
13	0.8787	12.1337	71.1126	1.1381	13.8093	0.0824	0.0724	5.8607
14	0.8700	13.0037	82.4221	1.1495	14.9474	0.0769	0.0669	6.3384
15	0.8613	13.8651	94.4810	1.1610	16.0969	0.0721	0.0621	6.8143
16	0.8528	14.7179	107.2734	1.1726	17.2579	0.0679	0.0579	7.2886
17	0.8444	15.5623	120.7834	1.1843	18.4304	0.0643	0.0543	7.7613
18	0.8360	16.3983	134.9957	1.1961	19.6147	0.0610	0.0510	8.2323
19	0.8277	17.2260	149.8950	1.2081	20.8109	0.0581	0.0481	8.7017
20	0.8195	18.0456	165.4664	1.2202	22.0190	0.0554	0.0454	9.1694
21	0.8114	18.8570	181.6950	1.2324	23.2392	0.0530	0.0430	9.6354
22	0.8034	19.6604	198.5663	1.2447	24.4716	0.0509	0.0409	10.0998
23	0.7954	20.4558	216.0660	1.2572	25.7163	0.0489	0.0389	10.5626
24	0.7876	21.2434	234.1800	1.2697	26.9735	0.0471	0.0371	11.0237
25	0.7798	22.0232	252.8945	1.2824	28.2432	0.0454	0.0354	11.4831
30	0.7419	25.8077	355.0021	1.3478	34.7849	0.0387	0.0277	13.7557
40	0.6717	32.8347	596.8561	1.4889	48.8864	0.0305	0.0205	18.1776
50	0.6080	39.1961	879.4176	1.6446	64.4632	0.0255	0.0155	22.4363
60	0.5504	44.9550	1,192.8061	1.8167	81.6697	0.0222	0.0122	26.5333
100	0.3697	63.0289	2,605.7758	2.7048	170.4814	0.0159	0.0059	41.3426

Factor Table - $i = 1.50\%$

n	P/F	P/A	P/G	F/P	F/A	A/P	A/F	A/G
1	0.9852	0.9852	0.0000	1.0150	1.0000	1.0150	1.0000	0.0000
2	0.9707	1.9559	0.9707	1.0302	2.0150	0.5113	0.4963	0.4963
3	0.9563	2.9122	2.8833	1.0457	3.0452	0.3434	0.3284	0.9901
4	0.9422	3.8544	5.7098	1.0614	4.0909	0.2594	0.2444	1.4814
5	0.9283	4.7826	9.4229	1.0773	5.1523	0.2091	0.1941	1.9702
6	0.9145	5.6972	13.9956	1.0934	6.2296	0.1755	0.1605	2.4566
7	0.9010	6.5982	19.4018	1.1098	7.3230	0.1516	0.1366	2.9405
8	0.8877	7.4859	26.6157	1.1265	8.4328	0.1336	0.1186	3.4219
9	0.8746	8.3605	32.6125	1.1434	9.5593	0.1196	0.1046	3.9008
10	0.8617	9.2222	40.3675	1.1605	10.7027	0.1084	0.0934	4.3772
11	0.8489	10.0711	48.8568	1.1779	11.8633	0.0993	0.0843	4.8512
12	0.8364	10.9075	58.0571	1.1956	13.0412	0.0917	0.0767	5.3227
13	0.8240	11.7315	67.9454	1.2136	14.2368	0.0852	0.0702	5.7917
14	0.8118	12.5434	78.4994	1.2318	15.4504	0.0797	0.0647	6.2582
15	0.7999	13.3432	89.6974	1.2502	16.6821	0.0749	0.0599	6.7223
16	0.7880	14.1313	101.5178	1.2690	17.9324	0.0708	0.0558	7.1839
17	0.7764	14.9076	113.9400	1.2880	19.2014	0.0671	0.0521	7.6431
18	0.7649	15.6726	126.9435	1.3073	20.4894	0.0638	0.0488	8.0997
19	0.7536	16.4262	140.5084	1.3270	21.7967	0.0609	0.0459	8.5539
20	0.7425	17.1686	154.6154	1.3469	23.1237	0.0582	0.0432	9.0057
21	0.7315	17.9001	169.2453	1.3671	24.4705	0.0559	0.0409	9.4550
22	0.7207	18.6208	184.3798	1.3876	25.8376	0.0537	0.0387	9.9018
23	0.7100	19.3309	200.0006	1.4084	27.2251	0.0517	0.0367	10.3462
24	0.6995	20.0304	216.0901	1.4295	28.6335	0.0499	0.0349	10.7881
25	0.6892	20.7196	232.6310	1.4509	30.0630	0.0483	0.0333	11.2276
30	0.6398	24.0158	321.5310	1.5631	37.5387	0.0416	0.0266	13.3883
40	0.5513	29.9158	524.3568	1.8140	54.2679	0.0334	0.0184	17.5277
50	0.4750	34.9997	749.9636	2.1052	73.6828	0.0286	0.0136	21.4277
60	0.4093	39.3803	988.1674	2.4432	96.2147	0.0254	0.0104	25.0930
100	0.2256	51.6247	1,937.4506	4.4320	228.8030	0.0194	0.0044	37.5295

Factor Table - $i = 2.00\%$

n	P/F	P/A	P/G	F/P	F/A	A/P	A/F	A/G
1	0.9804	0.9804	0.0000	1.0200	1.0000	1.0200	1.0000	0.0000
2	0.9612	1.9416	0.9612	1.0404	2.0200	0.5150	0.4950	0.4950
3	0.9423	2.8839	2.8458	1.0612	3.0604	0.3468	0.3268	0.9868
4	0.9238	3.8077	5.6173	1.0824	4.1216	0.2626	0.2426	1.4752
5	0.9057	4.7135	9.2403	1.1041	5.2040	0.2122	0.1922	1.9604
6	0.8880	5.6014	13.6801	1.1262	6.3081	0.1785	0.1585	2.4423
7	0.8706	6.4720	18.9035	1.1487	7.4343	0.1545	0.1345	2.9208
8	0.8535	7.3255	24.8779	1.1717	8.5830	0.1365	0.1165	3.3961
9	0.8368	8.1622	31.5720	1.1951	9.7546	0.1225	0.1025	3.8681
10	0.8203	8.9826	38.9551	1.2190	10.9497	0.1113	0.0913	4.3367
11	0.8043	9.7868	46.9977	1.2434	12.1687	0.1022	0.0822	4.8021
12	0.7885	10.5753	55.6712	1.2682	13.4121	0.0946	0.0746	5.2642
13	0.7730	11.3484	64.9475	1.2936	14.6803	0.0881	0.0681	5.7231
14	0.7579	12.1062	74.7999	1.3195	15.9739	0.0826	0.0626	6.1786
15	0.7430	12.8493	85.2021	1.3459	17.2934	0.0778	0.0578	6.6309
16	0.7284	13.5777	96.1288	1.3728	18.6393	0.0737	0.0537	7.0799
17	0.7142	14.2919	107.5554	1.4002	20.0121	0.0700	0.0500	7.5256
18	0.7002	14.9920	119.4581	1.4282	21.4123	0.0667	0.0467	7.9681
19	0.6864	15.6785	131.8139	1.4568	22.8406	0.0638	0.0438	8.4073
20	0.6730	16.3514	144.6003	1.4859	24.2974	0.0612	0.0412	8.8433
21	0.6598	17.0112	157.7959	1.5157	25.7833	0.0588	0.0388	9.2760
22	0.6468	17.6580	171.3795	1.5460	27.2990	0.0566	0.0366	9.7055
23	0.6342	18.2922	185.3309	1.5769	28.8450	0.0547	0.0347	10.1317
24	0.6217	18.9139	199.6305	1.6084	30.4219	0.0529	0.0329	10.5547
25	0.6095	19.5235	214.2592	1.6406	32.0303	0.0512	0.0312	10.9745
30	0.5521	22.3965	291.7164	1.8114	40.5681	0.0446	0.0246	13.0251
40	0.4529	27.3555	461.9931	2.2080	60.4020	0.0366	0.0166	16.8885
50	0.3715	31.4236	642.3606	2.6916	84.5794	0.0318	0.0118	20.4420
60	0.3048	34.7609	823.6975	3.2810	114.0515	0.0288	0.0088	23.6961
100	0.1380	43.0984	1,464.7527	7.2446	312.2323	0.0232	0.0032	33.9863

Factor Table - $i = 4.00\%$

n	P/F	P/A	P/G	F/P	F/A	A/P	A/F	A/G
1	0.9615	0.9615	0.0000	1.0400	1.0000	1.0400	1.0000	0.0000
2	0.9246	1.8861	0.9246	1.0816	2.0400	0.5302	0.4902	0.4902
3	0.8890	2.7751	2.7025	1.1249	3.1216	0.3603	0.3203	0.9739
4	0.8548	3.6299	5.2670	1.1699	4.2465	0.2755	0.2355	1.4510
5	0.8219	4.4518	8.5547	1.2167	5.4163	0.2246	0.1846	1.9216
6	0.7903	5.2421	12.5062	1.2653	6.6330	0.1908	0.1508	2.3857
7	0.7599	6.0021	17.0657	1.3159	7.8983	0.1666	0.1266	2.8433
8	0.7307	6.7327	22.1806	1.3686	9.2142	0.1485	0.1085	3.2944
9	0.7026	7.4353	27.8013	1.4233	10.5828	0.1345	0.0945	3.7391
10	0.6756	8.1109	33.8814	1.4802	12.0061	0.1233	0.0833	4.1773
11	0.6496	8.7605	40.3772	1.5395	13.4864	0.1141	0.0741	4.6090
12	0.6246	9.3851	47.2477	1.6010	15.0258	0.1066	0.0666	5.0343
13	0.6006	9.9856	54.4546	1.6651	16.6268	0.1001	0.0601	5.4533
14	0.5775	10.5631	61.9618	1.7317	18.2919	0.0947	0.0547	5.8659
15	0.5553	11.1184	69.7355	1.8009	20.0236	0.0899	0.0499	6.2721
16	0.5339	11.6523	77.7441	1.8730	21.8245	0.0858	0.0458	6.6720
17	0.5134	12.1657	85.9581	1.9479	23.6975	0.0822	0.0422	7.0656
18	0.4936	12.6593	94.3498	2.0258	25.6454	0.0790	0.0390	7.4530
19	0.4746	13.1339	102.8933	2.1068	27.6712	0.0761	0.0361	7.8342
20	0.4564	13.5903	111.5647	2.1911	29.7781	0.0736	0.0336	8.2091
21	0.4388	14.0292	120.3414	2.2788	31.9692	0.0713	0.0313	8.5779
22	0.4220	14.4511	129.2024	2.3699	34.2480	0.0692	0.0292	8.9407
23	0.4057	14.8568	138.1284	2.4647	36.6179	0.0673	0.0273	9.2973
24	0.3901	15.2470	147.1012	2.5633	39.0826	0.0656	0.0256	9.6479
25	0.3751	15.6221	156.1040	2.6658	41.6459	0.0640	0.0240	9.9925
30	0.3083	17.2920	201.0618	3.2434	56.0849	0.0578	0.0178	11.6274
40	0.2083	19.7928	286.5303	4.8010	95.0255	0.0505	0.0105	14.4765
50	0.1407	21.4822	361.1638	7.1067	152.6671	0.0466	0.0066	16.8122
60	0.0951	22.6235	422.9966	10.5196	237.9907	0.0442	0.0042	18.6972
100	0.0198	24.5050	563.1249	50.5049	1,237.6237	0.0408	0.0008	22.9800

Factor Table - $i = 6.00\%$

n	P/F	P/A	P/G	F/P	F/A	A/P	A/F	A/G
1	0.9434	0.9434	0.0000	1.0600	1.0000	1.0600	1.0000	0.0000
2	0.8900	1.8334	0.8900	1.1236	2.0600	0.5454	0.4854	0.4854
3	0.8396	2.6730	2.5692	1.1910	3.1836	0.3741	0.3141	0.9612
4	0.7921	3.4651	4.9455	1.2625	4.3746	0.2886	0.2286	1.4272
5	0.7473	4.2124	7.9345	1.3382	5.6371	0.2374	0.1774	1.8836
6	0.7050	4.9173	11.4594	1.4185	6.9753	0.2034	0.1434	2.3304
7	0.6651	5.5824	15.4497	1.5036	8.3938	0.1791	0.1191	2.7676
8	0.6274	6.2098	19.8416	1.5938	9.8975	0.1610	0.1010	3.1952
9	0.5919	6.8017	24.5768	1.6895	11.4913	0.1470	0.0870	3.6133
10	0.5584	7.3601	29.6023	1.7908	13.1808	0.1359	0.0759	4.0220
11	0.5268	7.8869	34.8702	1.8983	14.9716	0.1268	0.0668	4.4213
12	0.4970	8.3838	40.3369	2.0122	16.8699	0.1193	0.0593	4.8113
13	0.4688	8.8527	45.9629	2.1329	18.8821	0.1130	0.0530	5.1920
14	0.4423	9.2950	51.7128	2.2609	21.0151	0.1076	0.0476	5.5635
15	0.4173	9.7122	57.5546	2.3966	23.2760	0.1030	0.0430	5.9260
16	0.3936	10.1059	63.4592	2.5404	25.6725	0.0990	0.0390	6.2794
17	0.3714	10.4773	69.4011	2.6928	28.2129	0.0954	0.0354	6.6240
18	0.3505	10.8276	75.3569	2.8543	30.9057	0.0924	0.0324	6.9597
19	0.3305	11.1581	81.3062	3.0256	33.7600	0.0896	0.0296	7.2867
20	0.3118	11.4699	87.2304	3.2071	36.7856	0.0872	0.0272	7.6051
21	0.2942	11.7641	93.1136	3.3996	39.9927	0.0850	0.0250	7.9151
22	0.2775	12.0416	98.9412	3.6035	43.3923	0.0830	0.0230	8.2166
23	0.2618	12.3034	104.7007	3.8197	46.9958	0.0813	0.0213	8.5099
24	0.2470	12.5504	110.3812	4.0489	50.8156	0.0797	0.0197	8.7951
25	0.2330	12.7834	115.9732	4.2919	54.8645	0.0782	0.0182	9.0722
30	0.1741	13.7648	142.3588	5.7435	79.0582	0.0726	0.0126	10.3422
40	0.0972	15.0463	185.9568	10.2857	154.7620	0.0665	0.0065	12.3590
50	0.0543	15.7619	217.4574	18.4202	290.3359	0.0634	0.0034	13.7964
60	0.0303	16.1614	239.0428	32.9877	533.1282	0.0619	0.0019	14.7909
100	0.0029	16.6175	272.0471	339.3021	5,638.3681	0.0602	0.0002	16.3711

Factor Table - $i = 8.00\%$

n	P/F	P/A	P/G	F/P	F/A	A/P	A/F	A/G
1	0.9259	0.9259	0.0000	1.0800	1.0000	1.0800	1.0000	0.0000
2	0.8573	1.7833	0.8573	1.1664	2.0800	0.5608	0.4808	0.4808
3	0.7938	2.5771	2.4450	1.2597	3.2464	0.3880	0.3080	0.9487
4	0.7350	3.3121	4.6501	1.3605	4.5061	0.3019	0.2219	1.4040
5	0.6806	3.9927	7.3724	1.4693	5.8666	0.2505	0.1705	1.8465
6	0.6302	4.6229	10.5233	1.5869	7.3359	0.2163	0.1363	2.2763
7	0.5835	5.2064	14.0242	1.7138	8.9228	0.1921	0.1121	2.6937
8	0.5403	5.7466	17.8061	1.8509	10.6366	0.1740	0.0940	3.0985
9	0.5002	6.2469	21.8081	1.9990	12.4876	0.1601	0.0801	3.4910
10	0.4632	6.7101	25.9768	2.1589	14.4866	0.1490	0.0690	3.8713
11	0.4289	7.1390	30.2657	2.3316	16.6455	0.1401	0.0601	4.2395
12	0.3971	7.5361	34.6339	2.5182	18.9771	0.1327	0.0527	4.5957
13	0.3677	7.9038	39.0463	2.7196	21.4953	0.1265	0.0465	4.9402
14	0.3405	8.2442	43.4723	2.9372	24.2149	0.1213	0.0413	5.2731
15	0.3152	8.5595	47.8857	3.1722	27.1521	0.1168	0.0368	5.5945
16	0.2919	8.8514	52.2640	3.4259	30.3243	0.1130	0.0330	5.9046
17	0.2703	9.1216	56.5883	3.7000	33.7502	0.1096	0.0296	6.2037
18	0.2502	9.3719	60.8426	3.9960	37.4502	0.1067	0.0267	6.4920
19	0.2317	9.6036	65.0134	4.3157	41.4463	0.1041	0.0241	6.7697
20	0.2145	9.8181	69.0898	4.6610	45.7620	0.1019	0.0219	7.0369
21	0.1987	10.0168	73.0629	5.0338	50.4229	0.0998	0.0198	7.2940
22	0.1839	10.2007	76.9257	5.4365	55.4568	0.0980	0.0180	7.5412
23	0.1703	10.3711	80.6726	5.8715	60.8933	0.0964	0.0164	7.7786
24	0.1577	10.5288	84.2997	6.3412	66.7648	0.0950	0.0150	8.0066
25	0.1460	10.6748	87.8041	6.8485	73.1059	0.0937	0.0137	8.2254
30	0.0994	11.2578	103.4558	10.0627	113.2832	0.0888	0.0088	9.1897
40	0.0460	11.9246	126.0422	21.7245	259.0565	0.0839	0.0039	10.5699
50	0.0213	12.2335	139.5928	46.9016	573.7702	0.0817	0.0017	11.4107
60	0.0099	12.3766	147.3000	101.2571	1,253.2133	0.0808	0.0008	11.9015
100	0.0005	12.4943	155.6107	2,199.7613	27,484.5157	0.0800		12.4545

Factor Table - $i = 10.00\%$

n	P/F	P/A	P/G	F/P	F/A	A/P	A/F	A/G
1	0.9091	0.9091	0.0000	1.1000	1.0000	1.1000	1.0000	0.0000
2	0.8264	1.7355	0.8264	1.2100	2.1000	0.5762	0.4762	0.4762
3	0.7513	2.4869	2.3291	1.3310	3.3100	0.4021	0.3021	0.9366
4	0.6830	3.1699	4.3781	1.4641	4.6410	0.3155	0.2155	1.3812
5	0.6209	3.7908	6.8618	1.6105	6.1051	0.2638	0.1638	1.8101
6	0.5645	4.3553	9.6842	1.7716	7.7156	0.2296	0.1296	2.2236
7	0.5132	4.8684	12.7631	1.9487	9.4872	0.2054	0.1054	2.6216
8	0.4665	5.3349	16.0287	2.1436	11.4359	0.1874	0.0874	3.0045
9	0.4241	5.7590	19.4215	2.3579	13.5735	0.1736	0.0736	3.3724
10	0.3855	6.1446	22.8913	2.5937	15.9374	0.1627	0.0627	3.7255
11	0.3505	6.4951	26.3962	2.8531	18.5312	0.1540	0.0540	4.0641
12	0.3186	6.8137	29.9012	3.1384	21.3843	0.1468	0.0468	4.3884
13	0.2897	7.1034	33.3772	3.4523	24.5227	0.1408	0.0408	4.6988
14	0.2633	7.3667	36.8005	3.7975	27.9750	0.1357	0.0357	4.9955
15	0.2394	7.6061	40.1520	4.1772	31.7725	0.1315	0.0315	5.2789
16	0.2176	7.8237	43.4164	4.5950	35.9497	0.1278	0.0278	5.5493
17	0.1978	8.0216	46.5819	5.0045	40.5447	0.1247	0.0247	5.8071
18	0.1799	8.2014	49.6395	5.5599	45.5992	0.1219	0.0219	6.0526
19	0.1635	8.3649	52.5827	6.1159	51.1591	0.1195	0.0195	6.2861
20	0.1486	8.5136	55.4069	6.7275	57.2750	0.1175	0.0175	6.5081
21	0.1351	8.6487	58.1095	7.4002	64.0025	0.1156	0.0156	6.7189
22	0.1228	8.7715	60.6893	8.1403	71.4027	0.1140	0.0140	6.9189
23	0.1117	8.8832	63.1462	8.9543	79.5430	0.1126	0.0126	7.1085
24	0.1015	8.9847	65.4813	9.8497	88.4973	0.1113	0.0113	7.2881
25	0.0923	9.0770	67.6964	10.8347	98.3471	0.1102	0.0102	7.4580
30	0.0573	9.4269	77.0766	17.4494	164.4940	0.1061	0.0061	8.1762
40	0.0221	9.7791	88.9525	45.2593	442.5926	0.1023	0.0023	9.0962
50	0.0085	9.9148	94.8889	117.3909	1,163.9085	0.1009	0.0009	9.5704
60	0.0033	9.9672	97.7010	304.4816	3,034.8164	0.1003	0.0003	9.8023
100	0.0001	9.9993	99.9202	13,780.6123	137,796.1234	0.1000		9.9927

Factor Table - $i = 12.00\%$

n	P/F	P/A	P/G	F/P	F/A	A/P	A/F	A/G
1	0.8929	0.8929	0.0000	1.1200	1.0000	1.1200	1.0000	0.0000
2	0.7972	1.6901	0.7972	1.2544	2.1200	0.5917	0.4717	0.4717
3	0.7118	2.4018	2.2208	1.4049	3.3744	0.4163	0.2963	0.9246
4	0.6355	3.0373	4.1273	1.5735	4.7793	0.3292	0.2092	1.3589
5	0.5674	3.6048	6.3970	1.7623	6.3528	0.2774	0.1574	1.7746
6	0.5066	4.1114	8.9302	1.9738	8.1152	0.2432	0.1232	2.1720
7	0.4523	4.5638	11.6443	2.2107	10.0890	0.2191	0.0991	2.5515
8	0.4039	4.9676	14.4714	2.4760	12.2997	0.2013	0.0813	2.9131
9	0.3606	5.3282	17.3563	2.7731	14.7757	0.1877	0.0677	3.2574
10	0.3220	5.6502	20.2541	3.1058	17.5487	0.1770	0.0570	3.5847
11	0.2875	5.9377	23.1288	3.4785	20.6546	0.1684	0.0484	3.8953
12	0.2567	6.1944	25.9523	3.8960	24.1331	0.1614	0.0414	4.1897
13	0.2292	6.4235	28.7024	4.3635	28.0291	0.1557	0.0357	4.4683
14	0.2046	6.6282	31.3624	4.8871	32.3926	0.1509	0.0309	4.7317
15	0.1827	6.8109	33.9202	5.4736	37.2797	0.1468	0.0268	4.9803
16	0.1631	6.9740	36.3670	6.1304	42.7533	0.1434	0.0234	5.2147
17	0.1456	7.1196	38.6973	6.8660	48.8837	0.1405	0.0205	5.4353
18	0.1300	7.2497	40.9080	7.6900	55.7497	0.1379	0.0179	5.6427
19	0.1161	7.3658	42.9979	8.6128	63.4397	0.1358	0.0158	5.8375
20	0.1037	7.4694	44.9676	9.6463	72.0524	0.1339	0.0139	6.0202
21	0.0926	7.5620	46.8188	10.8038	81.6987	0.1322	0.0122	6.1913
22	0.0826	7.6446	48.5543	12.1003	92.5026	0.1308	0.0108	6.3514
23	0.0738	7.7184	50.1776	13.5523	104.6029	0.1296	0.0096	6.5010
24	0.0659	7.7843	51.6929	15.1786	118.1552	0.1285	0.0085	6.6406
25	0.0588	7.8431	53.1046	17.0001	133.3339	0.1275	0.0075	6.7708
30	0.0334	8.0552	58.7821	29.9599	241.3327	0.1241	0.0041	7.2974
40	0.0107	8.2438	65.1159	93.0510	767.0914	0.1213	0.0013	7.8988
50	0.0035	8.3045	67.7624	289.0022	2,400.0182	0.1204	0.0004	8.1597
60	0.0011	8.3240	68.8100	897.5969	7,471.6411	0.1201	0.0001	8.2664
100		8.3332	69.4336	83,522.2657	696,010.5477	0.1200		8.3321

Factor Table - $i = 18.00\%$

n	P/F	P/A	P/G	F/P	F/A	A/P	A/F	A/G
1	0.8475	0.8475	0.0000	1.1800	1.0000	1.1800	1.0000	0.0000
2	0.7182	1.5656	0.7182	1.3924	2.1800	0.6387	0.4587	0.4587
3	0.6086	2.1743	1.9354	1.6430	3.5724	0.4599	0.2799	0.8902
4	0.5158	2.6901	3.4828	1.9388	5.2154	0.3717	0.1917	1.2947
5	0.4371	3.1272	5.2312	2.2878	7.1542	0.3198	0.1398	1.6728
6	0.3704	3.4976	7.0834	2.6996	9.4423	0.2859	0.1059	2.0252
7	0.3139	3.8115	8.9670	3.1855	12.1415	0.2624	0.0824	2.3526
8	0.2660	4.0776	10.8292	3.7589	15.3270	0.2452	0.0652	2.6558
9	0.2255	4.3030	12.6329	4.4355	19.0859	0.2324	0.0524	2.9358
10	0.1911	4.4941	14.3525	5.2338	23.5213	0.2225	0.0425	3.1936
11	0.1619	4.6560	15.9716	6.1759	28.7551	0.2148	0.0348	3.4303
12	0.1372	4.7932	17.4811	7.2876	34.9311	0.2086	0.0286	3.6470
13	0.1163	4.9095	18.8765	8.5994	42.2187	0.2037	0.0237	3.8449
14	0.0985	5.0081	20.1576	10.1472	50.8180	0.1997	0.0197	4.0250
15	0.0835	5.0916	21.3269	11.9737	60.9653	0.1964	0.0164	4.1887
16	0.0708	5.1624	22.3885	14.1290	72.9390	0.1937	0.0137	4.3369
17	0.0600	5.2223	23.3482	16.6722	87.0680	0.1915	0.0115	4.4708
18	0.0508	5.2732	24.2123	19.6731	103.7403	0.1896	0.0096	4.5916
19	0.0431	5.3162	24.9877	23.2144	123.4135	0.1881	0.0081	4.7003
20	0.0365	5.3527	25.6813	27.3930	146.6280	0.1868	0.0068	4.7978
21	0.0309	5.3837	26.3000	32.3238	174.0210	0.1857	0.0057	4.8851
22	0.0262	5.4099	26.8506	38.1421	206.3448	0.1848	0.0048	4.9632
23	0.0222	5.4321	27.3394	45.0076	244.4868	0.1841	0.0041	5.0329
24	0.0188	5.4509	27.7725	53.1090	289.4944	0.1835	0.0035	5.0950
25	0.0159	5.4669	28.1555	62.6686	342.6035	0.1829	0.0029	5.1502
30	0.0070	5.5168	29.4864	143.3706	790.9480	0.1813	0.0013	5.3448
40	0.0013	5.5482	30.5269	750.3783	4,163.2130	0.1802	0.0002	5.5022
50	0.0003	5.5541	30.7856	3,927.3569	21,813.0937	0.1800		5.5428
60	0.0001	5.5553	30.8465	20,555.1400	114,189.6665	0.1800		5.5526
100		5.5556	30.8642	15,424,131.91	85,689,616.17	0.1800		5.5555

ETHICS

Engineering is considered to be a "profession" rather than an "occupation" because of several important characteristics shared with other recognized learned professions, law, medicine, and theology: special knowledge, special privileges, and special responsibilities. Professions are based on a large knowledge base requiring extensive training. Professional skills are important to the well-being of society. Professions are self-regulating, in that they control the training and evaluation processes that admit new persons to the field. Professionals have autonomy in the workplace; they are expected to utilize their independent judgment in carrying out their professional responsibilities. Finally, professions are regulated by ethical standards.¹

The expertise possessed by engineers is vitally important to public welfare. In order to serve the public effectively, engineers must maintain a high level of technical competence. However, a high level of technical expertise without adherence to ethical guidelines is as much a threat to public welfare as is professional incompetence. Therefore, engineers must also be guided by ethical principles.

The ethical principles governing the engineering profession are embodied in codes of ethics. Such codes have been adopted by state boards of registration, professional engineering societies, and even by some private industries. An example of one such code is the NCEES *Model Rules of Professional Conduct*, which is presented here in its entirety. As part of his/her responsibility to the public, an engineer is responsible for knowing and abiding by the code.

The three major sections of the model rules address (1) Licensee's Obligations to Society, (2) Licensee's Obligations to Employers and Clients, and (3) Licensee's Obligations to Other Licensees. The principles amplified in these sections are important guides to appropriate behavior of professional engineers.

Application of the code in many situations is not controversial. However, there may be situations in which applying the code may raise more difficult issues. In particular, there may be circumstances in which terminology in the code is not clearly defined, or in which two sections of the code may be in conflict. For example, what constitutes "valuable consideration" or "adequate" knowledge may be interpreted differently by qualified professionals. These types of questions are called conceptual issues, in which definitions of terms may be in dispute. In other situations, factual issues may also affect ethical dilemmas. Many decisions regarding engineering design may be based upon interpretation of disputed or incomplete information. In addition, tradeoffs revolving around competing issues of risk vs. benefit, or safety vs. economics may require judgments that are not fully addressed simply by application of the code.

No code can give immediate and mechanical answers to all ethical and professional problems that an engineer may face. Creative problem solving is often called for in ethics, just as it is in other areas of engineering.

NCEES Model Rules of Professional Conduct

PREAMBLE

To comply with the purpose of the (identify jurisdiction, licensing statute)—which is to safeguard life, health, and property, to promote the public welfare, and to maintain a high standard of integrity and practice—the (identify board, licensing statute) has developed the following *Rules of Professional Conduct*. These rules shall be binding on every person holding a certificate of licensure to offer or perform engineering or land surveying services in this state. All persons licensed under (identify jurisdiction's licensing statute) are required to be familiar with the licensing statute and these rules. The *Rules of Professional Conduct* delineate specific obligations the licensee must meet. In addition, each licensee is charged with the responsibility of adhering to the highest standards of ethical and moral conduct in all aspects of the practice of professional engineering and land surveying.

The practice of professional engineering and land surveying is a privilege, as opposed to a right. All licensees shall exercise their privilege of practicing by performing services only in the areas of their competence according to current standards of technical competence.

Licensees shall recognize their responsibility to the public and shall represent themselves before the public only in an objective and truthful manner.

They shall avoid conflicts of interest and faithfully serve the legitimate interests of their employers, clients, and customers within the limits defined by these rules. Their professional reputation shall be built on the merit of their services, and they shall not compete unfairly with others.

The *Rules of Professional Conduct* as promulgated herein are enforced under the powers vested by (identify jurisdiction's enforcing agency). In these rules, the word "licensee" shall mean any person holding a license or a certificate issued by (identify jurisdiction's licensing agency).

¹ Harris, C.E., M.S. Pritchard, & M.J. Rabins, *Engineering Ethics: Concepts and Cases*, Copyright © 1995 by Wadsworth Publishing Company, pages 27–28

I. LICENSEE'S OBLIGATION TO SOCIETY

- a. Licensees, in the performance of their services for clients, employers, and customers, shall be cognizant that their first and foremost responsibility is to the public welfare.
- b. Licensees shall approve and seal only those design documents and surveys that conform to accepted engineering and land surveying standards and safeguard the life, health, property, and welfare of the public.
- c. Licensees shall notify their employer or client and such other authority as may be appropriate when their professional judgment is overruled under circumstances where the life, health, property, or welfare of the public is endangered.
- d. Licensees shall be objective and truthful in professional reports, statements, or testimony. They shall include all relevant and pertinent information in such reports, statements, or testimony.
- e. Licensees shall express a professional opinion publicly only when it is founded upon an adequate knowledge of the facts and a competent evaluation of the subject matter.
- f. Licensees shall issue no statements, criticisms, or arguments on technical matters which are inspired or paid for by interested parties, unless they explicitly identify the interested parties on whose behalf they are speaking and reveal any interest they have in the matters.
- g. Licensees shall not permit the use of their name or firm name by, nor associate in the business ventures with, any person or firm which is engaging in fraudulent or dishonest business or professional practices.
- h. Licensees having knowledge of possible violations of any of these *Rules of Professional Conduct* shall provide the board with the information and assistance necessary to make the final determination of such violation.

II. LICENSEE'S OBLIGATION TO EMPLOYER AND CLIENTS

- a. Licensees shall undertake assignments only when qualified by education or experience in the specific technical fields of engineering or land surveying involved.
- b. Licensees shall not affix their signatures or seals to any plans or documents dealing with subject matter in which they lack competence, nor to any such plan or document not prepared under their direct control and personal supervision.
- c. Licensees may accept assignments for coordination of an entire project, provided that each design segment is signed and sealed by the licensee responsible for preparation of that design segment.

- d. Licensees shall not reveal facts, data, or information obtained in a professional capacity without the prior consent of the client or employer except as authorized or required by law.
- e. Licensees shall not solicit or accept financial or other valuable consideration, directly or indirectly, from contractors, their agents, or other parties in connection with work for employers or clients.
- f. Licensees shall make full prior disclosures to their employers or clients of potential conflicts of interest or other circumstances which could influence or appear to influence their judgment or the quality of their service.
- g. Licensees shall not accept compensation, financial or otherwise, from more than one party for services pertaining to the same project, unless the circumstances are fully disclosed and agreed to by all interested parties.
- h. Licensees shall not solicit or accept a professional contract from a governmental body on which a principal or officer of their organization serves as a member. Conversely, licensees serving as members, advisors, or employees of a government body or department, who are the principals or employees of a private concern, shall not participate in decisions with respect to professional services offered or provided by said concern to the governmental body which they serve.

III. LICENSEE'S OBLIGATION TO OTHER LICENSEES

- a. Licensees shall not falsify or permit misrepresentation of their, or their associates', academic or professional qualifications. They shall not misrepresent or exaggerate their degree of responsibility in prior assignments nor the complexity of said assignments. Presentations incident to the solicitation of employment or business shall not misrepresent pertinent facts concerning employers, employees, associates, joint ventures, or past accomplishments.
- b. Licensees shall not offer, give, solicit, or receive, either directly or indirectly, any commission, or gift, or other valuable consideration in order to secure work, and shall not make any political contribution with the intent to influence the award of a contract by public authority.
- c. Licensees shall not attempt to injure, maliciously or falsely, directly or indirectly, the professional reputation, prospects, practice, or employment of other licensees, nor indiscriminately criticize other licensees' work.

CHEMICAL ENGINEERING

For additional information concerning heat transfer and fluid mechanics, refer to the **HEAT TRANSFER, THERMODYNAMICS**, or **FLUID MECHANICS** sections.

CHEMICAL THERMODYNAMICS

Vapor-Liquid Equilibrium

For a multi-component mixture at equilibrium

$$\hat{f}_i^V = \hat{f}_i^L, \text{ where}$$

\hat{f}_i^V = fugacity of component i in the vapor phase, and

\hat{f}_i^L = fugacity of component i in the liquid phase.

Fugacities of component i in a mixture are commonly calculated in the following ways:

For a liquid $\hat{f}_i^L = x_i \gamma_i f_i^L$, where

x_i = mole fraction of component i ,

γ_i = activity coefficient of component i , and

f_i^L = fugacity of pure liquid component i .

For a vapor $\hat{f}_i^V = y_i \hat{\Phi}_i P$, where

y_i = mole fraction of component i in the vapor,

$\hat{\Phi}_i$ = fugacity coefficient of component i in the vapor, and

P = system pressure.

The activity coefficient γ_i is a correction for liquid phase non-ideality. Many models have been proposed for γ_i such as the Van Laar model:

$$\ln \gamma_1 = A_{12} \left(1 + \frac{A_{12} x_1}{A_{21} x_2} \right)^{-2}$$

$$\ln \gamma_2 = A_{21} \left(1 + \frac{A_{21} x_2}{A_{12} x_1} \right)^{-2}, \text{ where}$$

γ_1 = activity coefficient of component 1 in a two-component system,

γ_2 = activity coefficient of component 2 in a two-component system, and

A_{12}, A_{21} = constants, typically fitted from experimental data.

The pure component fugacity is calculated as:

$$f_i^L = \Phi_i^{\text{sat}} P_i^{\text{sat}} \exp \{ v_i^L (P - P_i^{\text{sat}}) / (RT) \}, \text{ where}$$

Φ_i^{sat} = fugacity coefficient of pure saturated i ,

P_i^{sat} = saturation pressure of pure i ,

v_i^L = specific volume of pure liquid i , and

R = Ideal Gas Law Constant.

Often at system pressures close to atmospheric:

$$f_i^L \cong P_i^{\text{sat}}$$

The fugacity coefficient $\hat{\Phi}_i$ for component i in the vapor is calculated from an equation of state (e.g., Virial). Sometimes it is approximated by a pure component value from a correlation. Often at pressures close to atmospheric, $\hat{\Phi}_i = 1$. The fugacity coefficient is a correction for vapor phase non-ideality.

For sparingly soluble gases the liquid phase is sometimes represented as

$$\hat{f}_i^L = x_i k_i$$

where k_i is a constant set by experiment (Henry's constant). Sometimes other concentration units are used besides mole fraction with a corresponding change in k_i .

Chemical Reaction Equilibrium

For reaction

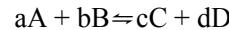

$$\Delta G^\circ = -RT \ln K_a$$

$$K_a = \frac{(\hat{a}_C)^c (\hat{a}_D)^d}{(\hat{a}_A)^a (\hat{a}_B)^b} = \prod_i (\hat{a}_i)^{v_i}, \text{ where}$$

\hat{a}_i = activity of component $i = \frac{\hat{f}_i}{f_i^\circ}$

f_i° = fugacity of pure i in its standard state

v_i = stoichiometric coefficient of component i

ΔG° = standard Gibbs energy change of reaction

K_a = chemical equilibrium constant

For mixtures of ideal gases:

f_i° = unit pressure, often 1 bar

$$\hat{f}_i = y_i P = p_i$$

where p_i = partial pressure of component i .

$$\text{Then } K_a = K_p = \frac{(p_C^c)(p_D^d)}{(p_A^a)(p_B^b)} = P^{c+d-a-b} \frac{(y_C^c)(y_D^d)}{(y_A^a)(y_B^b)}$$

For solids $\hat{a}_i = 1$

For liquids $\hat{a}_i = x_i \gamma_i$

The effect of temperature on the equilibrium constant is

$$\frac{d \ln K}{dT} = \frac{\Delta H^\circ}{RT^2}$$

where ΔH° = standard enthalpy change of reaction.

HEATS OF REACTION

For a chemical reaction the associated energy can be defined in terms of heats of formation of the individual species ($\Delta\hat{H}_f^\circ$) at the standard state

$$\left(\Delta\hat{H}_r^\circ\right) = \sum_{\text{products}} \nu_i \left(\Delta\hat{H}_f^\circ\right)_i - \sum_{\text{reactants}} \nu_i \left(\Delta\hat{H}_f^\circ\right)_i$$

The standard state is 25°C and 1 bar.

The heat of formation is defined as the enthalpy change associated with the formation of a compound from its atomic species as they normally occur in nature (i.e., O_{2(g)}, H_{2(g)}, C_(solid), etc.).

The heat of reaction for a combustion process using oxygen is also known as the heat of combustion. The principal products are CO_{2(g)} and H_{2O_(e)}.

CHEMICAL REACTION ENGINEERING

A chemical reaction may be expressed by the general equation

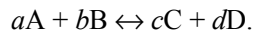

The rate of reaction of any component is defined as the moles of that component formed per unit time per unit volume.

$$-r_A = -\frac{1}{V} \frac{dN_A}{dt} \quad [\text{negative because A disappears}]$$

$$-r_A = \frac{-dC_A}{dt} \quad \text{if V is constant}$$

The rate of reaction is frequently expressed by

$$-r_A = kf_r(C_A, C_B, \dots), \text{ where}$$

k = reaction rate constant and

C_I = concentration of component I .

The Arrhenius equation gives the dependence of k on temperature

$$k = Ae^{-E_a/\bar{R}T}, \text{ where}$$

A = pre-exponential or frequency factor,

E_a = activation energy (J/mol, cal/mol),

T = temperature (K), and

\bar{R} = gas law constant = 8.314 J/(mol·K).

In the conversion of A , the fractional conversion X_A is defined as the moles of A reacted per mole of A fed.

$$X_A = (C_{A0} - C_A)/C_{A0} \quad \text{if V is constant}$$

Reaction Order

$$\text{If } -r_A = kC_A^x C_B^y$$

the reaction is x order with respect to reactant A and y order with respect to reactant B . The overall order is

$$n = x + y$$

BATCH REACTOR, CONSTANT T AND VZero-Order Reaction

$$\begin{aligned} -r_A &= kC_A^0 = k \quad (1) \\ -dC_A/dt &= k && \text{or} \\ C_A &= C_{A0} - kt \\ dX_A/dt &= k/C_{A0} && \text{or} \\ C_{A0}X_A &= kt \end{aligned}$$

First-Order Reaction

$$\begin{aligned} -r_A &= kC_A \\ -dC_A/dt &= kC_A && \text{or} \\ \ln(C_A/C_{A0}) &= -kt \\ dX_A/dt &= k(1 - X_A) && \text{or} \\ \ln(1 - X_A) &= -kt \end{aligned}$$

Second-Order Reaction

$$\begin{aligned} -r_A &= kC_A^2 \\ -dC_A/dt &= kC_A^2 && \text{or} \\ 1/C_A - 1/C_{A0} &= kt \\ dX_A/dt &= kC_{A0}(1 - X_A)^2 && \text{or} \\ X_A/[C_{A0}(1 - X_A)] &= kt \end{aligned}$$

Batch Reactor, General

For a well-mixed, constant-volume, batch reactor

$$\begin{aligned} -r_A &= dC_A/dt \\ t &= -C_{A0} \int_0^{X_A} dX_A / (-r_A) \end{aligned}$$

If the volume of the reacting mass varies with the conversion according to

$$\begin{aligned} V &= V_{X_A=0} (1 + \epsilon_A X_A) \\ \epsilon_A &= \frac{V_{X_A=1} - V_{X_A=0}}{V_{X_A=0}} \end{aligned}$$

then

$$t = -C_{A0} \int_0^{X_A} dX_A / [(1 + \epsilon_A X_A)(-r_A)]$$

FLOW REACTORS, STEADY STATE

Space-time τ is defined as the reactor volume divided by the inlet volumetric feed rate. Space-velocity SV is the reciprocal of space-time, $SV = 1/\tau$.

Plug-Flow Reactor (PFR)

$$\tau = \frac{C_{A0} V_{PFR}}{F_{A0}} = C_{A0} \int_0^{X_A} \frac{dX_A}{(-r_A)}, \text{ where}$$

F_{A0} = moles of A fed per unit time.

Continuous Stirred Tank Reactor (CSTR)

For a constant volume, well-mixed, CSTR

$$\frac{\tau}{C_{A0}} = \frac{V_{\text{CSTR}}}{F_{A0}} = \frac{X_A}{-r_A}, \text{ where}$$

$-r_A$ is evaluated at exit stream conditions.

Continuous Stirred Tank Reactors in Series

With a first-order reaction $A \rightarrow R$, no change in volume.

$$\begin{aligned} \tau_{N\text{-reactors}} &= N\tau_{\text{individual}} \\ &= \frac{N}{k} \left[\left(\frac{C_{A0}}{C_{AN}} \right)^{1/N} - 1 \right], \text{ where} \end{aligned}$$

N = number of CSTRs (equal volume) in series, and

C_{AN} = concentration of A leaving the N th CSTR.

DISTILLATION**Flash (or equilibrium) Distillation**

Component material balance:

$$Fz_F = yV + xL$$

Overall material balance:

$$F = V + L$$

Differential (Simple or Rayleigh) Distillation

$$\ln \left(\frac{W}{W_0} \right) = \int_{x_0}^x \frac{dx}{y-x}$$

When the relative volatility α is constant,

$$y = \alpha x / [1 + (\alpha - 1)x]$$

can be substituted to give

$$\ln \left(\frac{W}{W_0} \right) = \frac{1}{(\alpha - 1)} \ln \left[\frac{x(1-x_0)}{x_0(1-x)} \right] + \ln \left[\frac{1-x_0}{1-x} \right]$$

For binary system following Raoult's Law

$$\alpha = (y/x)_a / (y/x)_b = p_a / p_b, \text{ where}$$

p_i = partial pressure of component i .

Continuous Distillation (binary system)

Constant molal overflow is assumed (trays counted downward)

Overall Material Balances

Total Material:

$$F = D + B$$

Component A :

$$Fz_F = Dx_D + Bx_B$$

Operating Lines**Rectifying Section**

Total Material:

$$V_{n+1} = L_n + D$$

Component A :

$$V_{n+1}y_{n+1} = L_nx_n + Dx_D$$

$$y_{n+1} = [L_n / (L_n + D)] x_n + Dx_D / (L_n + D)$$

Stripping Section

Total Material:

$$L_m = V_{m+1} + B$$

Component A :

$$L_mx_m = V_{m+1}y_{m+1} + Bx_B$$

$$y_{m+1} = [L_m / (L_m - B)] x_m - Bx_B / (L_m - B)$$

Reflux Ratio

Ratio of reflux to overhead product

$$R_D = L/D = (V - D)/D$$

Minimum reflux ratio is defined as that value which results in an infinite number of contact stages. For a binary system the equation of the operating line is

$$y = \frac{R_{\min}}{R_{\min} + 1} x + \frac{x_D}{R_{\min} + 1}$$

Feed Condition Line

slope = $q/(q - 1)$, where

$$q = \frac{\text{heat to convert one mol of feed to saturated vapor}}{\text{molar heat of vaporization}}$$

Murphree Plate Efficiency

$$E_{ME} = (y_n - y_{n+1}) / (y_n^* - y_{n+1}), \text{ where}$$

y = concentration of vapor above plate n ,

y_{n+1} = concentration of vapor entering from plate below n , and

y_n^* = concentration of vapor in equilibrium with liquid leaving plate n .

A similar expression can be written for the stripping section by replacing n with m .

Definitions:

- α = relative volatility,
- B = molar bottoms-product rate,
- D = molar overhead-product rate,
- F = molar feed rate,
- L = molar liquid downflow rate,
- R_D = ratio of reflux to overhead product,
- V = molar vapor upflow rate,
- W = weight in still pot,
- x = mole fraction of the more volatile component in the liquid phase, and
- y = mole fraction of the more volatile component in the vapor phase.

Subscripts

- B = bottoms product,
- D = overhead product,
- F = feed,
- m = any plate in stripping section of column,
- $m+1$ = plate below plate m ,
- n = any plate in rectifying section of column,
- $n+1$ = plate below plate n , and
- o = original charge in still pot.

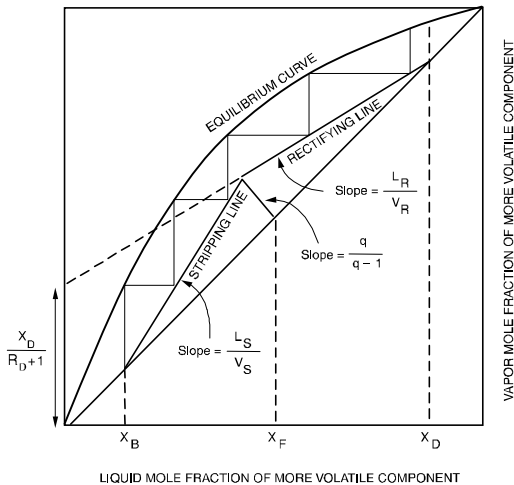
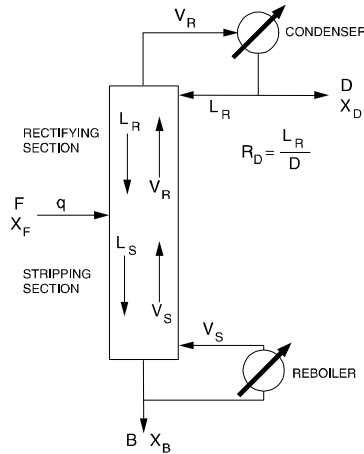

MASS TRANSFER

Diffusion

Molecular Diffusion

$$\text{Gas: } \frac{N_A}{A} = \frac{p_A}{P} \left(\frac{N_A}{A} + \frac{N_B}{A} \right) - \frac{D_m}{RT} \frac{\partial p_A}{\partial z}$$

$$\text{Liquid: } \frac{N_A}{A} = x_A \left(\frac{N_A}{A} + \frac{N_B}{A} \right) - CD_m \frac{\partial x_A}{\partial z}$$

in which $(p_B)_{lm}$ is the log mean of p_{B2} and p_{B1} ,

Unidirectional Diffusion of a Gas A Through a Second Stagnant Gas B ($N_b = 0$)

$$\frac{N_A}{A} = \frac{D_m P}{RT(p_B)_{lm}} \times \frac{(p_{A2} - p_{A1})}{z_2 - z_1}$$

in which $(p_B)_{lm}$ is the log mean of p_{B2} and p_{B1} ,

N_I = diffusive flow of component I through area A , in z direction, and

D_m = mass diffusivity.

EQUIMOLAR COUNTER-DIFFUSION (GASES)

($N_B = -N_A$)

$$N_A/A = D_m / (\bar{R}T) \times [(p_{A1} - p_{A2}) / (z_2 - z_1)]$$

Unsteady State Diffusion in a Gas

$$\partial p_A / \partial t = D_m (\partial^2 p_A / \partial z^2)$$

CONVECTION

Two-Film Theory (for Equimolar Counter-Diffusion)

$$\begin{aligned} N_A/A &= k'_G (p_{AG} - p_{Ai}) \\ &= k'_L (C_{Ai} - C_{AL}) \\ &= K'_G (p_{AG} - p_A^*) \\ &= K'_L (C_A^* - C_{AL}) \end{aligned}$$

where p_A^* is partial pressure in equilibrium with C_{AL} , and

C_A^* = concentration in equilibrium with p_{AG} .

Overall Coefficients

$$1/K'_G = 1/k'_G + H/k'_L$$

$$1/K'_L = 1/Hk'_G + 1/k'_L$$

Dimensionless Group Equation (Sherwood)

For the turbulent flow inside a tube the Sherwood number

$$\left(\frac{k_m D}{D_m} \right) \text{ is given by: } \left(\frac{k_m D}{D_m} \right) = 0.023 \left(\frac{D \nu \rho}{\mu} \right)^{0.8} \left(\frac{\mu}{\rho D_m} \right)^{1/3}$$

where,

D = inside diameter,

D_m = diffusion coefficient,

V = average velocity in the tube,

ρ = fluid density, and

μ = fluid viscosity.

CIVIL ENGINEERING

GEOTECHNICAL

Definitions

c = cohesion

c_c = coefficient of curvature or gradation
 = $(D_{30})^2 / [(D_{60})(D_{10})]$, where

D_{10}, D_{30}, D_{60} = particle diameter corresponding to 10%, 30%, and 60% on grain-size curve.

c_u = uniformity coefficient = D_{60}/D_{10}

e = void ratio = V_v/V_s , where

V_v = volume of voids, and

V_s = volume of the solids.

K = coefficient of permeability = hydraulic conductivity
 = $Q/(iA)$ (from Darcy's equation), where

Q = discharge,

i = hydraulic gradient = dH/dx ,

H = hydraulic head,

A = cross-sectional area.

q_u = unconfined compressive strength = $2c$

w = water content (%) = $(W_w/W_s) \times 100$, where

W_w = weight of water, and

W_s = weight of solids.

C_c = compression index = $\Delta e / \Delta \log p$
 = $(e_1 - e_2) / (\log p_2 - \log p_1)$, where

e_1 and e_2 = void ratio, and

p_1 and p_2 = pressure.

D_d = relative density (%)

= $[(e_{\max} - e) / (e_{\max} - e_{\min})] \times 100$

= $[(1/\gamma_{\min} - 1/\gamma_d) / (1/\gamma_{\min} - 1/\gamma_{\max})] \times 100$, where

e_{\max} and e_{\min} = maximum and minimum void ratio, and

γ_{\max} and γ_{\min} = maximum and minimum unit dry weight.

G = specific gravity = $W_s / (V_s \gamma_w)$, where

γ_w = unit weight of water.

ΔH = settlement = $H [C_c / (1 + e_i)] \log [(p_i + \Delta p) / p_i]$
 = $H \Delta e / (1 + e_i)$, where

H = thickness,

Δe = change in void ratio, and

p = pressure.

PI = plasticity index = $LL - PL$, where

LL = liquid limit, and

PL = plasticity limit.

S = degree of saturation (%) = $(V_w / V_v) \times 100$, where

V_w = volume of free water, and

V_v = volume of voids.

Q = $KH(N_f/N_d)$ (for flow nets, Q per unit width), where

K = coefficient permeability,

H = total hydraulic head (potential),

N_f = number of flow tubes, and

N_d = number of potential drips.

γ = total unit weight of soil = W/V

γ_d = dry unit weight of soil = W_s/V

= $G\gamma_w / (1 + e) = \gamma / (1 + w)$, where

G = specific gravity of particles

$G_w = Se$, where

s = degree of saturation.

e = void ratio

γ_s = unit of weight of solids = W_s / V_s

η = porosity = $V_v / V = e / (1 + e)$

τ = general shear strength = $c + \sigma \tan \phi$, where

ϕ = angle of internal friction,

σ = normal stress = P/A ,

P = force, and

A = area.

K_a = coefficient of active earth pressure
 = $\tan^2(45 - \phi/2)$

K_p = coefficient of passive earth pressure
 = $\tan^2(45 + \phi/2)$

P_a = active resultant force = $0.5\gamma H^2 K_a$, where

H = height of wall.

q_{ult} = bearing capacity equation

= $cN_c + \gamma D_f N_q + 0.5\gamma B N_\gamma$, where

$N_c, N_q,$ and N_γ = bearing capacity,

B = width of strip footing, and

D_f = depth of footing below surface.

FS = factor of safety (slope stability)

= $\frac{cL + W \cos \alpha \tan \phi}{W \sin \alpha}$, where

L = length of slip plane,

α = slope of slip plane,

ϕ = angle of friction, and

W = total weight of soil above slip plane.

C_v = coefficient of consolidation = TH^2/t , where

T = time factor,

H = compression zone, and

t = consolidation time.

C_c = compression index for ordinary clay
 = $0.009 (LL - 10)$

σ' = effective stress = $\sigma - u$, where

σ = normal stress, and

u = pore water pressure.

UNIFIED SOIL CLASSIFICATION SYSTEM (ASTM D-2487)

Major Divisions		Group Symbols	Typical Names	Laboratory Classification Criteria		
Coarse-grained soils (More than half of material is larger than No. 200 sieve size)	Gravels (More than half of coarse fraction is larger than No. 4 sieve size)	GW	Well-graded gravels, gravel-sand mixtures, little or no fines	$C_u = \frac{D_{60}}{D_{10}}$ greater than 4; $C_c = \frac{(D_{30})^2}{D_{10} \times D_{60}}$ between 1 and 3		
				GP	Poorly graded gravels, gravel-sand mixtures, little or no fines	Not meeting all gradation requirements for GW
		Sands (More than half of coarse fraction is smaller than No. 4 sieve size)	GM ^a	d	Silty gravels, gravel-sand-silt mixtures	Atterberg limits below "A" line or PI less than 4
	u			Above "A" line with PI between 4 and 7 are <i>borderline</i> cases requiring use of dual symbols		
	GC		Clayey gravels, gravel-sand-clay mixtures	Atterberg limits below "A" line with PI greater than 7		
	Sands with fines (Appreciable amount of fines)	SW	Well-graded sands, gravelly sands, little or no fines	$C_u = \frac{D_{60}}{D_{10}}$ greater than 6; $C_c = \frac{(D_{30})^2}{D_{10} \times D_{60}}$ between 1 and 3		
				SP	Poorly graded sand, gravelly sands, little or no fines	Not meeting all gradation requirements for SW
		SM ^a	d	Silty sands, sand-silt mixtures	Atterberg limits above "A" line or PI less than 4	
			u		Limits plotting in hatched zone with PI between 4 and 7 are <i>borderline</i> cases requiring use of dual symbols	
	SC	Clayey sands, sand-clay mixtures	Atterberg limits above "A" line with PI greater than 7			
Fine-grained soils (More than half material is smaller than No. 200 sieve)	Sils and clays (Liquid limit less than 50)	ML	Inorganic silts and very fine sands, rock flour, silty or clayey fine sands, or clayey silts with slight plasticity	<p style="text-align: center;">PLASTICITY CHART</p>		
		CL	Inorganic clays of low to medium plasticity, gravelly clays, sandy clays, silty clays, lean clays			
		OL	Organic silts and organic silty clays of low plasticity			
	Sils and clays (Liquid limit greater than 50)	MH	Inorganic silts, micaceous or diatomaceous fine sandy or silty soils, elastic silts			
		CH	Inorganic clays of high plasticity, fat clays			
		OH	Organic clays of medium to high plasticity, organic silts			
	Highly organic soils	Pt	Peat and other highly organic soils			

^a Division of GM and SM groups into subdivisions of d and u are for roads and airfields only. Subdivision is based on Atterberg limits; suffix d used when LL is 28 or less and the PI is 6 or less; the suffix u used when LL is greater than 28.

^b Borderline classification, used for soils possessing characteristics of two groups, are designated by combinations of group symbols. For example GW-GC, well-graded gravel-sand mixture with clay binder.

STRUCTURAL ANALYSIS

Influence Lines

An influence diagram shows the variation of a function (reaction, shear, bending moment) as a single unit load moves across the structure. An influence line is used to (1) determine the position of load where a maximum quantity will occur and (2) determine the maximum value of the quantity.

Deflection of Trusses and Frames

Principle of virtual work as applied to deflection of trusses:

$$\Delta = \Sigma F_Q \delta L, \text{ where}$$

for temperature: $\delta L = \alpha L(\Delta T)$

and for load: $\delta L = F_p L/AE$

Frames:

$$\Delta = \Sigma \{ \int m [M/(EI)] dx \}, \text{ where}$$

F_Q = member force due to unit loads,

F_p = member force due to external load,

M = bending moment due to external loads, and

m = bending moment due to unit load.

BEAM FIXED-END MOMENT FORMULAS

$$FEM_{AB} = -\frac{Pab^2}{L^2}$$

$$FEM_{BA} = +\frac{Pa^2b}{L^2}$$

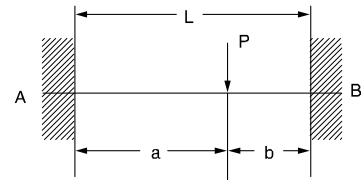

$$FEM_{AB} = -\frac{w_o L^2}{12}$$

$$FEM_{BA} = +\frac{w_o L^2}{12}$$

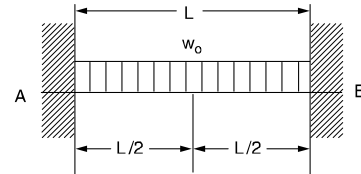

$$FEM_{AB} = -\frac{w_o L^2}{30}$$

$$FEM_{BA} = +\frac{w_o L^2}{20}$$

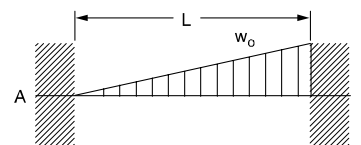

REINFORCED CONCRETE DESIGN

Ultimate Strength Design

ASTM Standard Reinforcing Bars			
Bar Size No.	Nominal Diameter in.	Nominal Area in. ²	Nominal Weight lb/ft
3	0.375	0.11	0.376
4	0.500	0.20	0.668
5	0.625	0.31	1.043
6	0.750	0.44	1.502
7	0.875	0.60	2.044
8	1.000	0.79	2.670
9	1.128	1.00	3.400
10	1.270	1.27	4.303
11	1.410	1.56	5.313
14	1.693	2.25	7.650
18	2.257	4.00	13.600

Strength Reduction Factors	
Type of Stress	ϕ
Flexure	0.90
Axial Tension	0.90
Shear	0.85
Torsion	0.85
Axial Compression With Spiral Reinforcement	0.75
Axial Compression With Tied Reinforcement	0.70
Bearing on Concrete	0.70

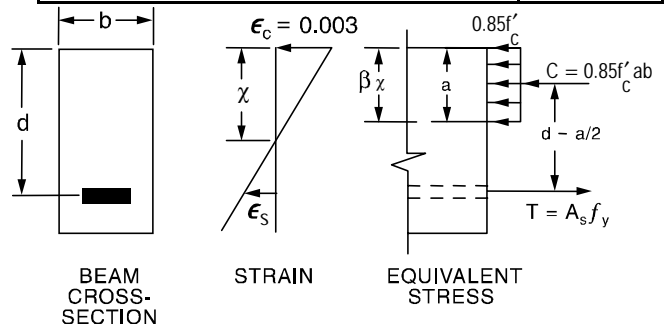

Definitions

- A_g = gross cross-sectional area,
 A_s = area of tension steel,
 A_v = area of shear reinforcement within a distance s along a member,
 b = width of section,
 b_w = width of web,
 β = ratio of depth of rectangular stress block to the depth to the neutral axis,

$$= 0.85 \geq 0.85 - 0.05 \left(\frac{f'_c - 4,000}{1,000} \right) \geq 0.65$$

 d = effective depth,
 E = modulus of elasticity of concrete,
 f'_c = compressive stress of concrete,
 f_y = yield stress of steel,
 M_n = nominal moment (service moment * ultimate load factors),
 M_u = factored moment (nominal moment * strength reduction factor),
 P_n = nominal axial load (with minimum eccentricity),
 P_o = nominal P_n for axially loaded column,
 ρ = reinforcement ratio, tension steel,
 ρ_b = reinforcement ratio for balanced strain condition,
 s = spacing of shear reinforcement,
 V_c = nominal concrete shear strength,
 V_s = nominal shear strength provided by reinforcement, and
 V_u = factored shear force.

Reinforcement Limits

$$\rho = A_s / (bd)$$

$$\rho_{\min} \leq \rho \leq 0.75\rho_b$$

$$\rho_{\min} \geq \frac{3\sqrt{f'_c}}{f_y} \quad \text{or} \quad \frac{200}{f_y}$$

$$\rho_b = \frac{0.85\beta f'_c}{f_y} \left(\frac{87,000}{87,000 + f_y} \right)$$

Moment Design

$$\phi M_n = \phi 0.85f'_c ab (d - a/2)$$

$$= \phi A_s f_y (d - a/2)$$

$$a = \frac{A_s f_y}{0.85 f'_c b}$$

$$M_u = 1.4M_{\text{Dead}} + 1.7M_{\text{Live}}$$

$$\phi M_n \geq M_u$$

Shear Design

$$\phi (V_c + V_s) \geq V_u$$

$$V_u = 1.4V_{\text{Dead}} + 1.7V_{\text{Live}}$$

$$V_c = 2\sqrt{f'_c} bd$$

$$V_s = A_v f_y d / s$$

$$V_{s(\max)} = 8\sqrt{f'_c} bd$$

Minimum Shear Reinforcement

$$A_v = 50bs/f_y, \text{ when}$$

$$V_u > \phi V_c / 2$$

Maximum Spacing for Stirrups

$$\text{If } V_s \leq 4\sqrt{f'_c}$$

$$s_{\max} = \min \left\{ \begin{array}{l} 24 \text{ inches} \\ d/2 \end{array} \right\}$$

$$\text{If } V_s > 4\sqrt{f'_c} bd$$

$$s_{\max} = \min \left\{ \begin{array}{l} 12 \text{ inches} \\ d/4 \end{array} \right\}$$

T-Beams

Effective Flange Width

$$b_e = \min \left\{ \begin{array}{l} 1/4 \times \text{span length} \\ b_w + 16 \times \text{slab depth} \\ b_w + \text{clear span between beams} \end{array} \right.$$

Moment Capacity

($a >$ slab depth)

$$\phi M_n = \phi [0.85f'_c h_f (b_e - b_w)(d - h_f/2) + 0.85f'_c ab_w (d - a/2)]$$

where

h_f = slab depth, and

b_w = web width.

Columns

$$\phi P_n > P_u$$

$$P_n = 0.8P_o \quad (\text{tied})$$

$$P_n = 0.85P_o \quad (\text{spiral})$$

$$P_o = 0.85f'_c A_{\text{concrete}} + f_y A_s$$

$$A_{\text{concrete}} = A_g - A_s$$

Reinforcement Ratio

$$\rho_g = A_s / A_g$$

$$0.01 \leq \rho_g \leq 0.08$$

STEEL DESIGN**LOAD COMBINATIONS (LRFD)**

Floor systems: 1.4D
1.2D + 1.6L

Roof systems: 1.2D + 1.6(L_r or S or R) + 0.8W
1.2D + 0.5(L_r or S or R) + 1.3W
0.9D ± 1.3W

where: D = dead load due to the weight of the structure and permanent features

L = live load due to occupancy and moveable equipment

L_r = roof live load

S = snow load

R = load due to initial rainwater (excluding ponding) or ice

W = wind load

TENSION MEMBERS: flat plates, angles (bolted or welded)

Gross area: $A_g = b_g t$ (use tabulated value for angles)

Net area: $A_n = (b_g - \sum D_h + \frac{s^2}{4g}) t$
across critical chain of holes

where: b_g = gross width

t = thickness

s = longitudinal center-to-center spacing (pitch) of two consecutive holes

g = transverse center-to-center spacing (gage) between fastener gage lines

D_h = bolt-hole diameter

Effective area (bolted members):

$$A_e = UA_n \begin{cases} U = 1.0 \text{ (flat bars)} \\ U = 0.85 \text{ (angles with } \geq 3 \text{ bolts in line)} \\ U = 0.75 \text{ (angles with 2 bolts in line)} \end{cases}$$

Effective area (welded members):

$$A_e = UA_g \begin{cases} U = 1.0 \text{ (flat bars, } L \geq 2w) \\ U = 0.87 \text{ (flat bars, } 2w > L \geq 1.5w) \\ U = 0.75 \text{ (flat bars, } 1.5w > L \geq w) \\ U = 0.85 \text{ (angles)} \end{cases}$$

LRFD

Yielding: $\phi T_n = \phi_y A_g F_y = 0.9 A_g F_y$

Fracture: $\phi T_n = \phi_f A_e F_u = 0.75 A_e F_u$

Block shear rupture (bolted tension members):

A_{gt} = gross tension area

A_{gv} = gross shear area

A_{nt} = net tension area

A_{nv} = net shear area

When $F_u A_{nt} \geq 0.6 F_u A_{nv}$:

$$\phi R_n = 0.75 [0.6 F_y A_{gv} + F_u A_{nt}]$$

When $F_u A_{nt} < 0.6 F_u A_{nv}$:

$$\phi R_n = 0.75 [0.6 F_u A_{nv} + F_y A_{gt}]$$

ASD

Yielding: $T_a = A_g F_t = A_g (0.6 F_y)$

Fracture: $T_a = A_e F_t = A_e (0.5 F_u)$

Block shear rupture (bolted tension members):

$$T_a = (0.30 F_u) A_{nv} + (0.5 F_u) A_{nt}$$

A_{nt} = net tension area

A_{nv} = net shear area

BEAMS: homogeneous beams, flexure about x-axis

Flexure – local buckling:

No local buckling if section is **compact**: $\frac{b_f}{2t_f} \leq \frac{65}{\sqrt{F_y}}$ **and** $\frac{h}{t_w} \leq \frac{640}{\sqrt{F_y}}$

where: For **rolled** sections, use tabulated values of $\frac{b_f}{2t_f}$ and $\frac{h}{t_w}$

For **built-up** sections, h is clear distance between flanges

For $F_y \leq 50$ ksi, all **rolled shapes** except $W6 \times 19$ are compact.

Flexure – lateral-torsional buckling: $L_b =$ unbraced length

LRFD—compact rolled shapes

$$L_p = \frac{300 r_y}{\sqrt{F_y}}$$

$$L_r = \frac{r_y X_1}{F_L} \sqrt{1 + \sqrt{1 + X_2 F_L^2}}$$

where: $F_L = F_y - 10$ ksi

$$\left. \begin{aligned} X_1 &= \frac{\pi}{S_x} \sqrt{\frac{EGJ A}{2}} \\ X_2 &= 4 \frac{C_w}{I_y} \left(\frac{S_x}{GJ} \right)^2 \end{aligned} \right\} \begin{array}{l} \text{Tabulated in} \\ \text{Part 1 of} \\ \text{AISC Manual} \end{array}$$

$$\phi = 0.90$$

$$\phi M_p = \phi F_y Z_x$$

$$\phi M_r = \phi F_y S_x$$

$$C_b = \frac{12.5 M_{\max}}{2.5 M_{\max} + 3 M_A + 4 M_B + 3 M_C}$$

$$L_b \leq L_p: \quad \phi M_n = \phi M_p$$

$$L_p < L_b \leq L_r:$$

$$\begin{aligned} \phi M_n &= C_b \left[\phi M_p - (\phi M_p - \phi M_r) \left(\frac{L_b - L_p}{L_r - L_p} \right) \right] \\ &= C_b [\phi M_p - BF (L_b - L_p)] \leq \phi M_p \end{aligned}$$

See *Load Factor Design Selection Table* for BF

$$L_b > L_r:$$

$$\phi M_n = \frac{\phi C_b S_x X_1 \sqrt{2}}{L_b / r_y} \sqrt{1 + \frac{X_1^2 X_2}{2(L_b / r_y)^2}} \leq \phi M_p$$

See *Beam Design Moments* curves

ASD—compact rolled shapes

$$L_c = \frac{76 b_f}{\sqrt{F_y}} \text{ or } \frac{20,000}{(d / A_f) F_y} \text{ use smaller}$$

$$C_b = 1.75 + 1.05(M_1 / M_2) + 0.3(M_1 / M_2)^2 \leq 2.3$$

M_1 is smaller end moment

M_1 / M_2 is positive for reverse curvature

$$M_a = S F_b$$

$$L_b \leq L_c: F_b = 0.66 F_y$$

$$L_b > L_c:$$

$$F_b = \left[\frac{2}{3} - \frac{F_y (L_b / r_T)^2}{1,530,000 C_b} \right] \leq 0.6 F_y \quad (F1-6)$$

$$F_b = \frac{170,000 C_b}{(L_b / r_T)^2} \leq 0.6 F_y \quad (F1-7)$$

$$F_b = \frac{12,000 C_b}{L_b d / A_f} \leq 0.6 F_y \quad (F1-8)$$

$$\text{For: } \sqrt{\frac{102,000 C_b}{F_y}} < \frac{L_b}{r_T} \leq \sqrt{\frac{510,000 C_b}{F_y}} :$$

Use larger of (F1-6) and (F1-8)

$$\text{For: } \frac{L_b}{r_T} > \sqrt{\frac{510,000 C_b}{F_y}} :$$

Use larger of (F1-7) and (F1-8)

See *Allowable Moments in Beams* curves

Shear – unstiffened beams:**LRFD**

$$\phi = 0.90$$

$$A_w = d t_w$$

$$\frac{h}{t_w} \leq \frac{418}{\sqrt{F_y}}$$

$$\phi V_n = \phi (0.6 F_y) A_w$$

$$\frac{418}{\sqrt{F_y}} < \frac{h}{t_w} \leq \frac{523}{\sqrt{F_y}}$$

$$\phi V_n = \phi (0.6 F_y) A_w \left[\frac{418}{(h/t_w) \sqrt{F_y}} \right]$$

$$\frac{523}{\sqrt{F_y}} < \frac{h}{t_w} \leq 260$$

$$\phi V_n = \phi (0.6 F_y) A_w \left[\frac{220,000}{(h/t_w)^2 F_y} \right]$$

ASD

$$\text{For } \frac{h}{t_w} \leq \frac{380}{\sqrt{F_y}}: F_v = 0.40 F_y$$

$$\text{For } \frac{h}{t_w} > \frac{380}{\sqrt{F_y}}: F_v = \frac{F_y}{2.89} (C_v) \leq 0.4 F_y$$

where for unstiffened beams:

$$k_v = 5.34$$

$$C_v = \frac{190}{h/t_w} \sqrt{\frac{k_v}{F_y}} = \frac{439}{(h/t_w) \sqrt{F_y}}$$

COLUMNS**Column effective length KL :**

AISC Table C-C2.1 (LRFD and ASD)–Effective Length Factors (K) for Columns

AISC Figure C-C2.2 (LRFD and ASD)–Alignment Chart for Effective Length of Columns in Frames

Column capacities**LRFD**

Column slenderness parameter:

$$\lambda_c = \left(\frac{KL}{r} \right)_{\max} \left(\frac{1}{\pi} \sqrt{\frac{F_y}{E}} \right)$$

Nominal capacity of axially loaded columns (doubly symmetric section, no local buckling):

$$\phi = 0.85$$

$$\lambda_c \leq 1.5: \quad \phi F_{cr} = \phi \left(0.658^{\lambda_c^2} \right) F_y$$

$$\lambda_c > 1.5: \quad \phi F_{cr} = \phi \left[\frac{0.877}{\lambda_c^2} \right] F_y$$

See Table 3-50: Design Stress for Compression

Members ($F_y = 50$ ksi, $\phi = 0.85$)

ASD

Column slenderness parameter:

$$C_c = \sqrt{\frac{2\pi^2 E}{F_y}}$$

Allowable stress for axially loaded columns (doubly symmetric section, no local buckling):

$$\text{When } \left(\frac{KL}{r} \right)_{\max} \leq C_c$$

$$F_a = \frac{\left[1 - \frac{(KL/r)^2}{2C_c^2} \right] F_y}{\frac{5}{3} + \frac{3(KL/r)}{8C_c} - \frac{(KL/r)^3}{8C_c^3}}$$

$$\text{When } \left(\frac{KL}{r} \right)_{\max} > C_c: \quad F_a = \frac{12\pi^2 E}{23(KL/r)^2}$$

See Table C-50: Allowable Stress for Compression

Members ($F_y = 50$ ksi)

BEAM-COLUMNS: sidesway prevented, x-axis bending, transverse loading between supports, ends unrestrained against rotation in the plane of bending

LRFD

$$\frac{P_u}{\phi P_n} \geq 0.2: \quad \frac{P_u}{\phi P_n} + \frac{8 M_u}{9 \phi M_n} \leq 1.0$$

$$\frac{P_u}{\phi P_n} < 0.2: \quad \frac{P_u}{2 \phi P_n} + \frac{M_u}{\phi M_n} \leq 1.0$$

where:

$$M_u = B_1 M_{nt}$$

$$B_1 = \frac{C_m}{1 - \frac{P_u}{P_{el}}} \geq 1.0$$

$C_m = 1.0$ for conditions stated above

$$P_{el} = \left(\frac{\pi^2 E I_x}{(KL_x)^2} \right) \text{ x-axis bending}$$

ASD

$$\frac{f_a}{F_a} > 0.15: \quad \frac{f_a}{F_a} + \frac{C_m f_b}{\left(1 - \frac{f_a}{F'_e}\right) F_b} \leq 1.0$$

$$\frac{f_a}{F_a} \leq 0.15: \quad \frac{f_a}{F_a} + \frac{f_b}{F_b} \leq 1.0$$

where:

$C_m = 1.0$ for conditions stated above

$$F'_e = \frac{12 \pi^2 E}{23 (KL_x/r_x)^2} \text{ x-axis bending}$$

BOLTED CONNECTIONS: A_B = nominal bolt area, d = nominal bolt diameter, t = plate thickness

Basic bolt strengths: A325-N and A325-SC bolts, S = spacing $\geq 3d$, L_e = end distance $\geq 1.5d$

LRFD—factored loads

Design strength (kips/bolt):

Tension: $\phi R_t = \phi F_t A_b$

Shear: $\phi R_v = \phi F_v A_b$

Bearing: $\phi r_b = \phi 2.4 d F_u$ (kips/inch)
 $\phi R_b = \phi 2.4 dt F_u$

Slip resistance (kips/bolt): ϕR_{str}

Bolt strength	Bolt size		
	3/4"	7/8"	1"
ϕR_t	29.8	40.6	53.0
ϕR_v (A325-N)	15.9	21.6	28.3
ϕR_{str} (A325-SC)	10.4	14.5	19.0
ϕr_b ($F_u = 58$)	78.3	91.4	104
ϕr_b ($F_u = 65$)	87.8	102	117

ϕR_v and ϕR_{str} values are single shear

ASD

Design strength (kips/bolt):

Tension: $R_t = F_t A_b$

Shear: $R_v = F_v A_b$

Bearing: $r_b = 1.2 F_u d$ (kips/inch)
 $R_b = 1.2 F_u dt$

Bolt strength	Bolt size		
	3/4"	7/8"	1"
R_t	19.4	26.5	34.6
R_v (A325-N)	9.3	12.6	16.5
R_v (A325-SC)	6.63	9.02	11.8
r_b ($F_u = 58$)	52.2	60.9	69.6
r_b ($F_u = 65$)	58.5	68.3	78.0

R_v values are single shear

Reduced bolt strength: A325-N bolts, $L_e = \text{end distance} < 1.5d$, $S = \text{spacing} < 3d$

Minimum permitted spacing and end distance:

$$S \text{ (minimum)} = 2\frac{2}{3} d$$

L_e (minimum):

Bolt diameter	3/4"	7/8"	1"
L_e (minimum)	1 1/4"	1 1/2" *	1 3/4" *

*1 1/4" at ends of beam connection angles and shear end plates

LRFD

$$\phi = 0.75$$

$$L_e < 1.5d: \quad \phi R_n = \phi L_e F_u t$$

$$s < 3d: \quad \phi R_n = \phi \left(s - \frac{d}{2} \right) F_u t$$

ASD

$$L_e < 1.5d: \quad R_b = \frac{L_e F_u t}{2}$$

$$s < 3d: \quad R_b = \frac{\left(s - \frac{d}{2} \right) F_u t}{2}$$

LOAD FACTOR DESIGN SELECTION TABLE											Z_x
For shapes used as beams											
$\phi_b = 0.90$											
<i>F_y = 36 ksi</i>					<i>Z_x</i>	Shape	<i>F_y = 50 ksi</i>				
<i>BF</i>	<i>L_r</i>	<i>L_p</i>	$\phi_b M_r$	$\phi_b M_p$			$\phi_b M_p$	$\phi_b M_r$	<i>L_p</i>	<i>L_r</i>	<i>BF</i>
Kips	Ft	Ft	Kip-ft	Kip-ft	In. ³	Kip-ft	Kip-ft	Ft	Ft	Kips	
12.7	16.6	5.6	222	362	134	W24x55	503	342	4.7	12.9	19.6
8.08	23.2	7.0	228	359	133	W18x65	499	351	6.0	17.1	13.3
2.90	56.4	12.8	230	356	132	W12x87	495	354	10.9	38.4	5.12
2.00	77.4	11.0	218	351	130	W10x100	488	336	9.4	50.8	3.66
5.57	32.3	10.3	228	351	130	W16x67	488	351	8.7	23.8	9.02
11.3	17.3	5.6	216	348	129	W21x57	484	333	4.8	13.1	18.0
4.10	40.0	10.3	218	340	126	W14x74	473	336	8.8	28.0	7.12
7.91	22.4	7.0	211	332	123	W18x60	461	324	6.0	16.7	12.8
2.88	51.8	12.7	209	321	119	W12x79	446	321	10.8	35.7	5.03
4.05	37.3	10.3	201	311	115	W14x68	431	309	8.7	26.4	6.91
1.97	68.4	11.0	192	305	113	W10x88	424	296	9.3	45.1	3.58
7.65	21.4	7.0	192	302	112	W18x55	420	295	5.9	16.1	12.2
10.5	16.2	5.4	184	297	110	W21x50	413	284	4.6	12.5	16.4
2.87	48.2	12.7	190	292	108	W12x72	405	292	10.7	33.6	4.93
6.43	22.8	6.7	180	284	105	W16x57	394	277	5.7	16.6	10.7
3.91	34.7	10.2	180	275	102	W14x61	383	277	8.7	24.9	6.51
7.31	20.5	6.9	173	273	101	W18x50	379	267	5.8	15.6	11.5
1.95	60.1	10.8	168	264	97.6	W10x77	366	258	9.2	39.9	3.53
2.80	44.7	12.6	171	261	96.8	W12x65 ^b	358	264	11.8	31.7	4.72
9.68	15.4	5.3	159	258	95.4	W21x44	358	245	4.5	12.0	14.9
6.18	21.3	6.6	158	248	92.0	W16x50	345	243	5.6	15.8	10.1
8.13	16.6	5.4	154	245	90.7	W18x46	340	236	4.6	12.6	13.0
4.17	28.0	8.0	152	235	87.1	W14x53	327	233	6.8	20.1	7.02
2.91	38.4	10.5	152	233	86.4	W12x58	324	234	8.9	27.0	4.96
1.93	53.7	10.8	148	230	85.3	W10x68	320	227	9.2	36.0	3.46
5.91	20.2	6.5	142	222	82.3	W16x45	309	218	5.6	15.2	9.43
7.51	15.7	5.3	133	212	78.4	W18x40	294	205	4.5	12.1	11.7
4.06	26.3	8.0	137	212	78.4	W14x48	294	211	6.8	19.2	6.70
2.85	35.8	10.3	138	210	77.9	W12x53	292	212	8.8	25.6	4.77
1.91	48.1	10.7	130	201	74.6	W10x60	280	200	9.1	32.6	3.38
5.54	19.3	6.5	126	197	72.9	W16x40	273	194	5.6	14.7	8.67
3.06	30.8	8.2	126	195	72.4	W12x50	272	194	6.9	21.7	5.25
1.30	64.0	8.8	118	190	70.2	W8x67	263	181	7.5	41.9	2.38
3.91	24.7	7.9	122	188	69.6	W14x43	261	188	6.7	18.2	6.32
1.89	43.9	10.7	117	180	66.6	W10x54	250	180	9.1	30.2	3.30
6.95	14.8	5.1	112	180	66.5	W18x35	249	173	4.3	11.5	10.7
3.01	28.5	8.1	113	175	64.7	W12x45	243	174	6.9	20.3	5.07
5.23	18.3	6.3	110	173	64.0	W16x36	240	170	5.4	14.1	8.08
4.41	20.0	6.5	106	166	61.5	W14x38	231	164	5.5	14.9	7.07
1.88	40.7	10.6	106	163	60.4	W10x49	227	164	9.0	28.3	3.25
1.27	56.0	8.8	101	161	59.8	W8x58	224	156	7.4	36.8	2.32
2.92	26.5	8.0	101	155	57.5	W12x40	216	156	6.8	19.3	4.82
1.96	35.1	8.4	95.7	148	54.9	W10x45	206	147	7.1	24.1	3.45

^b indicates noncompact shape; *F_y* = 50 ksi

BEAM DESIGN MOMENTS ($\phi = 0.9$, $C_b = 1$, $F_y = 50$ ksi)

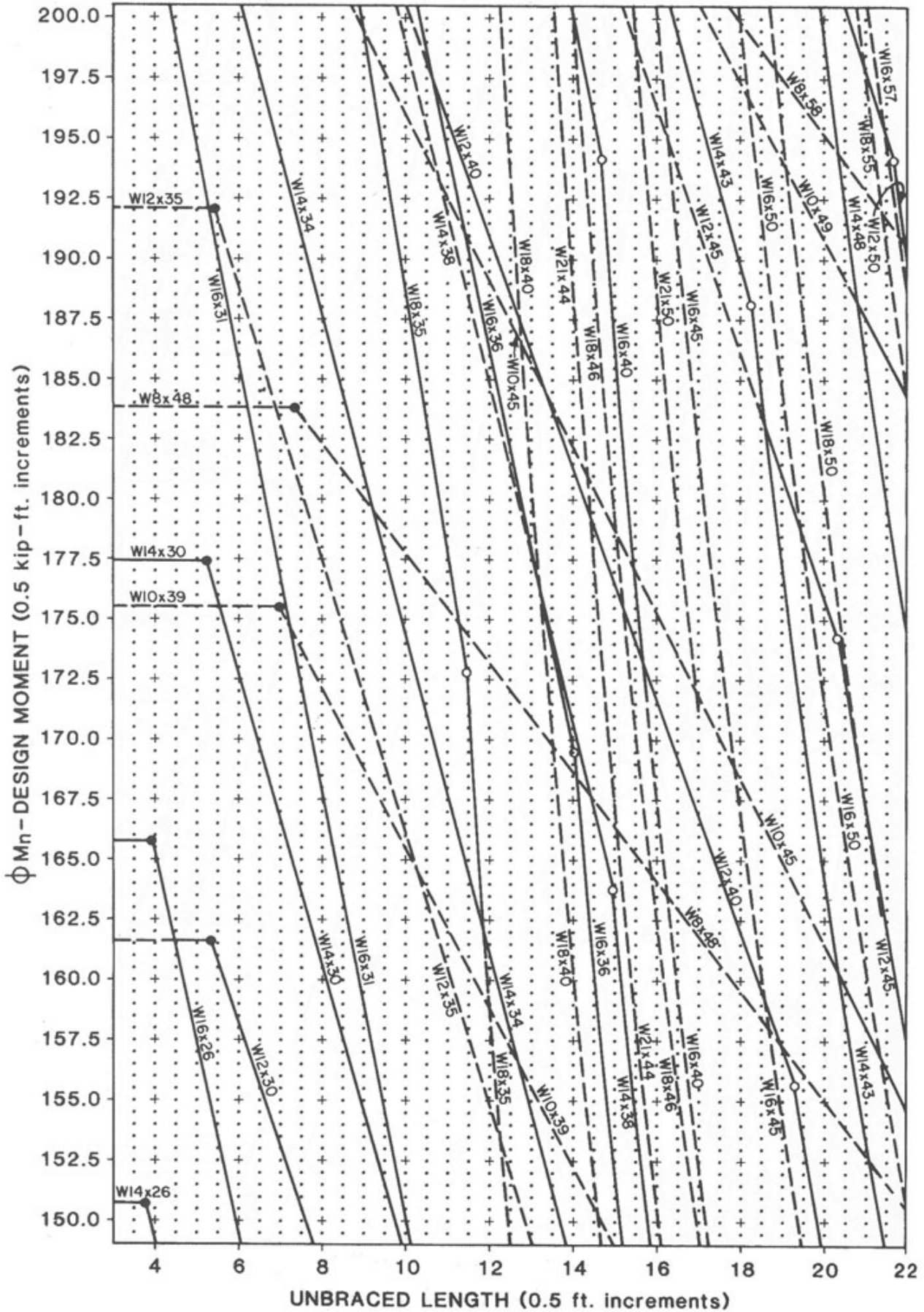
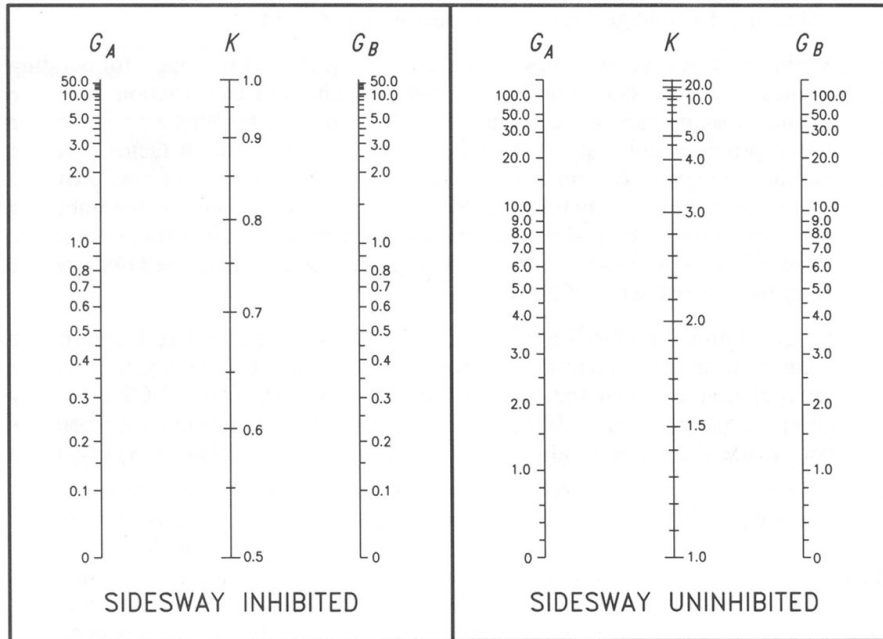

Table C–C.2.1. K VALUES FOR COLUMNS

Buckled shape of column is shown by dashed line.	(a)	(b)	(c)	(d)	(e)	(f)
Theoretical K value	0.5	0.7	1.0	1.0	2.0	2.0
Recommended design value when ideal conditions are approximated	0.65	0.80	1.2	1.0	2.10	2.0

Figure C – C.2.2.

ALIGNMENT CHART FOR EFFECTIVE LENGTH OF COLUMNS IN CONTINUOUS FRAMES



The subscripts A and B refer to the joints at the two ends of the column section being considered. G is defined as

$$G = \frac{\Sigma(I_c/L_c)}{\Sigma(I_g/L_g)}$$

in which Σ indicates a summation of all members rigidly connected to that joint and lying on the plane in which buckling of the column is being considered. I_c is the moment of inertia and L_c the unsupported length of a column section, and I_g is the moment of inertia and L_g the unsupported length of a girder or other restraining member. I_c and I_g are taken about axes perpendicular to the plane of buckling being considered.

For column ends supported by but not rigidly connected to a footing or foundation, G is theoretically infinity, but, unless actually designed as a true friction-free pin, may taken as "10" for practical designs. If the column end is rigidly attached to a properly designed footing, G may be taken as 1.0. Smaller values may be used if justified by analysis.

LRFD Table 3–50:
Design Stress for Compression Members of
50 ksi specified yield stress steel, $\phi_c = 0.85$ ^[a]

$\frac{Kl}{r}$	$\phi_c F_{cr}$ ksi	$\frac{Kl}{r}$	$\phi_c F_{cr}$ ksi	$\frac{Kl}{r}$	$\phi_c F_{cr}$ ksi	$\frac{Kl}{r}$	$\phi_c F_{cr}$ ksi	$\frac{Kl}{r}$	$\phi_c F_{cr}$ ksi
1	42.50	41	37.59	81	26.31	121	14.57	161	8.23
2	42.49	42	37.36	82	26.00	122	14.33	162	8.13
3	42.47	43	37.13	83	25.68	123	14.10	163	8.03
4	42.45	44	36.89	84	25.37	124	13.88	164	7.93
5	42.42	45	36.65	85	25.06	125	13.66	165	7.84
6	42.39	46	36.41	86	24.75	126	13.44	166	7.74
7	42.35	47	36.16	87	24.44	127	13.23	167	7.65
8	42.30	48	35.91	88	24.13	128	13.02	168	7.56
9	42.25	49	35.66	89	23.82	129	12.82	169	7.47
10	42.19	50	35.40	90	23.51	130	12.62	170	7.38
11	42.13	51	35.14	91	23.20	131	12.43	171	7.30
12	42.05	52	34.88	92	22.89	132	12.25	172	7.21
13	41.98	53	34.61	93	22.58	133	12.06	173	7.13
14	41.90	54	34.34	94	22.28	134	11.88	174	7.05
15	41.81	55	34.07	95	21.97	135	11.71	175	6.97
16	41.71	56	33.79	96	21.67	136	11.54	176	6.89
17	41.61	57	33.51	97	21.36	137	11.37	177	6.81
18	41.51	58	33.23	98	21.06	138	11.20	178	6.73
19	41.39	59	32.95	99	20.76	139	11.04	179	6.66
20	41.28	60	32.67	100	20.46	140	10.89	180	6.59
21	41.15	61	32.38	101	20.16	141	10.73	181	6.51
22	41.02	62	32.09	102	19.86	142	10.58	182	6.44
23	40.89	63	31.80	103	19.57	143	10.43	183	6.37
24	40.75	64	31.50	104	19.28	144	10.29	184	6.30
25	40.60	65	31.21	105	18.98	145	10.15	185	6.23
26	40.45	66	30.91	106	18.69	146	10.01	186	6.17
27	40.29	67	30.61	107	18.40	147	9.87	187	6.10
28	40.13	68	30.31	108	18.12	148	9.74	188	6.04
29	39.97	69	30.01	109	17.83	149	9.61	189	5.97
30	39.79	70	29.70	110	17.55	150	9.48	190	5.91
31	39.62	71	29.40	111	17.27	151	9.36	191	5.85
32	39.43	72	29.09	112	16.99	152	9.23	192	5.79
33	39.25	73	28.79	113	16.71	153	9.11	193	5.73
34	39.06	74	28.48	114	16.42	154	9.00	194	5.67
35	38.86	75	28.17	115	16.13	155	8.88	195	5.61
36	38.66	76	27.86	116	15.86	156	8.77	196	5.55
37	38.45	77	27.55	117	15.59	157	8.66	197	5.50
38	38.24	78	27.24	118	15.32	158	8.55	198	5.44
39	38.03	79	26.93	119	15.07	159	8.44	199	5.39
40	37.81	80	26.62	120	14.82	160	8.33	200	5.33

[a] When element width-to-thickness ratio exceeds λ_r , see Appendix B5.3.

ALLOWABLE STRESS DESIGN SELECTION TABLE									
For shapes used as beams									
$F_y = 50$ ksi			S_x	Shape	Depth d	F'_y	$F_y = 36$ ksi		
L_c	L_u	M_R					L_c	L_u	M_R
Ft	Ft	Kip-ft	In. ³		In.	Ksi	Ft	Ft	Kip-ft
8.1	8.6	484	176	W24×76	23 7/8	--	9.5	11.8	348
9.3	20.2	481	175	W16×100	17	--	11.0	28.1	347
13.1	29.2	476	173	W14×109	14 3/8	58.6	15.4	40.6	343
7.5	10.9	470	171	W21×83	21 3/8	--	8.8	15.1	339
9.9	15.5	457	166	W18×86	18 3/8	--	11.7	21.5	329
13.0	26.7	432	157	W14×99	14 1/8	48.5	15.4	37.0	311
9.3	18.0	426	155	W16×89	16 3/4	--	10.9	25.0	307
7.4	8.5	424	154	W24×68	23 3/4	--	9.5	10.2	305
7.4	9.6	415	151	W21×73	21 1/4	--	8.8	13.4	299
9.9	13.7	402	146	W18×76	18 1/4	64.2	11.6	19.1	289
13.0	24.5	385	143	W14×90	14	40.4	15.3	34.0	283
7.4	8.9	385	140	W21×68	21 1/8	--	8.7	12.4	277
9.2	15.8	369	134	W16×77	16 1/2	--	10.9	21.9	265
5.8	6.4	360	131	W24×62	23 3/4	--	7.4	8.1	259
7.4	8.1	349	127	W21×62	21	--	8.7	11.2	251
6.8	11.1	349	127	W18×71	18 1/2	--	8.1	15.5	251
9.1	20.2	338	123	W14×82	14 1/4	--	10.7	28.1	244
10.9	26.0	325	118	W12×87	12 1/2	--	12.8	36.2	234
6.8	10.4	322	117	W18×65	18 3/8	--	8.0	14.4	232
9.2	13.9	322	117	W16×67	16 3/8	--	10.8	19.3	232
5.0	6.3	314	114	W24×55	23 5/8	--	7.0	7.5	226
9.0	18.6	308	112	W14×74	14 1/8	--	10.6	25.9	222
5.9	6.7	305	111	W21×57	21	--	6.9	9.4	220
6.8	9.6	297	108	W18×60	18 1/4	--	8.0	13.3	214
10.8	24.0	294	107	W12×79	12 3/8	62.6	12.8	33.3	212
9.0	17.2	283	103	W14×68	14	--	10.6	23.9	204
6.7	8.7	270	98.3	W18×55	18 1/8	--	7.9	12.1	195
10.8	21.9	268	97.4	W12×72	12 1/4	52.3	12.7	30.5	193
5.6	6.0	260	94.5	W21×50	20 7/8	--	6.9	7.8	187
6.4	10.3	254	92.2	W16×57	16 3/8	--	7.5	14.3	183
9.0	15.5	254	92.2	W14×61	13 7/8	--	10.6	21.5	183
6.7	7.9	244	88.9	W18×50	18	--	7.9	11.0	176
10.7	20.0	238	87.9	W12×65	12 1/8	43.0	12.7	27.7	174
4.7	5.9	224	81.6	W21×44	20 5/8	--	6.6	7.0	162
6.3	9.1	223	81.0	W16×50	16 1/4	--	7.5	12.7	160
5.4	6.8	217	78.8	W18×46	18	--	6.4	9.4	156
9.0	17.5	215	78.0	W12×58	12 1/4	--	10.6	24.4	154
7.2	12.7	214	77.8	W14×53	13 7/8	--	8.5	17.7	154
6.3	8.2	200	72.7	W16×45	16 1/8	--	7.4	11.4	144
9.0	15.9	194	70.6	W12×53	12	55.9	10.6	22.0	140
7.2	11.5	193	70.3	W14×48	13 3/4	--	8.5	16.0	139

ALLOWABLE MOMENTS IN BEAMS ($C_b = 1, F_y = 50$ ksi)

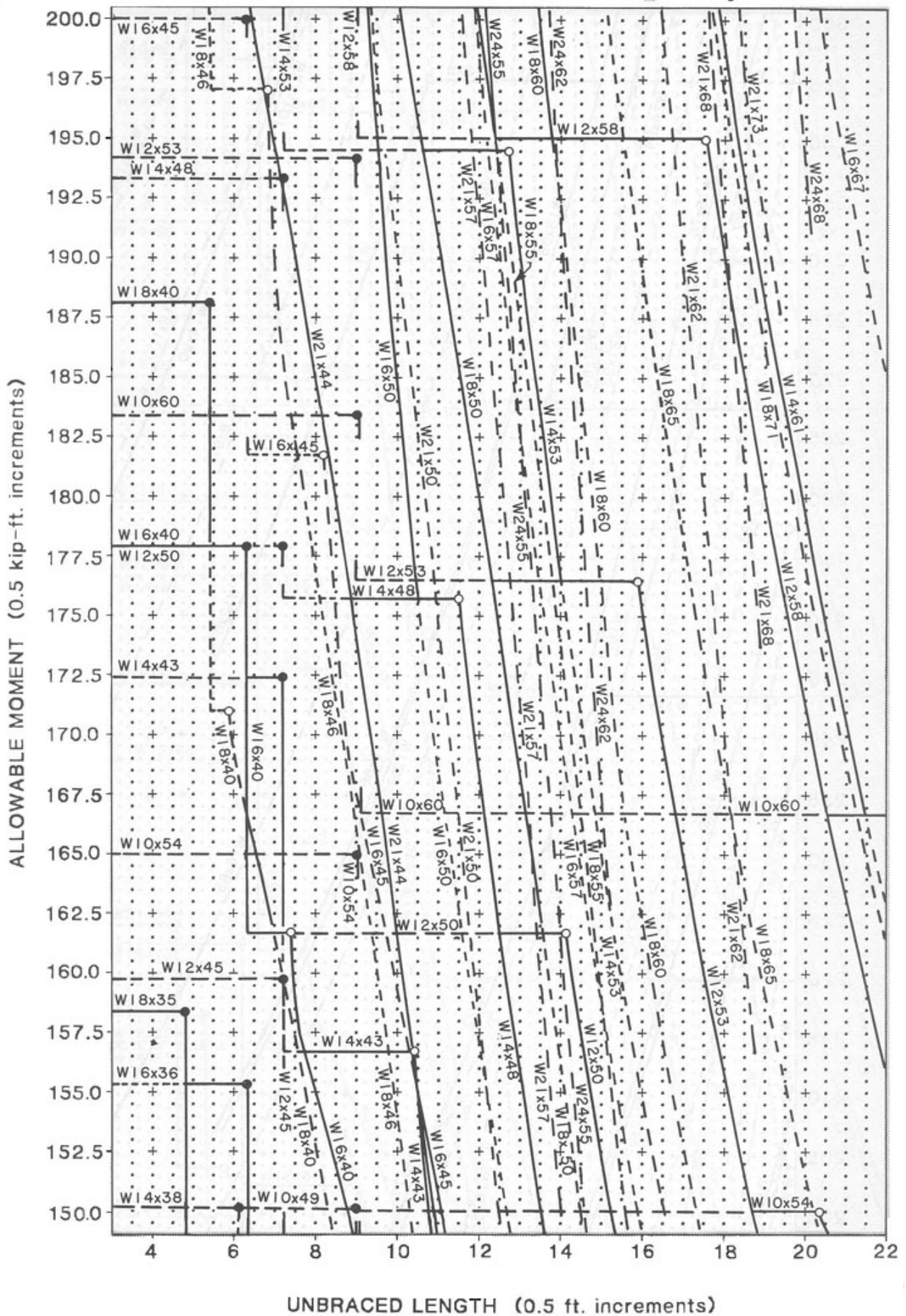

**ASD Table C-50. Allowable Stress
for compression Members of 50-ksi Specified Yield Stress Steel^{a,b}**

$\frac{Kl}{r}$	F_a (ksi)	$\frac{Kl}{r}$	F_a (ksi)	$\frac{Kl}{r}$	F_a (ksi)	$\frac{Kl}{r}$	F_a (ksi)	$\frac{Kl}{r}$	F_a (ksi)
1	29.94	41	25.69	81	18.81	121	10.20	161	5.76
2	29.87	42	25.55	82	18.61	122	10.03	162	5.69
3	29.80	43	25.40	83	18.41	123	9.87	163	5.62
4	29.73	44	25.26	84	18.20	124	9.71	164	5.55
5	29.66	45	25.11	85	17.99	125	9.56	165	5.49
6	29.58	46	24.96	86	17.79	126	9.41	166	5.42
7	29.50	47	24.81	87	17.58	127	9.26	167	5.35
8	29.42	48	24.66	88	17.37	128	9.11	168	5.29
9	29.34	49	24.51	89	17.15	129	8.97	169	5.23
10	29.26	50	24.35	90	16.94	130	8.84	170	5.17
11	29.17	51	24.19	91	16.72	131	8.70	171	5.11
12	29.08	52	24.04	92	16.50	132	8.57	172	5.05
13	28.99	53	23.88	93	16.29	133	8.44	173	4.99
14	28.90	54	23.72	94	16.06	134	8.32	174	4.93
15	28.80	55	23.55	95	15.84	135	8.19	175	4.88
16	28.71	56	23.39	96	15.62	136	8.07	176	4.82
17	28.61	57	23.22	97	15.39	137	7.96	177	4.77
18	28.51	58	23.06	98	15.17	138	7.84	178	4.71
19	28.40	59	22.89	99	14.94	139	7.73	179	4.66
20	28.30	60	22.72	100	14.71	140	7.62	180	4.61
21	28.19	61	22.55	101	14.47	141	7.51	181	4.56
22	28.08	62	22.37	102	14.24	142	7.41	182	4.51
23	27.97	63	22.20	103	14.00	143	7.30	183	4.46
24	27.86	64	22.02	104	13.77	144	7.20	184	4.41
25	27.75	65	21.85	105	13.53	145	7.10	185	4.36
26	27.63	66	21.67	106	13.29	146	7.01	186	4.32
27	27.52	67	21.49	107	13.04	147	6.91	187	4.27
28	27.40	68	21.31	108	12.80	148	6.82	188	4.23
29	27.28	69	21.12	109	12.57	149	6.73	189	4.18
30	27.15	70	20.94	110	12.34	150	6.64	190	4.14
31	27.03	71	20.75	111	12.12	151	6.55	191	4.09
32	26.90	72	20.56	112	11.90	152	6.46	192	4.05
33	26.77	73	20.38	113	11.69	153	6.38	193	4.01
34	26.64	74	20.10	114	11.49	154	6.30	194	3.97
35	26.51	75	19.99	115	11.29	155	6.22	195	3.93
36	26.38	76	19.80	116	11.10	156	6.14	196	3.89
37	26.25	77	19.61	117	10.91	157	6.06	197	3.85
38	26.11	78	19.41	118	10.72	158	5.98	198	3.81
39	25.97	79	19.21	119	10.55	159	5.91	199	3.77
40	25.83	80	19.01	120	10.37	160	5.83	200	3.73

^a When element width-to-thickness ratio exceeds noncompact section limits of Sect. B5.1, see Appendix B5.

^b Values also applicable for steel of any yield stress ≥ 39 ksi.

Note: $C_c = 107.0$

ENVIRONMENTAL ENGINEERING

For information about environmental engineering refer to the **ENVIRONMENTAL ENGINEERING** section.

HYDROLOGY

NRCS (SCS) Rainfall-Runoff

$$Q = \frac{(P - 0.2S)^2}{P + 0.8S},$$

$$S = \frac{1,000}{CN} - 10,$$

$$CN = \frac{1,000}{S + 10},$$

- P = precipitation (inches),
- S = maximum basin retention (inches),
- Q = runoff (inches), and
- CN = curve number.

Rational Formula

$$Q = CIA, \text{ where}$$

- A = watershed area (acres),
- C = runoff coefficient,
- I = rainfall intensity (in/hr), and
- Q = discharge (cfs).

DARCY'S EQUATION

$$Q = -KA(dH/dx), \text{ where}$$

- Q = Discharge rate (ft³/s or m³/s),
- K = Hydraulic conductivity (ft/s or m/s),
- H = Hydraulic head (ft or m), and
- A = Cross-sectional area of flow (ft² or m²).

SEWAGE FLOW RATIO CURVES

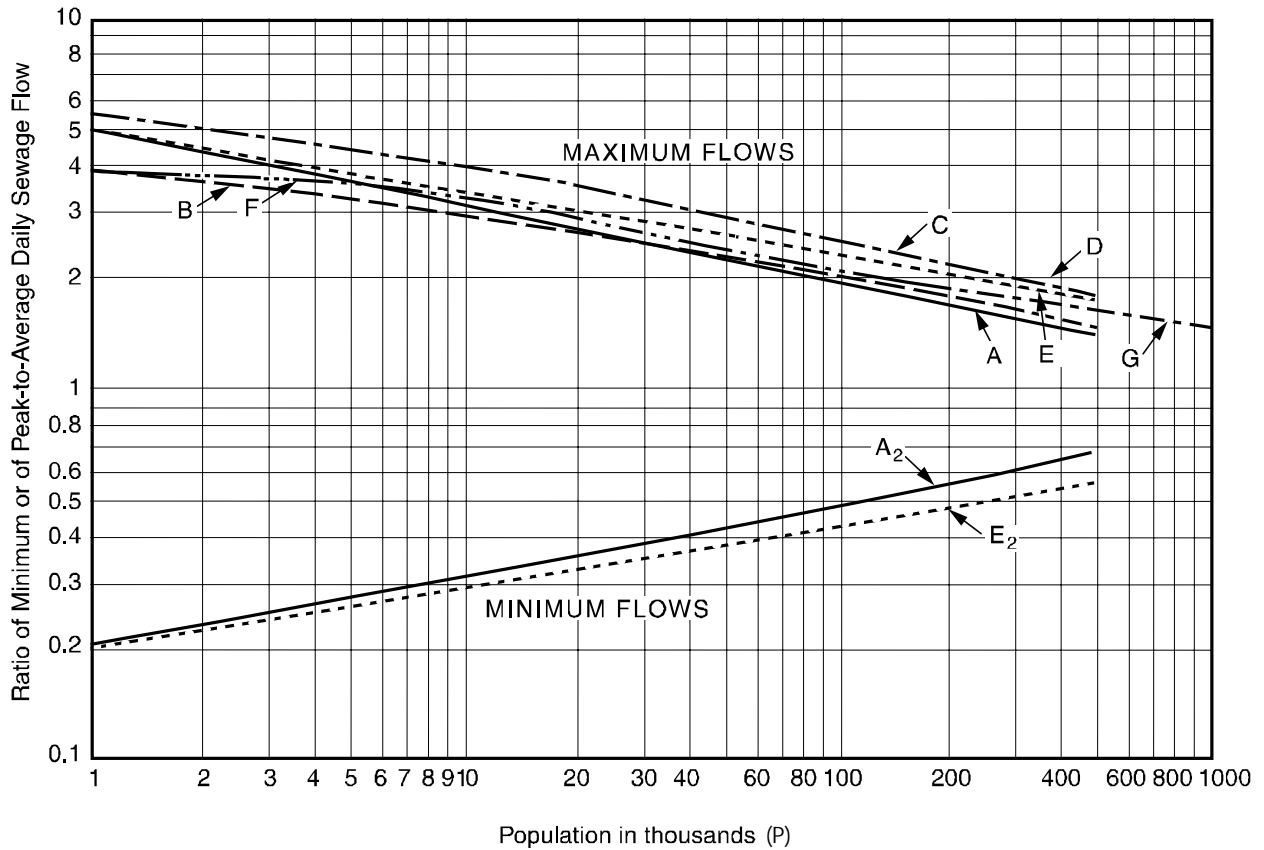

Curve A₂: $\frac{5}{P^{0.167}}$ Curve B: $\frac{14}{4 + \sqrt{P}} + 1$ Curve G: $\frac{18 + \sqrt{P}}{4 + \sqrt{P}}$

HYDRAULIC-ELEMENTS GRAPH FOR CIRCULAR SEWERS

Values of: $\frac{f}{f_f}$ and $\frac{n}{n_f}$

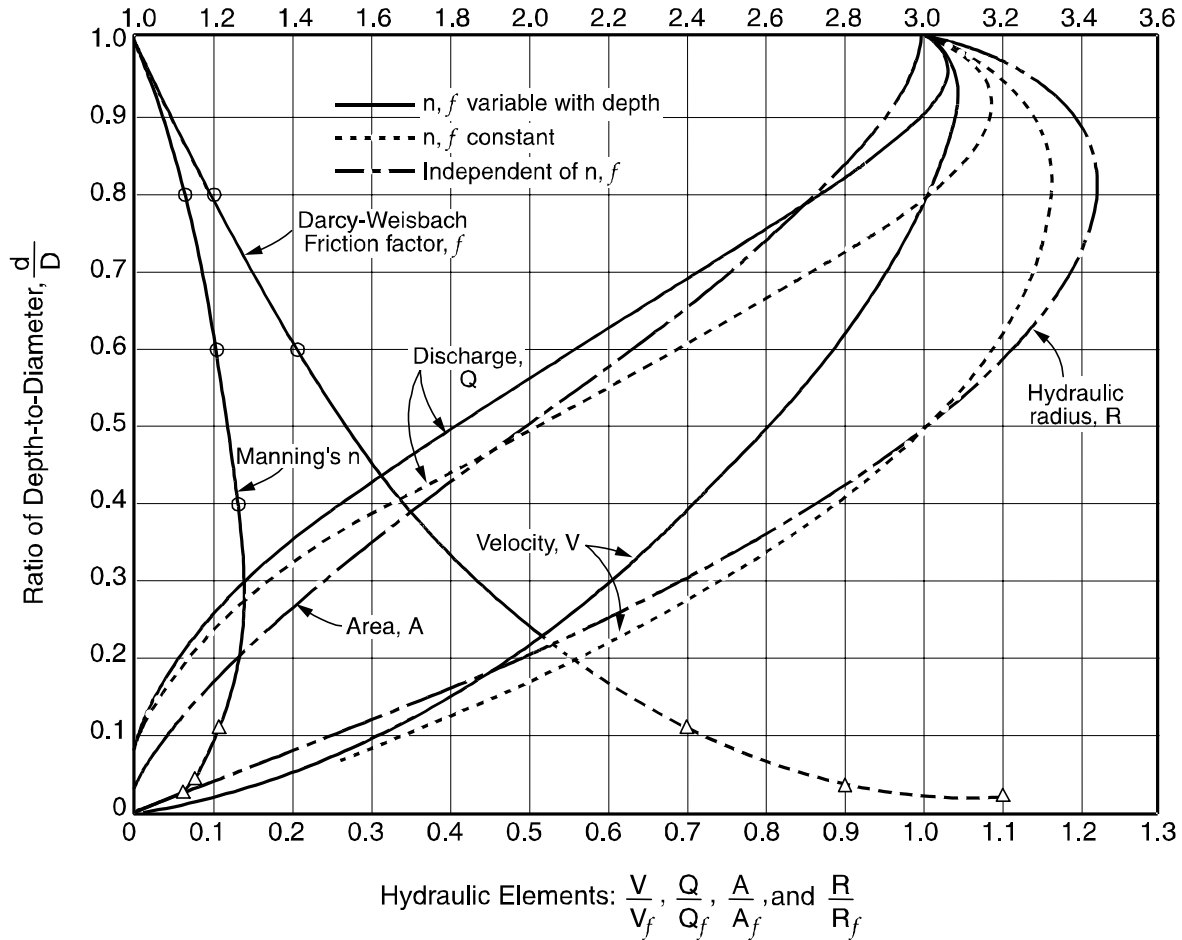

Open-Channel Flow

Specific Energy

$$E = \alpha \frac{V}{2g} + y = \frac{\alpha Q^2}{2gA^2} + y, \text{ where}$$

E = specific energy,

Q = discharge,

V = velocity,

y = depth of flow,

A = cross-sectional area of flow, and

α = kinetic energy correction factor, usually 1.0.

Critical Depth = that depth in a channel at minimum specific energy

$$\frac{Q^2}{g} = \frac{A^3}{T}$$

where Q and A are as defined above,

g = acceleration due to gravity, and

T = width of the water surface.

For rectangular channels

$$y_c = \left(\frac{q^2}{g} \right)^{1/3}, \text{ where}$$

y_c = critical depth,

q = unit discharge = Q/B ,

B = channel width, and

g = acceleration due to gravity.

Froude Number = ratio of inertial forces to gravity forces

$$F = \frac{V}{\sqrt{gy_h}}, \text{ where}$$

V = velocity, and

y_h = hydraulic depth = A/T

Specific Energy Diagram

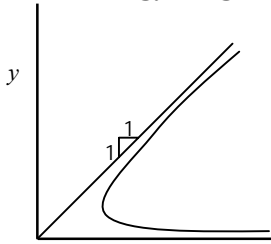

$$E = \frac{\alpha V^2}{2g} + y$$

Alternate depths – depths with the same specific energy.

Uniform Flow – a flow condition where depth and velocity do not change along a channel.

Manning's Equation

$$Q = \frac{K}{n} AR^{2/3} S^{1/2}$$

Q = discharge (m³/s or ft³/s),

K = 1.486 for USCS units, 1.0 for SI units,

A = cross-sectional area of flow (m² or ft²),

R = hydraulic radius = A/P (m or ft),

P = wetted perimeter (m or ft),

S = slope of hydraulic surface (m/m or ft/ft), and

n = Manning's roughness coefficient.

Normal depth – the uniform flow depth

$$AR^{2/3} = \frac{Qn}{KS^{1/2}}$$

Weir Formulas

Fully submerged with no side restrictions

$$Q = CLH^{3/2}$$

V-Notch

$$Q = CH^{5/2}, \text{ where}$$

Q = discharge (cfs or m³/s),

C = 3.33 for submerged rectangular weir (USCS units),

C = 1.84 for submerged rectangular weir (SI units),

C = 2.54 for 90° V-notch weir (USCS units),

C = 1.40 for 90° V-notch weir (SI units),

L = Weir length (ft or m), and

H = head (depth of discharge over weir) ft or m.

Hazen-Williams Equation

$$V = k_1 CR^{0.63} S^{0.54}, \text{ where}$$

C = roughness coefficient,

k_1 = 0.849 for SI units, and

k_1 = 1.318 for USCS units,

R = hydraulic radius (ft or m),

S = slope of energy gradeline,

= h_f/L (ft/ft or m/m), and

V = velocity (ft/s or m/s).

Values of Hazen-Williams Coefficient C

Pipe Material	C
Concrete (regardless of age)	130
Cast iron:	
New	130
5 yr old	120
20 yr old	100
Welded steel, new	120
Wood stave (regardless of age)	120
Vitrified clay	110
Riveted steel, new	110
Brick sewers	100
Asbestos-cement	140
Plastic	150

For additional fluids information, see the **FLUID MECHANICS** section.

TRANSPORTATION

Stopping Sight Distance

$$S = \frac{v^2}{2g(f \pm G)} + Tv, \text{ where}$$

S = stopping sight distance (feet),

v = initial speed (feet/second),

g = acceleration of gravity,

f = coefficient of friction between tires and roadway,

G = grade of road (% /100), and

T = driver reaction time (second).

Sight Distance Related to Curve Length

a. Crest – Vertical Curve:

$$L = \frac{AS^2}{100(\sqrt{2h_1} + \sqrt{2h_2})^2} \quad \text{for } S < L$$

$$L = 2S - \frac{200(\sqrt{h_1} + \sqrt{h_2})^2}{A} \quad \text{for } S > L$$

where

L = length of vertical curve (feet),

A = algebraic difference in grades (%),

S = sight distance (stopping or passing, feet),

h_1 = height of drivers' eyes above the roadway surface (feet), and

h_2 = height of object above the roadway surface (feet).

When $h_1 = 3.50$ feet and $h_2 = 0.5$ feet,

$$L = \frac{AS^2}{1,329} \quad \text{for } S < L$$

$$L = 2S - \frac{1,329}{A} \quad \text{for } S > L$$

b. Sag – Vertical Curve (standard headlight criteria):

$$L = \frac{AS^2}{400 + 3.5 S} \quad \text{for } S < L$$

$$L = 2S - \frac{400 + 3.5 S}{A} \quad \text{for } S > L$$

c. Riding comfort (centrifugal acceleration) on sag vertical curve:

$$\text{where } L = \frac{AV^2}{46.5},$$

L = length of vertical curve (feet), and

V = design speed (mph).

d. Adequate sight distance under an overhead structure to see an object beyond a sag vertical curve:

$$L = \frac{AS^2}{800} \left(C - \frac{h_1 + h_2}{2} \right)^{-1} \quad \text{for } S < L$$

$$L = 2S - \frac{800}{A} \left(C - \frac{h_1 + h_2}{2} \right) \quad \text{for } S > L$$

where

C = vertical clearance for overhead structure (underpass) located within 200 feet (60 m) of the midpoint of the curve.

e. Horizontal Curve (to see around an obstruction):

$$M = \frac{5,729.58}{D} \left(1 - \cos \frac{DS}{200} \right)$$

$$M = \frac{S^2}{8R}, \text{ where}$$

D = degree of curve,

M = middle ordinate (feet),

S = stopping sight distance (feet), and

R = curve radius (feet).

Superelevation of Horizontal Curves

a. Highways:

$$e + f = \frac{v^2}{gR}, \text{ where}$$

e = superelevation,

f = side-friction factor,

g = acceleration of gravity,

v = speed of vehicle, and

R = radius of curve (minimum).

b. Railroads:

$$E = \frac{Gv^2}{gR}, \text{ where}$$

g = acceleration of gravity,

v = speed of train,

E = equilibrium elevation of the outer rail,

G = effective gage (center-to-center of rails), and

R = radius of curve.

Spiral Transitions to Horizontal Curves

a. Highways:

$$L_s = 1.6 \frac{V^3}{R}$$

b. Railroads:

$$L_s = 62E$$

$$E = 0.0007V^2D$$

where

D = degree of curve,

E = equilibrium elevation of outer rail (inches),

L_s = length of spiral (feet),

R = radius of curve (feet), and

V = speed (mph).

Metric Stopping Sight Distance

$$S = 0.278 TV + \frac{V^2}{254(f \pm G)}, \text{ where}$$

S = stopping sight distance (m),

V = initial speed km/hr,

G = grade of road (% /100),

T = driver reaction time (seconds), and

f = coefficient of friction between tires and roadway.

Highway Superelevation (metric)

$$\frac{e}{100} + f = \frac{V^2}{127R}, \text{ where}$$

e = rate of roadway superelevation in %,

f = side friction factor,

R = radius of curve (minimum) (m), and

V = vehicle speed (km/hr).

Highway Spiral Curve Length (metric)

$$L_s = \frac{0.0702 V^3}{RC}, \text{ where}$$

L_s = length of spiral (m),

V = vehicle speed (km/hr),

R = curve radius (m), and

C = 1 to 3, often used as 1.

Sight Distance, Crest Vertical Curves (metric)

$$L = \frac{AS^2}{100(\sqrt{2h_1} + \sqrt{2h_2})^2} \quad \text{For } S < L$$

$$L = 2S - \frac{200(\sqrt{h_1} + \sqrt{h_2})^2}{A} \quad \text{For } S > L$$

- where
- L = length of vertical curve (m),
 - S = sight distance (stopping or passing, m),
 - A = algebraic difference in grades %,
 - h_1 = height of driver's eye above roadway surface (m), and
 - h_2 = height of object above roadway surface (m).

Sight Distance, Sag Vertical Curves (metric)

$$L = \frac{AS^2}{120 + 3.5S} \quad \text{For } S < L$$

$$L = 2S - \left(\frac{120 + 3.5S}{A} \right) \quad \text{For } S > L$$

Both 1° upward headlight illumination

Highway Sag Vertical Curve Criterion for Driver or Passenger Comfort (metric)

$$L = \frac{AV^2}{395}, \text{ where}$$

V = vehicle speed (km/hr).

Modified Davis Equation – Railroads

$$R = 0.6 + 20/W + 0.01V + KV^2/(WN)$$

where

- K = air resistance coefficient,
- N = number of axles,
- R = level tangent resistance [lb/(ton of car weight)],
- V = train or car speed (mph), and
- W = average load per axle (tons).

Standard values of K

- $K = 0.0935$, containers on flat car,
- $K = 0.16$, trucks or trailers on flat car, and
- $K = 0.07$, all other standard rail units.

Railroad curve resistance is 0.8 lb per ton of car weight per degree of curvature.

$$TE = 375 \text{ (HP)} e/V, \text{ where}$$

e = efficiency of diesel-electric drive system (0.82 to 0.93),

HP = rated horsepower of a diesel-electric locomotive unit,

TE = tractive effort (lb force of a locomotive unit), and

V = locomotive speed (mph).

AREA Vertical Curve Criteria for Track Profile

Maximum Rate of Change of Gradient in Percent Grade per Station		
Line Rating	In Sags	On Crests
High-speed Main Line Tracks	0.05	0.10
Secondary or Branch Line Tracks	0.10	0.20

Transportation Models

Optimization models and methods, including queueing theory, can be found in the **INDUSTRIAL ENGINEERING** section.

Traffic Flow Relationships ($q = kv$)

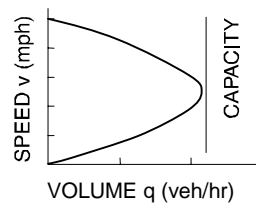
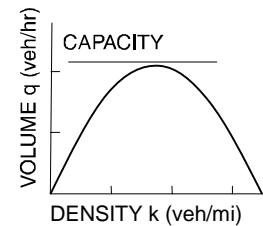
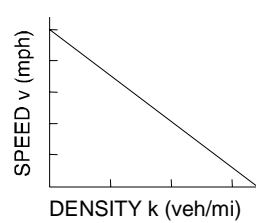

AIRPORT LAYOUT AND DESIGN

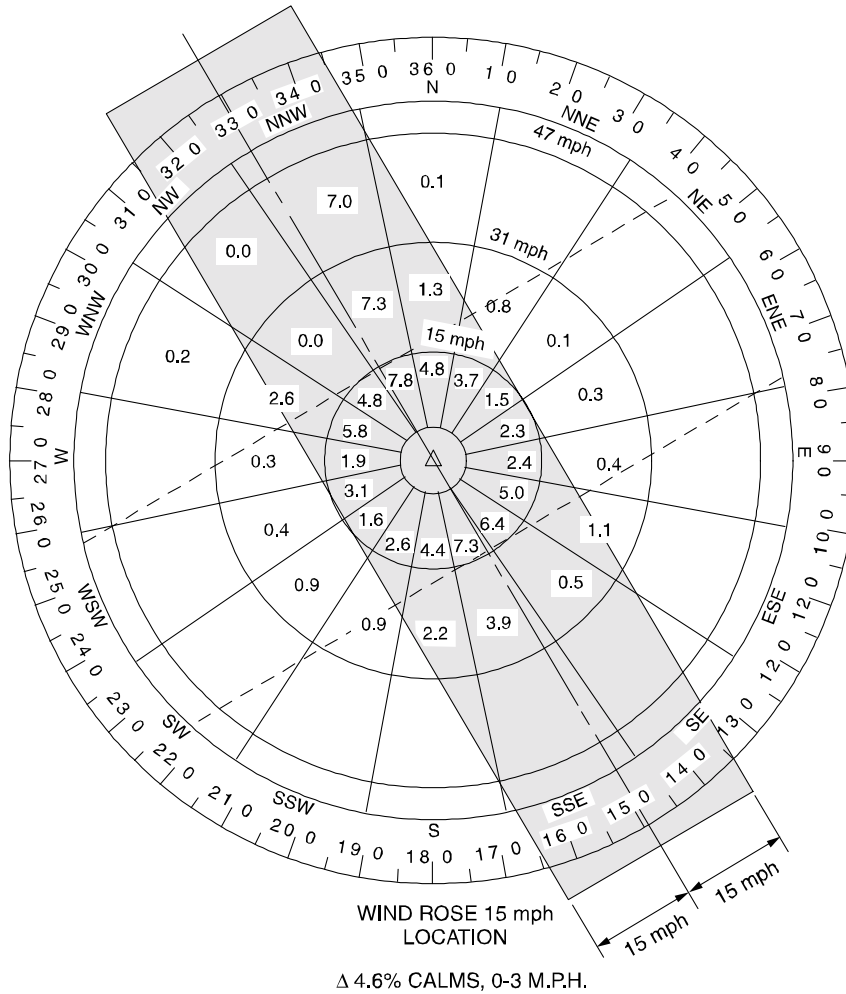

1. Cross-wind component of 12 mph maximum for aircraft of 12,500 lb or less weight and 15 mph maximum for aircraft weighing more than 12,500 lb.
2. Cross-wind components maximum shall not be exceeded more than 5% of the time at an airport having a single runway.
3. A cross-wind runway is to be provided if a single runway does not provide 95% wind coverage with less than the maximum cross-wind component.

LONGITUDINAL GRADE DESIGN CRITERIA FOR RUNWAYS

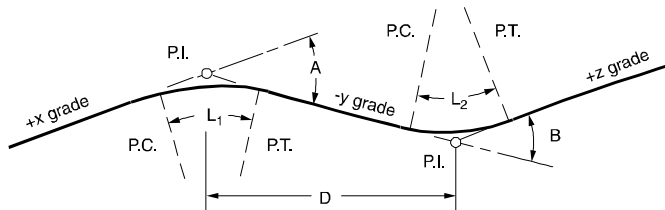

Item	Transport Airports	Utility Airports
Maximum longitudinal grade (percent)	1.5	2.0
Maximum grade change such as A or B (percent)	1.5	2.0
Maximum grade, first and last quarter of runway (percent)	0.8	-----
Minimum distance (D, feet) between P.I.'s for vertical curves	1,000 (A + B) ^a	250 (A + B) ^a
Minimum length of vertical curve (L, feet) per 1 percent grade change	1,000	300

^a Use absolute values of A and B (percent).

AUTOMOBILE PAVEMENT DESIGN

AASHTO Structural Number Equation

$$SN = a_1D_1 + a_2D_2 + \dots + a_nD_n, \text{ where}$$

SN = structural number for the pavement

a_i = layer coefficient and D_i = thickness of layer (inches).

EARTHWORK FORMULAS

Average End Area Formula, $V = L(A_1 + A_2)/2$,

Prismoidal Formula, $V = L (A_1 + 4A_m + A_2)/6$, where A_m = area of mid-section

Pyramid or Cone, $V = h (\text{Area of Base})/3$,

AREA FORMULAS

Area by Coordinates: $\text{Area} = [X_A (Y_B - Y_N) + X_B (Y_C - Y_A) + X_C (Y_D - Y_B) + \dots + X_N (Y_A - Y_{N-1})] / 2$,

Trapezoidal Rule: $\text{Area} = w \left(\frac{h_1 + h_n}{2} + h_2 + h_3 + h_4 + \dots + h_{n-1} \right)$ w = common interval,

Simpson's 1/3 Rule: $\text{Area} = w \left[h_1 + 2 \left(\sum_{k=3,5,\dots}^{n-2} h_k \right) + 4 \left(\sum_{k=2,4,\dots}^{n-1} h_k \right) + h_n \right] / 3$ n must be odd number of measurements,
 w = common interval

CONSTRUCTION

Construction project scheduling and analysis questions may be based on either activity-on-node method or on activity-on-arrow method.

CPM PRECEDENCE RELATIONSHIPS (ACTIVITY ON NODE)

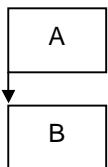

Start-to-start: start of B depends on the start of A

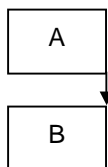

Finish-to-finish: finish of B depends on the finish of A

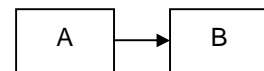

Finish-to-start: start of B depends on the finish of A

VERTICAL CURVE FORMULAS

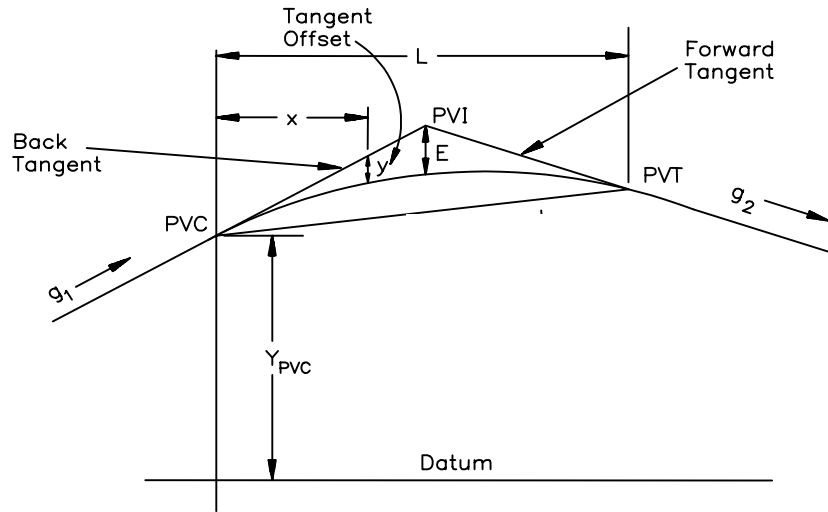

VERTICAL CURVE FORMULAS
NOT TO SCALE

- | | |
|--|----------------------------------|
| L = Length of Curve (horizontal) | g_2 = Grade of Forward Tangent |
| PVC = Point of Vertical Curvature | a = Parabola Constant |
| PVI = Point of Vertical Intersection | y = Tangent Offset |
| PVT = Point of Vertical Tangency | E = Tangent Offset at PVI |
| g_1 = Grade of Back Tangent | r = Rate of Change of Grade |
| x = Horizontal Distance from PVC
(or point of tangency) to Point on Curve | |

$$x_m = \text{Horizontal Distance to Min/Max Elevation on Curve} = -\frac{g_1}{2a} = \frac{g_1 L}{g_1 - g_2}$$

$$\text{Tangent Elevation} = Y_{PVC} + g_1 x \quad \text{and} \quad = Y_{PVI} + g_2 (x - L/2)$$

$$\text{Curve Elevation} = Y_{PVC} + g_1 x + ax^2 = Y_{PVC} + g_1 x + [(g_2 - g_1)/(2L)]x^2$$

$$y = ax^2; \quad a = \frac{g_2 - g_1}{2L};$$

$$E = a \left(\frac{L}{2}\right)^2; \quad r = \frac{g_2 - g_1}{L}$$

HORIZONTAL CURVE FORMULAS

- D = Degree of Curve, Arc Definition
- P.C. = Point of Curve (also called B.C.)
- P.T. = Point of Tangent (also called E.C.)
- P.I. = Point of Intersection
- I = Intersection Angle (also called Δ)
Angle between two tangents
- L = Length of Curve,
from P.C. to P.T.
- T = Tangent Distance
- E = External Distance
- R = Radius
- L.C. = Length of Long Chord
- M = Length of Middle Ordinate
- c = Length of Sub-Chord
- d = Angle of Sub-Chord

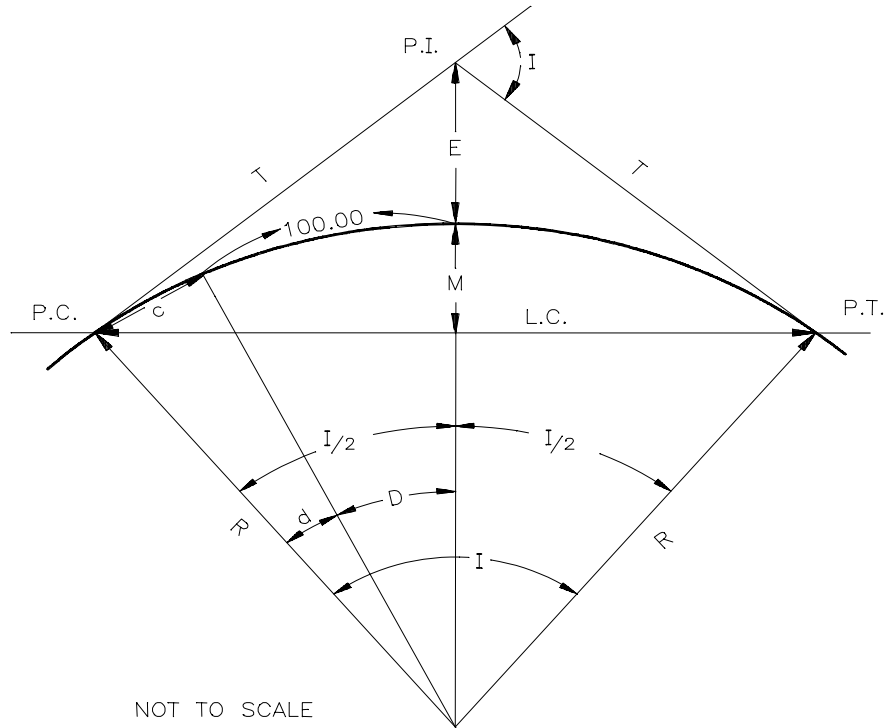

NOT TO SCALE

$$R = \frac{L.C.}{2 \sin(I/2)}; \quad T = R \tan(I/2) = \frac{L.C.}{2 \cos(I/2)}$$

$$R = \frac{5729.58}{D}; \quad L = RI \frac{\pi}{180} = \frac{I}{D} 100$$

$$M = R [1 - \cos(I/2)]$$

$$\frac{R}{E + R} = \cos(I/2); \quad \frac{R - M}{R} = \cos(I/2)$$

$$c = 2R \sin(d/2);$$

$$E = R \left[\frac{1}{\cos(I/2)} - 1 \right]$$

Deflection angle per 100 feet of arc length equals $\frac{D}{2}$

ENVIRONMENTAL ENGINEERING

PLANNING

Population Projection Equations

Linear Projection = Algebraic Projection

$$P_T = P_0 + k\Delta t, \text{ where}$$

- P_T = population at time T,
 P_0 = population at time zero (fitting parameter),
 k = growth rate (fitting parameter), and
 Δt = elapsed time in years relative to time zero.

Log Growth = Exponential Growth = Geometric Growth

$$P_T = P_0 e^{k\Delta t}$$

$$\ln P_T = \ln P_0 + k\Delta t, \text{ where}$$

- P_T = population at time T,
 P_0 = population at time zero (fitting parameter),
 k = growth rate (fitting parameter), and
 Δt = elapsed time in years relative to time zero.

WATER

For information about fluids, refer to the **CIVIL ENGINEERING** and **FLUID MECHANICS** sections.

For information about hydrology and geohydrology, refer to the **CIVIL ENGINEERING** section.

Stream Modeling: Streeter Phelps

$$D = \frac{k_d S_o}{k_a - k_d} [\exp(-k_d t) - \exp(-k_a t)] + D_o \exp(-k_a t)$$

$$t_c = \frac{1}{k_a - k_d} \ln \left[\frac{k_a}{k_d} \left(1 - D_o \frac{(k_a - k_d)}{k_d S_o} \right) \right]$$

$$D = DO_{\text{sat}} - DO, \text{ where}$$

- D = dissolved oxygen deficit (mg/L),
 k_d = deoxygenation rate constant, base e, days⁻¹,
 t = time, days,
 k_a = reaeration rate, base e, days⁻¹,
 S_o = initial BOD ultimate in mixing zone, mg/L,
 D_o = initial dissolved oxygen deficit in mixing zone (mg/L),
 t_c = time which corresponds with minimum dissolved oxygen (mg/L),
 DO_{sat} = saturated dissolved oxygen concentration (mg/L), and
 DO = dissolved oxygen concentration (mg/L).

WATER AND WASTEWATER TECHNOLOGIES

For information about reactor design (batch, plug flow, and complete mix), refer to the **CHEMICAL ENGINEERING** section.

Approach velocity = horizontal velocity = Q/A_x ,

Hydraulic loading rate = Q/A , and

Hydraulic residence time = $V/Q = \theta$.

where

Q = flow rate,

A_x = cross-sectional area,

A = surface area, plan view, and

V = tank volume.

Lime-Soda Softening Equations

50 mg/L as CaCO₃ equivalent = 1 meq/L

- Carbon dioxide removal
 $\text{CO}_2 + \text{Ca}(\text{OH})_2 \rightarrow \text{CaCO}_3(\text{s}) + \text{H}_2\text{O}$
- Calcium carbonate hardness removal
 $\text{Ca}(\text{HCO}_3)_2 + \text{Ca}(\text{OH})_2 \rightarrow 2\text{CaCO}_3(\text{s}) + 2\text{H}_2\text{O}$
- Calcium non-carbonate hardness removal
 $\text{CaSO}_4 + \text{Na}_2\text{CO}_3 \rightarrow \text{CaCO}_3(\text{s}) + 2\text{Na}^+ + \text{SO}_4^{2-}$
- Magnesium carbonate hardness removal
 $\text{Mg}(\text{HCO}_3)_2 + 2\text{Ca}(\text{OH})_2 \rightarrow 2\text{CaCO}_3(\text{s}) + \text{Mg}(\text{OH})_2(\text{s}) + 2\text{H}_2\text{O}$
- Magnesium non-carbonate hardness removal
 $\text{MgSO}_4 + \text{Ca}(\text{OH})_2 + \text{Na}_2\text{CO}_3 \rightarrow \text{CaCO}_3(\text{s}) + \text{Mg}(\text{OH})_2(\text{s}) + 2\text{Na}^+ + \text{SO}_4^{2-}$
- Destruction of excess alkalinity
 $2\text{HCO}_3^- + \text{Ca}(\text{OH})_2 \rightarrow \text{CaCO}_3(\text{s}) + \text{CO}_3^{2-} + 2\text{H}_2\text{O}$
- Recarbonation
 $\text{Ca}^{2+} + 2\text{OH}^- + \text{CO}_2 \rightarrow \text{CaCO}_3(\text{s}) + \text{H}_2\text{O}$

Equivalent Weights	Molecular Weight	n		Equivalent Weight
		#	Equiv mole	
CO ₃ ²⁻	60.008	2		30.004
CO ₂	44.009	2		22.004
Ca(OH) ₂	74.092	2		37.046
CaCO ₃	100.086	2		50.043
Ca(HCO₃)₂	162.110	2		81.055
CaSO ₄	136.104	2		68.070
Ca ²⁺	40.078	2		20.039
H ⁺	1.008	1		1.008
HCO ₃ ⁻	61.016	1		61.016
Mg(HCO₃)₂	146.337	2		73.168
Mg(OH) ₂	58.319	2		29.159
MgSO ₄	120.367	2		60.184
Mg ²⁺	24.305	2		12.152
Na ⁺	22.990	1		22.990
Na₂CO₃	105.988	2		52.994
OH ⁻	17.007	1		17.007
SO ₄ ²⁻	96.062	2		48.031

Rapid Mix and Flocculator Design

$$G = \sqrt{\frac{P}{\mu V}} = \sqrt{\frac{\gamma H_L}{t \mu}}$$

$$Gt = 10^4 - 10^5$$

where

G = mixing intensity = root mean square velocity gradient,

P = power,

V = volume,

μ = bulk viscosity,

γ = specific weight of water,

H_L = head loss in mixing zone, and

t = time in mixing zone.

Reel and Paddle

$$P_{\text{BOARD}} = \frac{C_D A_p \rho_f v_p^3}{2}, \text{ where}$$

C_D = drag coefficient = 1.8 for flat blade with a L:W > 20:1,

A_p = area of blade (m^2) perpendicular to the direction of travel through the water,

ρ_f = density of H_2O (kg/m^3),

v_p = relative velocity of paddle (m/sec), and

v = v_{actual} slip coefficient.

slip coefficient = 0.5 – 0.75.

Turbulent Flow Impeller Mixer

$$P = K_T (n)^3 (D_i)^5 \rho_f, \text{ where}$$

K_T = impeller constant (see table),

n = rotational speed (rev/sec), and

D_i = impeller diameter (m).

Values of the Impeller Constant K_T
(Assume Turbulent Flow)

Type of Impeller	K_T
Propeller, pitch of 1, 3 blades	0.32
Propeller, pitch of 2, 3 blades	1.00
Turbine, 6 flat blades, vaned disc	6.30
Turbine, 6 curved blades	4.80
Fan turbine, 6 blades at 45°	1.65
Shrouded turbine, 6 curved blades	1.08
Shrouded turbine, with stator, no baffles	1.12

Note: Constant assumes baffled tanks having four baffles at the tank wall with a width equal to 10% of the tank diameter.

Source: J. H. Rushton, "Mixing of Liquids in Chemical Processing," *Industrial & Engineering Chemistry*, v. 44, no. 12, p. 2931, 1952.

Settling Equations**General Spherical**

$$v_t = \sqrt{\frac{4/3 g (\rho_p - \rho_f) d}{C_D \rho_f}}$$

$$C_D = 24/Re \quad (\text{Laminar; } Re \leq 1.0)$$

$$= 24/Re + 3/(Re)^{1/2} + 0.34 \quad (\text{Transitional})$$

$$= 0.4 \quad (\text{Turbulent; } Re \geq 10^4)$$

$$Re = \text{Reynolds number} = \frac{v_t \rho d}{\mu}, \text{ where}$$

g = gravitational constant,

ρ_p and ρ_f = density of particle and fluid respectively,

d = diameter of sphere,

C_D = spherical drag coefficient,

μ = bulk viscosity of liquid = absolute viscosity, and

v_t = terminal settling velocity.

Stokes' Law

$$v_t = \frac{g (\rho_p - \rho_f) d^2}{18\mu}$$

Filtration Equations

Effective size = d_{10}

Uniformity coefficient = d_{60}/d_{10}

d_x = diameter of particle class for which $x\%$ of sample is less than (units meters or feet).

Head Loss Through Clean Bed**Rose Equation**

Monosized Media

Multisized Media

$$h_f = \frac{1.067 (V_s)^2 L C_D}{g \eta^4 d} \quad h_f = \frac{1.067 (V_s)^2 L}{g \eta^4} \sum \frac{C_{D_{ij}} x_{ij}}{d_{ij}}$$

Carmen-Kozeny Equation

Monosized Media

Multisized Media

$$h_f = \frac{f' L (1 - \eta) V_s^2}{\eta^3 g d_p} \quad h_f = \frac{L (1 - \eta) V_s^2}{\eta^3 g} \sum \frac{f'_{ij} x_{ij}}{d_{ij}}$$

$$f' = \text{friction factor} = 150 \left(\frac{1 - \eta}{Re} \right) + 1.75, \text{ where}$$

h_f = head loss through the cleaner bed (m of H_2O),

L = depth of filter media (m),

η = porosity of bed = void volume/total volume,

V_s = filtration rate = empty bed approach velocity = Q/A_{plan} (m/s), and

g = gravitational acceleration (m/s^2).

$$Re = \text{Reynolds number} = \frac{V_s \rho d}{\mu}$$

d_{ij}, d_p, d = diameter of filter media particles; arithmetic average of adjacent screen openings (m); i = filter media (sand, anthracite, garnet); j = filter media particle size,

x_{ij} = mass fraction of media retained between adjacent sieves,

f'_{ij} = friction factors for each media fraction, and

C_D = drag coefficient as defined in settling velocity equations.

Bed Expansion

Monosized

Multisized

$$L_{fb} = \frac{L_o(1-\eta_o)}{1-\left(\frac{V_B}{V_t}\right)^{0.22}} \quad L_{fb} = L_o(1-\eta_o) \sum \frac{x_{ij}}{1-\left(\frac{V_B}{V_{t,i,j}}\right)^{0.22}}$$

$$\eta_{fb} = \left(\frac{V_B}{V_t}\right)^{0.22}, \text{ where}$$

L_{fb} = depth of fluidized filter media (m),

V_B = backwash velocity (m/s), Q/A_{plan} ,

V_t = terminal setting velocity, and

η_{fb} = porosity of fluidized bed.

L_o = initial bed depth

η_o = initial bed porosity

Clarifier

Overflow rate = $v_o = Q/A_{\text{surface}}$

Weir overflow rate = WOR = $Q/\text{Weir Length}$

Horizontal velocity = $v_h = Q/A_{\text{cross-section}} = Q/A_x$

Typical Primary Clarifier Efficiency Percent Removal

	Overflow rates			
	1,200 (gpd/ft ²)	1,000 (gpd/ft ²)	800 (gpd/ft ²)	600 (gpd/ft ²)
	48.9 (m/d)	40.7 (m/d)	32.6 (m/d)	24.4 (m/d)
Suspended Solids	54%	58%	64%	68%
BOD ₅	30%	32%	34%	36%

Design Data for Clarifiers for Activated-Sludge Systems

Type of Treatment	Overflow rate, m ³ /m ² ·d		Loading kg/m ² ·h		Depth (m)
	Average	Peak	Average	Peak	
Settling following air-activated sludge (excluding extended aeration)	16–32	40–48	3.0–6.0	9.0	3.5–5
Settling following extended aeration	8–16	24–32	1.0–5.0	7.0	3.5–5

Source: Adapted from Metcalf & Eddy, Inc. [5–36]

Design Criteria for Sedimentation Basins

Type of Basin	Overflow Rate (gpd/ft ²)	Detention Time (hr)
Water Treatment		
Presedimentation	300–500	3–4
Clarification following coagulation and flocculation		
1. Alum coagulation	350–550	4–8
2. Ferric coagulation	550–700	4–8
3. Upflow clarifiers		
a. Ground water	1,500–2,200	1
b. Surface water	1,000–1,500	4
Clarification following lime-soda softening		
1. Conventional	550–1,000	2–4
2. Upflow clarifiers		
a. Ground water	1,000–2,500	1
b. Surface water	1,000–1,800	4
Wastewater Treatment		
Primary clarifiers	600–1,200	2
Fixed film reactors		
1. Intermediate and final clarifiers	400–800	2
Activated sludge	800–1,200	2
Chemical precipitation	800–1,200	2

Weir Loadings

1. Water Treatment—weir overflow rates should not exceed 20,000 gpd/ft
2. Wastewater Treatment
 - a. Flow ≤ 1 MGD: weir overflow rates should not exceed 10,000 gpd/ft
 - b. Flow > 1 MGD: weir overflow rates should not exceed 15,000 gpd/ft

Horizontal Velocities

1. Water Treatment—horizontal velocities should not exceed 0.5 fpm
2. Wastewater Treatment—no specific requirements (use the same criteria as for water)

Dimensions

1. Rectangular tanks
 - a. Length:Width ratio = 3:1 to 5:1
 - b. Basin width is determined by the scraper width (or multiples of the scraper width)
 - c. Bottom slope is set at 1%
 - d. Minimum depth is 10 ft
2. Circular Tanks
 - a. Diameters up to 200 ft
 - b. Diameters must match the dimensions of the sludge scraping mechanism
 - c. Bottom slope is less than 8%
 - d. Minimum depth is 10 ft

Length:Width Ratio

Clarifier	3:1 to 5:1
Filter bay	1.2:1 to 1.5:1
Chlorine contact chamber	20:1 to 50:1

Activated Carbon Adsorption

Freundlich Isotherm

$$\frac{x}{m} = X = KC_e^{1/n}, \text{ where}$$

- x = mass of solute adsorbed,
 m = mass of adsorbent,
 X = mass ratio of the solid phase—that is, the mass of adsorbed solute per mass of adsorbent,
 C_e = equilibrium concentration of solute, mass/volume, and
 K, n = experimental constants.

Linearized Form

$$\ln \frac{x}{m} = 1/n \ln C_e + \ln K$$

For linear isotherm, $n = 1$

Langmuir Isotherm

$$\frac{x}{m} = X = \frac{aKC_e}{1 + KC_e}, \text{ where}$$

- a = mass of adsorbed solute required to saturate completely a unit mass of adsorbent, and
 K = experimental constant.

Linearized Form

$$\frac{m}{x} = \frac{1}{a} + \frac{1}{aK} \frac{1}{C_e}$$

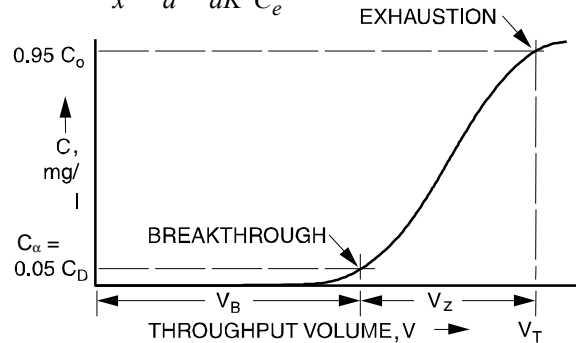

Depth of Sorption Zone

$$Z_s = Z \left[\frac{V_Z}{V_T - 0.5V_Z} \right], \text{ where}$$

- $V_Z = V_T - V_B$
 Z_s = depth of sorption zone,
 Z = total carbon depth,
 V_T = total volume treated at exhaustion ($C = 0.95 C_o$),
 V_B = total volume at breakthrough ($C = C_\alpha = 0.05 C_o$), and
 C_o = concentration of contaminant in influent.

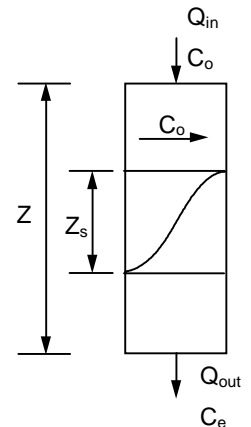

Reverse Osmosis

Osmotic Pressure of Solutions of Electrolytes

$$\pi = \phi v \frac{n}{V} RT, \text{ where}$$

- π = osmotic pressure,
 ϕ = osmotic coefficient,
 v = number of ions formed from one molecule of electrolyte,
 n = number of moles of electrolyte,
 V = volume of solvent,
 R = universal gas constant, and
 T = absolute pressure.

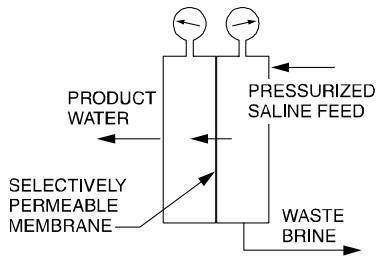

A CONTINUOUS-FLOW REVERSE OSMOSIS UNIT

Water Flux

$$J_w = W_p \times (\Delta P - \Delta \pi), \text{ where}$$

J_w = water flux through the membrane [$\text{gmol}/(\text{cm}^2 \cdot \text{s})$],

W_p = coefficient of water permeation, a characteristic of the particular membrane [$\text{gmol}/(\text{cm}^2 \cdot \text{s} \cdot \text{atm})$],

ΔP = pressure differential across membrane = $P_{\text{in}} - P_{\text{out}}$ (atm), and

$\Delta \pi$ = osmotic pressure differential across membrane $\pi_{\text{in}} - \pi_{\text{out}}$ (atm).

Salt Flux through the Membrane

$$J_s = (D_s K_s / \Delta Z)(C_{\text{in}} - C_{\text{out}}), \text{ where}$$

J_s = salt flux through the membrane [$\text{gmol}/(\text{cm}^2 \cdot \text{s})$],

D_s = diffusivity of the solute in the membrane (cm^2/s),

K_s = solute distribution coefficient (dimensionless),

C = concentration (gmol/cm^3),

ΔZ = membrane thickness (cm), and

$$J_s = K_p \times (C_{\text{in}} - C_{\text{out}})$$

K_p = membrane solute mass transfer coefficient =

$$D_s K_s / \Delta Z \text{ (L/t, cm/s)}.$$

Ultrafiltration

$$J_w = \frac{\epsilon r^2 \int \Delta P}{8\mu\delta}, \text{ where}$$

ϵ = membrane porosity,

r = membrane pore size,

ΔP = net transmembrane pressure,

μ = viscosity,

δ = membrane thickness, and

J_w = volumetric flux (m/s).

Electrodialysis

In n Cells, the Required Current Is:

$$I = (FQN/n) \times (E_1 / E_2), \text{ where}$$

I = current (amperes),

F = Faraday's constant = 96,487 C/g-equivalent,

Q = flow rate (L/s),

N = normality of solution (g-equivalent/L),

n = number of cells between electrodes,

E_1 = removal efficiency (fraction), and

E_2 = current efficiency (fraction).

Voltage

$$E = IR, \text{ where}$$

E = voltage requirement (volts), and

R = resistance through the unit (ohms).

Required Power

$$P = I^2 R \text{ (watts)}$$

Air Stripping

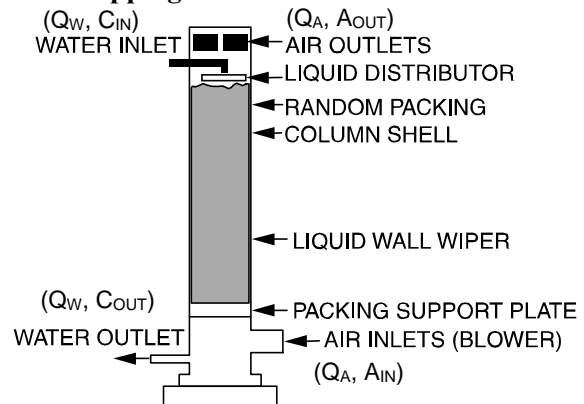

$$A_{\text{out}} = H' C_{\text{in}}$$

$$Q_w [C_{\text{in}}] = Q_A [H' C_{\text{in}}]$$

$$Q_w = Q_A [H']$$

$$H' (Q_A / Q_w) = 1$$

where

A_{out} = concentration in the effluent air,

H = Henry's Law constant,

H' = H/RT = dimensionless Henry's Law constant,

R = universal gas constant,

Q_w = water flow rate (m^3/s),

Q_A = air flow rate (m^3/s),

A = concentration of contaminant in air (kmol/m^3), and

C = concentration of contaminants in water (kmol/m^3).

Stripper Packing Height = Z

$$Z = \text{HTU} \times \text{NTU}$$

$$\text{NTU} = \left(\frac{R}{R-1} \right) \ln \left(\frac{(C_{in}/C_{out})(R-1)+1}{R} \right)$$

NTU = number of transfer units

where

R = stripping factor $H'(Q_A / Q_W)$ (dimensionless),

C_{in} = concentration in the effluent water (kmol/m^3), and

C_{out} = concentration in the effluent water (kmol/m^3).

$$\text{HTU} = \text{Height of Transfer Units} = \frac{L}{M_W K_L a},$$

where

L = liquid molar loading rate [$\text{kmol}/(\text{s} \cdot \text{m}^2)$],

M_W = molar density of water ($55.6 \text{ kmol}/\text{m}^3 = 3.47 \text{ lbmol}/\text{ft}^3$), and

$K_L a$ = overall transfer rate constant (s^{-1}).

Environmental Microbiology**BOD Exertion**

$$y_t = L (1 - e^{-kt})$$

where

k = reaction rate constant (base e , days^{-1}),

L = ultimate BOD (mg/L),

t = time (days), and

y_t = the amount of BOD exerted at time t (mg/L).

Monod Kinetics

$$\mu = \mu_{max} \frac{S}{K_x + S}, \text{ where}$$

μ = specific growth rate (time^{-1}),

μ_{max} = maximum specific growth rate (time^{-1}),

S = concentration of substrate in solution (mass/unit volume), and

K_x = half-velocity constant = half-saturation constant (i.e., substrate concentration at which the specific growth rate is one-half μ_{max}) (mass/unit volume).

Half-Life of a Biologically Degraded Contaminant**Assuming First-Order Rate Constant**

$$k = \frac{0.693}{t_{1/2}}, \text{ where}$$

$t_{1/2}$ = half-life (days).

Activated Sludge

$$X_A = \frac{\theta_c Y (S_o - S_e)}{\theta (1 + k_d \theta_c)}, \text{ where}$$

X_A = biomass concentration in aeration tank (MLSS or MLVSS kg/m^3);

S_o = influent BOD or COD concentration (kg/m^3);

S_e = effluent BOD or COD concentration (kg/m^3);

k_d = microbial death ratio; kinetic constant; day^{-1} ; typical range 0.1–0.01, typical domestic wastewater value = 0.05 day^{-1} ;

Y = yield coefficient $\text{Kg biomass}/\text{Kg BOD consumed}$; range 0.4–1.2; and

θ = hydraulic residence time.

$$\theta_c = \text{Solids residence time} = \frac{V_A X_A}{Q_w X_w + Q_e X_e}$$

$$\text{Sludge flow rate: } Q_s = \frac{M(100)}{\rho_s (\% \text{ solids})}$$

$$\text{Solids loading rate} = Q X / A$$

For activated sludge secondary clarifier $Q = Q_o + Q_R$

Organic loading rate (volumetric) = $Q_o S_o / V$

Organic loading rate (F:M) = $Q_o S_o / (V_A X_A)$

Organic loading rate (surface area) = $Q_o S_o / A_M$

$$\text{SVI} = \frac{\text{Sludge volume after settling (mL/L)} * 1,000}{\text{MLSS (mg/L)}}$$

Steady State Mass Balance for Secondary Clarifier:

$$(Q_o + Q_R) X_A = Q_e X_e + Q_R X_w + Q_w X_w$$

A = surface area of unit,

A_M = surface area of media in fixed-film reactor,

A_x = cross-sectional area of channel,

M = sludge production rate (dry weight basis),

Q_o = flow rate, influent

Q_e = effluent flow rate,

Q_w = waste sludge flow rate,

ρ_s = wet sludge density,

R = recycle ratio = Q_R / Q_o

Q_R = recycle flow rate = $Q_o R$,

X_e = effluent suspended solids concentration,

X_w = waste sludge suspended solids concentration,

V = tank volume,

V_A = aeration basin volume,

Q = flow rate.

**DESIGN AND OPERATIONAL PARAMETERS FOR ACTIVATED-SLUDGE
TREATMENT OF MUNICIPAL WASTEWATER**

Type of Process	Mean cell residence time (θ_c , d)	Food-to-mass ratio (kg BOD ₅ /kg MLSS)	Volumetric loading (V_L kg BOD ₅ /m ³)	Hydraulic retention time in aeration basin (θ , h)	Mixed liquor suspended solids (MLSS, mg/L)	Recycle ratio (Q_r/Q)	Flow regime*	BOD ₅ removal efficiency (%)	Air supplied (m ³ /kg BOD ₅)
Tapered aeration	5–15	0.2–0.4	0.3–0.6	4–8	1,500–3,000	0.25–0.5	PF	85–95	45–90
Conventional	4–15	0.2–0.4	0.3–0.6	4–8	1,500–3,000	0.25–0.5	PF	85–95	45–90
Step aeration	4–15	0.2–0.4	0.6–1.0	3–5	2,000–3,500	0.25–0.75	PF	85–95	45–90
Completely mixed	4–15	0.2–0.4	0.8–2.0	3–5	3,000–6,000	0.25–1.0	CM	85–95	45–90
Contact stabilization	4–15	0.2–0.6	1.0–1.2			0.25–1.0			45–90
Contact basin				0.5–1.0	1,000–3,000		PF	80–90	
Stabilization basin				4–6	4,000–10,000		PF		
High-rate aeration	4–15	0.4–1.5	1.6–16	0.5–2.0	4,000–10,000	1.0–5.0	CM	75–90	25–45
Pure oxygen	8–20	0.2–1.0	1.6–4	1–3	6,000–8,000	0.25–0.5	CM	85–95	
Extended aeration	20–30	0.05–0.15	0.16–0.40	18–24	3,000–6,000	0.75–1.50	CM	75–90	90–125

Source: Adapted from Metcalf & Eddy, Inc. [5-36] and Steele and McGhee [5-50].

*PF = plug flow, CM = completely mixed.

Facultative Pond

BOD Loading

$$\text{Mass (lb/day)} = \text{Flow (MGD)} \times \text{Concentration (mg/L)} \times 8.34(\text{lb/MGal})/(\text{mg/L})$$

$$\text{Total System} \leq 35 \text{ pounds BOD}_5/\text{acre/day}$$

$$\text{Minimum} = 3 \text{ ponds}$$

$$\text{Depth} = 3\text{--}8 \text{ ft}$$

$$\text{Minimum } t = 90\text{--}120 \text{ days}$$

Biotower

Fixed-Film Equation without Recycle

$$\frac{S_e}{S_o} = e^{-kD/q^n}$$

Fixed-Film Equation with Recycle

$$\frac{S_e}{S_a} = \frac{e^{-kD/q^n}}{(1+R) - R(e^{-kD/q^n})}$$

$$S_a = \frac{S_o + RS_e}{1+R}, \text{ where}$$

S_e = effluent BOD₅ (mg/L),

S_o = influent BOD₅ (mg/L),

D = depth of biotower media (m),

q = hydraulic loading (m³/m²/min),
= $(Q_o + RQ_o)/A_{\text{plan}}$ (with recycle),

k = treatability constant; functions of wastewater and medium (min⁻¹); range 0.01–0.1; for municipal wastewater and modular plastic media 0.06 min⁻¹ @ 20°C,

$$k_T = k_{20}(1.035)^{T-20},$$

n = coefficient relating to media characteristics; modular plastic, $n = 0.5$,

R = recycle ratio = Q_o / Q_R , and

Q_R = recycle flow rate.

Anaerobic Digester

Design parameters for anaerobic digesters

Parameter	Standard-rate	High-rate
Solids retention time, d	30–90	10–20
Volatile solids loading, kg/m ³ /d	0.5–1.6	1.6–6.4
Digested solids concentration, %	4–6	4–6
Volatile solids reduction, %	35–50	45–55
Gas production (m ³ /kg VSS added)	0.5–0.55	0.6–0.65
Methane content, %	65	65

Source: Adapted from Metcalf & Eddy, Inc. [5-36]

Standard Rate

$$\text{Reactor Volume} = \frac{V_1 + V_2}{2} t_r + V_2 t_s$$

High Rate

First stage

$$\text{Reactor Volume} = V_1 t_r$$

Second Stage

$$\text{Reactor Volume} = \frac{V_1 + V_2}{2} t_t + V_2 t_s, \text{ where}$$

V_1 = raw sludge input (m³/day),

V_2 = digested sludge accumulation (m³/day),

t_r = time to react in a high-rate digester = time to react and thicken in a standard-rate digester,

t_t = time to thicken in a high-rate digester, and

t_s = storage time.

Aerobic Digestion

Tank Volume

$$V = \frac{Q_i(X_i + FS_i)}{X_d(K_d P_v + 1/\theta_c)}, \text{ where}$$

V = volume of aerobic digester (ft³),

- Q_i = influent average flowrate to digester (ft³/d),
- X_i = influent suspended solids (mg/L),
- F = fraction of the influent BOD₅ consisting of raw primary sludge (expressed as a decimal),
- S_i = influent BOD₅ (mg/L),
- X_d = digester suspended solids (mg/L),
- K_d = reaction-rate constant (d⁻¹),
- P_v = volatile fraction of digester suspended solids (expressed as a decimal), and
- θ_c = solids retention time (sludge age) (d).

where

- C = steady-state concentration at a point (x, y, z) (µg/m³),
- Q = emissions rate (µg/s),
- σ_y = horizontal dispersion parameter (m),
- σ_z = vertical dispersion parameter (m),
- μ = average wind speed at stack height (m/s),
- y = horizontal distance from plume centerline (m),
- z = vertical distance from ground level (m),
- H = effective stack height (m) = $h + \Delta h$
where h = physical stack height
 Δh = plume rise, and
- x = downwind distance along plume centerline (m).

AIR POLLUTION

For information on Ideal Gas Law equations refer to the THERMODYNAMICS Section.

Atmospheric Dispersion Modeling (Gaussian)

σ_y and σ_z as a function of downwind distance and stability class, see following figures.

$$C = \frac{Q}{2\pi\mu\sigma_y\sigma_z} \exp\left(-\frac{1}{2} \frac{y^2}{\sigma_y^2}\right) \left[\exp\left(-\frac{1}{2} \frac{(z-H)^2}{\sigma_z^2}\right) + \exp\left(-\frac{1}{2} \frac{(z+H)^2}{\sigma_z^2}\right) \right]$$

Concentration downwind from elevated source

$$C_{(max)} = \frac{Q}{\pi\mu\sigma_y\sigma_z} e^{\left(-\frac{1}{2} \frac{H^2}{\sigma_z^2}\right)} \text{ at } \sigma_z = (H/2)^{1/2}$$

where variables as previous except

$C_{(max)}$ = maximum ground-level concentration.

Atmospheric Stability Under Various Conditions

Surface Wind Speed ^a (m/s)	Day			Night	
	Solar Insolation			Cloudiness ^e	
	Strong ^b	Moderate ^c	Slight ^d	Cloudy (≥4/8)	Clear (≤3/8)
<2	A	A-B ^f	B	E	F
2-3	A-B	B	C	E	F
3-5	B	B-C	C	D	E
5-6	C	C-D	D	D	D
>6	C	D	D	D	D

Notes:

- a. Surface wind speed is measured at 10 m above the ground.
- b. Corresponds to clear summer day with sun higher than 60° above the horizon.
- c. Corresponds to a summer day with a few broken clouds, or a clear day with sun 35-60° above the horizon.
- d. Corresponds to a fall afternoon, or a cloudy summer day, or clear summer day with the sun 15-35°.
- e. Cloudiness is defined as the fraction of sky covered by the clouds.
- f. For A-B, B-C, or C-D conditions, average the values obtained for each.

- * A = Very unstable D = Neutral
- B = Moderately unstable E = Slightly stable
- C = Slightly unstable F = Stable

Regardless of wind speed, Class D should be assumed for overcast conditions, day or night.

SOURCE: Turner, 1970.

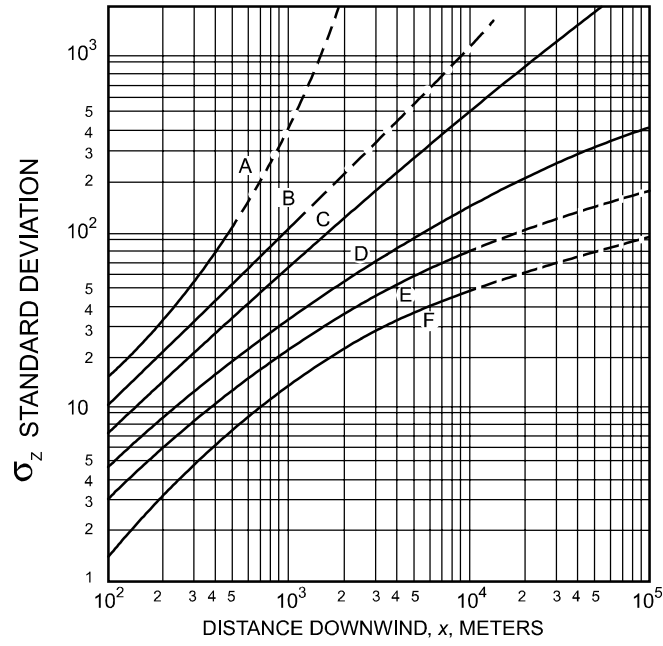

VERTICAL STANDARD DEVIATIONS OF A PLUME

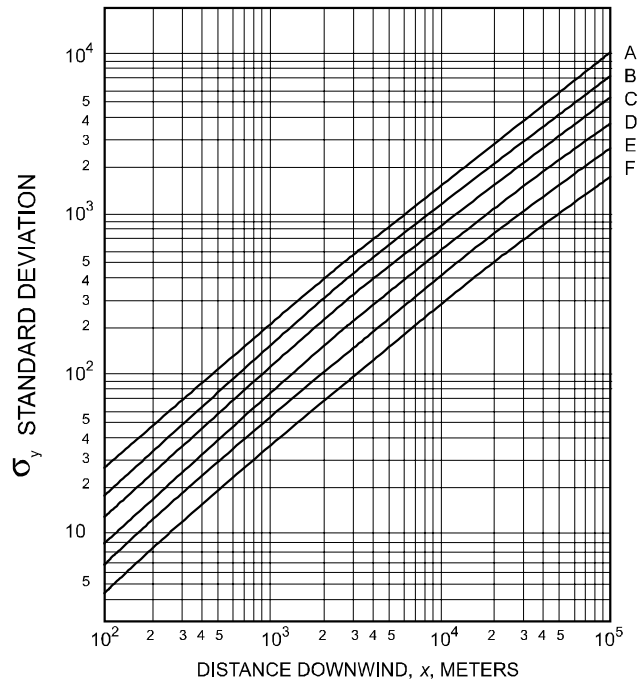

HORIZONTAL STANDARD DEVIATIONS OF A PLUME

- A - EXTREMELY UNSTABLE
- B - MODERATELY UNSTABLE
- C - SLIGHTLY UNSTABLE
- D - NEUTRAL
- E - SLIGHTLY STABLE
- F - MODERATELY STABLE

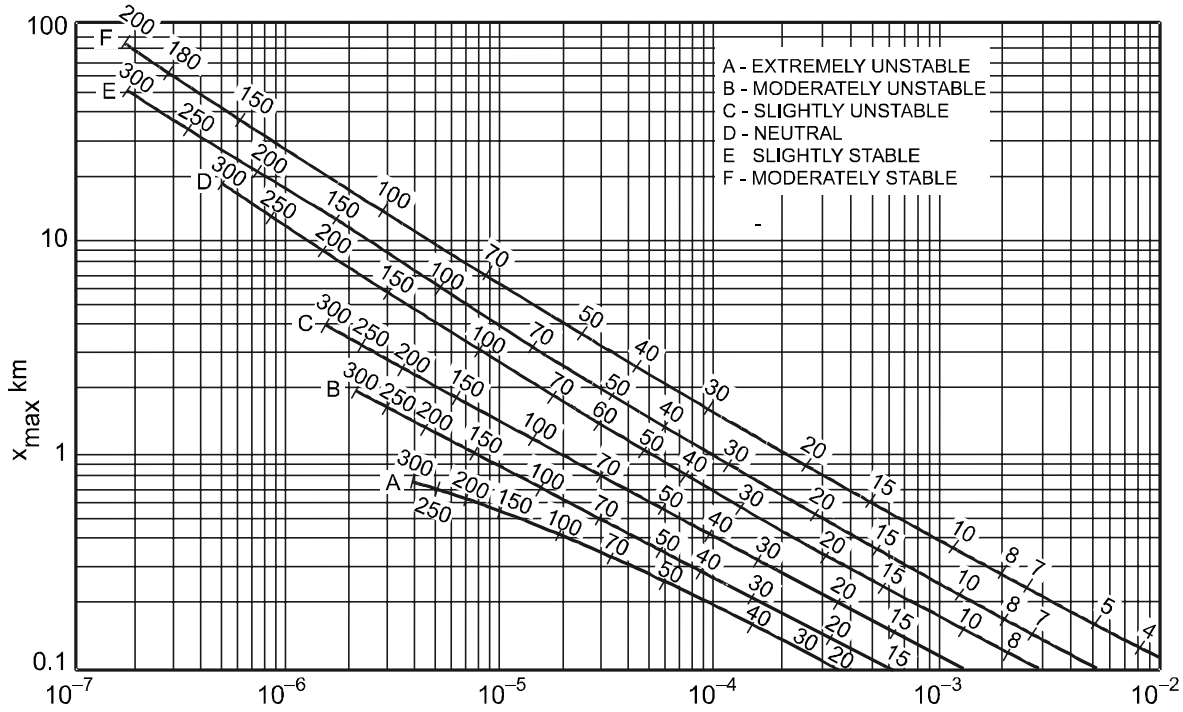

$$\left(\frac{C_u}{Q}\right)_{\max}, \text{m}^{-2}$$

NOTE: Effective stack height shown on curves numerically.

SOURCE: Turner, D. B., "Workbook of Atmospheric Dispersion Estimates," Washington, DC, U.S. Environmental Protection Agency, 1970.

$$\left(\frac{C_u}{Q}\right)_{\max} = e^{[a + b \ln H + c (\ln H)^2 + d (\ln H)^3]}$$

H = effective stack height, stack height + plume rise, m

Values of Curve-Fit Constants for Estimating $(Cu/Q)_{\max}$ from H as a Function of Atmospheric Stability

Stability	Constants			
	a	b	c	d
A	-1.0563	-2.7153	0.1261	0
B	-1.8060	-2.1912	0.0389	0
C	-1.9748	-1.9980	0	0
D	-2.5302	-1.5610	-0.0934	0
E	-1.4496	-2.5910	0.2181	-0.0343
F	-1.0488	-3.2252	0.4977	-0.0765

Adapted from Ranchoux, 1976.

Incineration

$$DRE = \frac{W_{in} - W_{out}}{W_{in}} \times 100\% , \text{ where}$$

DRE = destruction and removal efficiency (%),

W_{in} = mass feed rate of a particular POHC (kg/h or lb/h), and

W_{out} = mass emission rate of the same POHC (kg/h or lb/h).

$$CE = \frac{CO_2}{CO_2 + CO} \times 100\% , \text{ where}$$

CO_2 = volume concentration (dry) of CO_2 (parts per million, volume, ppmv),

CO = volume concentration (dry) of CO (ppmv),

CE = combustion efficiency, and

POHC = principal organic hazardous contaminant.

Cyclone

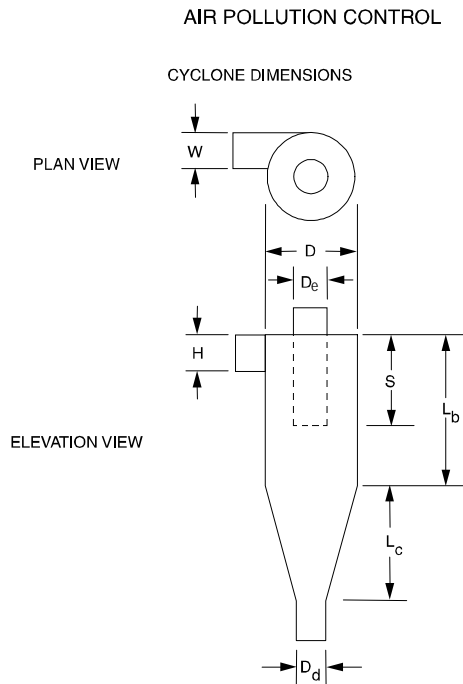

Cyclone Ratio of Dimensions to Body Diameter

Dimension		High Efficiency	Conventional	High Throughput
Inlet height	H	0.44	0.50	0.80
Inlet width	W	0.21	0.25	0.35
Body length	L_b	1.40	1.75	1.70
Cone length	L_c	2.50	2.00	2.00
Vortex finder length	S	0.50	0.60	0.85
Gas exit diameter	D_e	0.40	0.50	0.75
Dust outlet diameter	D_d	0.40	0.40	0.40

Cyclone Effective Number of Turns Approximation

$$N_e = \frac{1}{H} \left[L_b + \frac{L_c}{2} \right], \text{ where}$$

- N_e = number of effective turns gas makes in cyclone,
- H = inlet height of cyclone (m),
- L_b = length of body cyclone (m), and
- L_c = length of cone of cyclone (m).

Cyclone 50% Collection Efficiency for Particle Diameter

$$d_{pc} = \left[\frac{9\mu W}{2\pi N_e v_i (\rho_p - \rho_g)} \right]^{0.5}, \text{ where}$$

- d_{pc} = diameter of particle that is collected with 50% efficiency (m),
- μ = viscosity of gas (kg/m-s),
- W = inlet width of cyclone (m),
- N_e = number of effective turns gas makes in cyclone,
- v_i = inlet velocity into cyclone (m/s),
- ρ_p = density of particle (kg/m³), and
- ρ_g = density of gas (kg/m³).

Cyclone Collection Efficiency

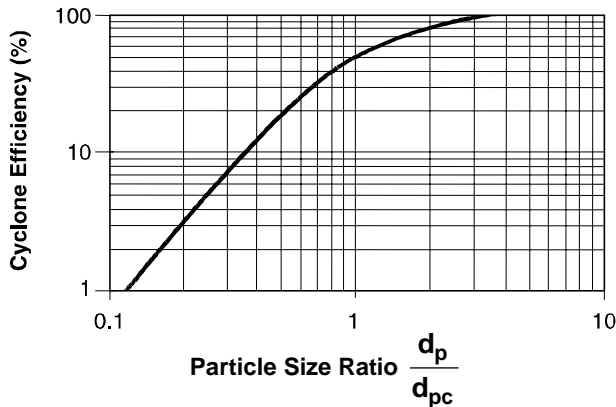

Cyclone Collection (Particle Removal) Efficiency

$$\eta = \frac{1}{1 + (d_{pc}/d_p)^2}, \text{ where}$$

- d_{pc} = diameter of particle collected with 50% efficiency,
- d_p = diameter of particle of interest, and
- η = fractional particle collection efficiency.

Bag House

Air-to-Cloth Ratio for Baghouses

Dust	Shaker/Woven	Pulse
	Reverse Air/Woven (m ³ /min/m ²)	Jet/Felt (m ³ /min/m ²)
alumina	0.8	2.4
asbestos	0.9	3.0
bauxite	0.8	2.4
carbon black	0.5	1.5
coal	0.8	2.4
cocoa	0.8	3.7
clay	0.8	2.7
cement	0.6	2.4
cosmetics	0.5	3.0
enamel frit	0.8	2.7
feeds, grain	1.1	4.3
feldspar	0.7	2.7
fertilizer	0.9	2.4
flour	0.9	3.7
fly ash	0.8	1.5
graphite	0.6	1.5
gypsum	0.6	3.0
iron ore	0.9	3.4
iron oxide	0.8	2.1
iron sulfate	0.6	1.8
lead oxide	0.6	1.8
leather dust	1.1	3.7
lime	0.8	3.0
limestone	0.8	2.4
mica	0.8	2.7
paint pigments	0.8	2.1
paper	1.1	3.0
plastics	0.8	2.1
quartz	0.9	2.7
rock dust	0.9	2.7
sand	0.8	3.0
sawdust (wood)	1.1	3.7
silica	0.8	2.1
slate	1.1	3.7
soap detergents	0.6	1.5
spices	0.8	3.0
starch	0.9	2.4
sugar	0.6	2.1
talc	0.8	3.0
tobacco	1.1	4.0
zinc oxide	0.6	1.5

U.S. EPA OAQPS Control Cost Manual. 4th ed., EPA 450/3-90-006 (NTIS PB 90-169954). January 1990

Electrostatic Precipitator Efficiency

Deutsch-Anderson equation:

$$\eta = 1 - e^{(-wA/Q)}, \text{ where}$$

η = fractional collection efficiency,

W = terminal drift velocity,

A = total collection area, and

Q = volumetric gas flow rate.

Note that any consistent set of units can be used for W , A , and Q (for example, ft/min, ft², and ft³/min).

NOISE POLLUTION

$$\text{SPL (dB)} = 10 \log_{10} \left(P^2 / P_0^2 \right)$$

$$\text{SPL}_{\text{total}} = 10 \log_{10} \sum 10^{\text{SPL}/10}$$

Point Source Attenuation

$$\Delta \text{SPL (dB)} = 10 \log_{10} (r_1/r_2)^2$$

Line Source Attenuation

$$\Delta \text{SPL (dB)} = 10 \log_{10} (r_1/r_2)$$

where

SPL (dB) = sound pressure level, measured in decibels

P = sound pressure (Pa)

P_0 = reference sound pressure (2×10^{-5} Pa)

$\text{SPL}_{\text{total}}$ = sum of multiple sources

$\Delta \text{SPL (dB)}$ = change in sound pressure level with distance

r_1 = distance from source to receptor Δt at point 1

r_2 = distance from source to receptor Δt at point 2

RADIATION HALF-LIFE

$$N = N_0 e^{-0.693t/\tau}, \text{ where}$$

N_0 = original number of atoms,

N = final number of atoms,

t = time, and

τ = half-life.

$$\text{Flux at distance 2} = (\text{Flux at distance 1}) (r_1/r_2)^2$$

RISK ASSESSMENT

Risk is a product of toxicity and exposure.

Risk assessment process

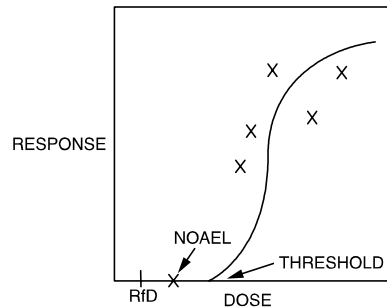
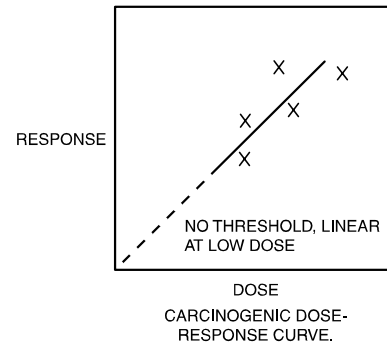

Dose is expressed as the mass intake of the chemical normalized to the body weight of the exposed individual and the time period of exposure.

NOAEL = No Observable Adverse Effect Level. The dose below which there are no harmful effects.

CSF = Cancer Slope Factor. Determined from the dose-response curve for carcinogenic materials.

Exposure and Intake Rates

Soil Ingestion Rate

100 mg/day (>6 years old)

200 mg/day (children 1 to 6 years old)

Exposure Duration

30 years at one residence (adult)

6 years (child)

Body Mass

70 kg (adult)

10 kg (child)

Averaging Period

non-carcinogens, actual exposure duration

carcinogens, 70 years

Water Consumption Rate

2.0 L/day (adult)

1.0 L/day (child)

Inhalation Rate

0.83 m³/hr (adult)

0.46 m³/hr (child)

Determined from the Noncarcinogenic Dose-Response Curve Using NOAEL

$$\text{RfD} = \text{NOAEL}/\text{a safety factor}$$

Exposure assessment calculates the actual or potential dose that an exposed individual receives and delineates the affected population by identifying possible exposure paths.

$$\text{Daily Dose (mg/kg-day)} = \frac{(C)(I)(EF)(ED)(AF)}{(AT)(BW)}, \text{ where}$$

- C = concentration (mass/volume),
 I = intake rate (volume/time),
 EF = exposure frequency (time/time),
 ED = exposure duration (time),
 AF = absorption factor (mass/mass),
 AT = averaging time (time),
 BW = body weight (mass), and

$LADD$ = lifetime average daily dose (daily dose, in mg/kg – d, over an assumed 70-year lifetime).

Risk

Risk characterization estimates the probability of adverse incidence occurring under conditions identified during exposure assessment.

For carcinogens the added risk of cancer is calculated as follows:

$$\text{Risk} = \text{dose} \times \text{toxicity} = \text{daily dose} \times \text{CSF}$$

For noncarcinogens, a hazard index (HI) is calculated as follows:

$$\text{HI} = \text{intake rate}/\text{RfD}$$

Risk Management

Carcinogenic risk between 10^{-4} and 10^{-6} is deemed acceptable by the U.S. EPA.

For noncarcinogens, a HI greater than 1 indicates that an unacceptable risk exists.

SAMPLING AND MONITORING

For information about Student t-Distribution, Standard Deviation, and Confidence Intervals, refer to the MATHEMATICS section.

FATE AND TRANSPORT

Partition Coefficients

Octanol-Water Partition Coefficient

The ratio of a chemical's concentration in the octanol phase to its concentration in the aqueous phase of a two-phase octanol-water system.

$$K_{ow} = C_o / C_w, \text{ where}$$

- C_o = concentration of chemical in octanol phase (mg/L or $\mu\text{g/L}$) and
 C_w = concentration of chemical in aqueous phase (mg/L or $\mu\text{g/L}$).

Soil-Water Partition Coefficient $K_{sw} = K_p$

$$K_{sw} = X/C, \text{ where}$$

X = concentration of chemical in soil (ppb or $\mu\text{g/kg}$), and

C = concentration of chemical in water (ppb or $\mu\text{g/kg}$).

Organic Carbon Partition Coefficient K_{oc}

$$K_{oc} = C_{soil} / C_{water}, \text{ where}$$

C_{soil} = concentration of chemical in organic carbon component of soil (μg adsorbed/kg organic C, or ppb), and

C_{water} = concentration of chemical in water (ppb or $\mu\text{g/kg}$)

$$K_{sw} = K_{oc} f_{oc}, \text{ where}$$

f_{oc} = fraction of organic carbon in the soil (dimensionless).

Bioconcentration Factor (BCF)

The amount of a chemical to accumulate in aquatic organisms.

$$\text{BCF} = C_{org} / C, \text{ where}$$

C_{org} = equilibrium concentration in organism (mg/kg or ppm), and

C = concentration in water (ppm).

Retardation Factor = R

$$R = 1 + (\rho/\eta)K_d, \text{ where}$$

ρ = bulk density,

η = porosity, and

K_d = distribution coefficient.

LANDFILL

Gas Flux

$$N_A = \frac{D\eta^{4/3}(C_{A_{am}} - C_{A_{fill}})}{L}, \text{ where}$$

N_A = gas flux of compound A, $\text{g/cm}^2 \cdot \text{s}$ ($\text{lb} \cdot \text{mol}/\text{ft}^2 \cdot \text{d}$),

$C_{A_{am}}$ = concentration of compound A at the surface of the landfill cover, g/cm^3 ($\text{lb} \cdot \text{mol}/\text{ft}^3$),

$C_{A_{fill}}$ = concentration of compound A at the bottom of the landfill cover, g/cm^3 ($\text{lb} \cdot \text{mol}/\text{ft}^3$), and

L = depth of the landfill cover, cm (ft).

Typical values for the coefficient of diffusion for methane and carbon dioxide are $0.20 \text{ cm}^2/\text{s}$ ($18.6 \text{ ft}^2/\text{d}$) and $0.13 \text{ cm}^2/\text{s}$ ($12.1 \text{ ft}^2/\text{d}$), respectively.

D = diffusion coefficient, cm^2/s (ft^2/d),

η_{gas} = gas-filled porosity, cm^3/cm^3 (ft^3/ft^3), and

η = total porosity, cm^3/cm^3 (ft^3/ft^3)

Break-Through Time for Leachate to Penetrate a Clay Liner

$$t = \frac{d^2 \eta}{K(d+h)}, \text{ where}$$

- t = breakthrough time (yr),
- d = thickness of clay liner (ft),
- η = effective porosity,
- K = coefficient of permeability (ft/yr), and
- h = hydraulic head (ft).

Typical effective porosity values for clays with a coefficient of permeability in the range of 10^{-6} to 10^{-8} cm/s vary from 0.1 to 0.3.

Soil Landfill Cover Water Balance

$$\Delta S_{LC} = P - R - ET - PER_{sw}, \text{ where}$$

- ΔS_{LC} = change in the amount of water held in storage in a unit volume of landfill cover (in.),
- P = amount of precipitation per unit area (in.),

- R = amount of runoff per unit area (in.),
- ET = amount of water lost through evapotranspiration per unit area (in.), and
- PER_{sw} = amount of water percolating through the unit area of landfill cover into compacted solid waste (in.).

Effect of Overburden Pressure

$$SW_p = SW_i + \frac{p}{a + bp}$$

where

- SW_p = specific weight of the waste material at pressure p (lb/yd³) (typical 1,750 to 2,150),
- SW_i = initial compacted specific weight of waste (lb/yd³) (typical 1,000),
- p = overburden pressure (lb/in²),
- a = empirical constant (yd³/lb)(lb/in²), and
- b = empirical constant (yd³/lb).

Data Quality Objectives (DQO) for Sampling Soils and Solids

Investigation Type	Confidence Level (1- α) (%)	Power (1- β) (%)	Minimum Detectable Relative Difference (%)
Preliminary site investigation	70-80	90-95	10-30
Emergency clean-up	80-90	90-95	10-20
Planned removal and remedial response operations	90-95	90-95	10-20

EPA Document "EPA/600/8-89/046" *Soil Sampling Quality Assurance User's Guide*, Chapter 7.

Confidence level: $1 - (\text{Probability of a Type I Error}) = 1 - \alpha = \text{size probability of not making a Type I error}$

Power = $1 - (\text{Probability of a Type II error}) = 1 - \beta = \text{probability of not making a Type II error}$.

$$CV = (100 * s) / \bar{x}$$

CV = coefficient of variation

s = standard deviation of sample

\bar{x} = sample average

Minimum Detectable Relative Difference = Relative increase over background $[100 (\mu_s - \mu_B) / \mu_B]$ to be detectable with a probability (1- β)

Number of samples required in a one-sided one-sample t-test to achieve a minimum detectable relative difference at confidence level $(1-\alpha)$ and power of $(1-\beta)$

Coefficient of Variation (%)	Power (%)	Confidence Level (%)	Minimum Detectable Relative Difference (%)				
			5	10	20	30	40
15	95	99	145	39	12	7	5
		95	99	26	8	5	3
		90	78	21	6	3	3
		80	57	15	4	2	2
	90	99	120	32	11	6	5
		95	79	21	7	4	3
		90	60	16	5	3	2
		80	41	11	3	2	1
	80	99	94	26	9	6	5
		95	58	16	5	3	3
		90	42	11	4	2	2
		80	26	7	2	2	1
25	95	99	397	102	28	14	9
		95	272	69	19	9	6
		90	216	55	15	7	5
		80	155	40	11	5	3
	90	99	329	85	24	12	8
		95	272	70	19	9	6
		90	166	42	12	6	4
		80	114	29	8	4	3
	80	99	254	66	19	10	7
		95	156	41	12	6	4
		90	114	30	8	4	3
		80	72	19	5	3	2
35	95	99	775	196	42	25	15
		95	532	134	35	17	10
		90	421	106	28	13	8
		80	304	77	20	9	6
	90	99	641	163	43	21	13
		95	421	107	28	14	8
		90	323	82	21	10	6
		80	222	56	15	7	4
	80	99	495	126	34	17	11
		95	305	78	21	10	7
		90	222	57	15	7	5
		80	140	36	10	5	3

Reactivity group																																										
No.	Name																																									
1	Acids, minerals, non-oxidizing	1																																								
2	Acids, minerals, oxidizing		2																																							
3	Acids, organic			G H	3																																					
4	Alcohols & glycols	H	H F	H P		4																																				
5	Aldehydes	H P	H F	H P			5																																			
6	Amides	H	H GT					6																																		
7	Amines, aliphatic & aromatic	H	H GT	H	H				7																																	
8	Azo compounds, diazo comp, & hydrazines	H G	H GT	H G	H G	H				8																																
9	Carbamates	H G	H GT								H G	9																														
10	Caustics	H	H	H	H						H G		10																													
11	Cyanides	GT GF	GT GF	GT GF						G					11																											
12	Dithiocarbonates	H GF F	H GF F	H GF GT		GF GT			U	H G						12																										
13	Esters	H	H F							H G	H						13																									
14	Ethers	H	H F															14																								
15	Fluorides, inorganic	GT	GT	GT															15																							
16	Hydrocarbons, aromatic		H F																	16																						
17	Halogenated organics	H GT	H F GT					H GT	H G	H GF	H										17																					
18	Isocyanates	H G	H F GT	H G	H P			H P	H G	H P G	H G	U										18																				
19	Ketonas	H	H F						H G	H	H												19																			
20	Mercaptans & other organic sulfides	GT GF	H F GT						H G		H	H	H			H	H	H					20																			
21	Metal, alka & alkaline earth, elemental	GF H F	GF H F	GF H F	GF H F	GF H	GF H	GF H	GF H	GF H	GF H	GF H	GF GT H	GF H			H E	GF H	GF H	GF H	GF H			21																		
104	Oxidizing agents, strong	H GT	H GT	H F	H F	H GT	F GT H	H E	H F GT	H E GT	H E GT	H F	H F	H F	H GT	H F GT	H F	H F GT	H F GE					104																		
105	Reacting agents, strong	H GF	H F GT	H GF	H GF F	GF H F	GF H	H GF	H G				H GT	H F	H T	GF H	GF H	GF H						H F E	105																	
106	Water & mixtures containing water	H	H													H G							GF H		GF GT	106																
106	Water reactive substances	Extremely Reactive! Do not mix with any chemical or waste material																				107																				
		1	2	3	4	5	6	7	8	9	10	11	12	13	14	15	16	17	18	19	20	21	22	23	24	25	26	27	28	29	30	31	32	33	34	101	102	103	104	105	106	107

KEY

Reactivity code	Consequences
H	Heat generation
F	Fire
G	Innocuous and nonflamable gas generation
GT	Toxic gas generation
GF	Flammable gas generation
E	Explosion
P	Violent polymerization
S	Solubilization of toxic substances
U	May be hazardous but unknown

Example:

H	Heat generation, fire, and toxic gas generation
F	
GT	

ELECTRICAL AND COMPUTER ENGINEERING

ELECTROMAGNETIC DYNAMIC FIELDS

The integral and point form of Maxwell's equations are

$$\oint \mathbf{E} \cdot d\mathbf{l} = - \iint_S (\partial \mathbf{B} / \partial t) \cdot d\mathbf{S}$$

$$\oint \mathbf{H} \cdot d\mathbf{l} = I_{enc} + \iint_S (\partial \mathbf{D} / \partial t) \cdot d\mathbf{S}$$

$$\oiint_{S_V} \mathbf{D} \cdot d\mathbf{S} = \iiint_V \rho \, dv$$

$$\oiint_{S_V} \mathbf{B} \cdot d\mathbf{S} = 0$$

$$\nabla \times \mathbf{E} = - \partial \mathbf{B} / \partial t$$

$$\nabla \times \mathbf{H} = \mathbf{J} + \partial \mathbf{D} / \partial t$$

$$\nabla \cdot \mathbf{D} = \rho$$

$$\nabla \cdot \mathbf{B} = 0$$

The sinusoidal wave equation in \mathbf{E} for an isotropic homogeneous medium is given by

$$\nabla^2 \mathbf{E} = - \omega^2 \mu \epsilon \mathbf{E}$$

The EM energy flow of a volume V enclosed by the surface S_V can be expressed in terms of the Poynting's Theorem

$$- \oiint_{S_V} (\mathbf{E} \times \mathbf{H}) \cdot d\mathbf{S} = \iiint_V \mathbf{J} \cdot \mathbf{E} \, dv + \partial \partial t \{ \iiint_V (\epsilon E^2 / 2 + \mu H^2 / 2) \, dv \}$$

where the left-side term represents the energy flow per unit time or power flow into the volume V , whereas the $\mathbf{J} \cdot \mathbf{E}$ represents the loss in V and the last term represents the rate of change of the energy stored in the \mathbf{E} and \mathbf{H} fields.

LOSSLESS TRANSMISSION LINES

The wavelength, λ , of a sinusoidal signal is defined as the distance the signal will travel in one period.

$$\lambda = \frac{U}{f}$$

where U is the velocity of propagation and f is the frequency of the sinusoid.

The characteristic impedance, Z_0 , of a transmission line is the input impedance of an infinite length of the line and is given by

$$Z_0 = \sqrt{L/C}$$

where L and C are the per unit length inductance and capacitance of the line.

The reflection coefficient at the load is defined as

$$\Gamma = \frac{Z_L - Z_0}{Z_L + Z_0}$$

and the standing wave ratio SWR is

$$SWR = \frac{1 + |\Gamma|}{1 - |\Gamma|}$$

$$\beta = \text{Propagation constant} = \frac{2\pi}{\lambda}$$

For sinusoidal voltages and currents:

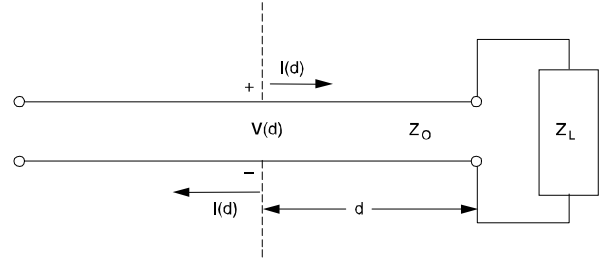

Voltage across the transmission line:

$$V(d) = V^+ e^{j\beta d} + V^- e^{-j\beta d}$$

Current along the transmission line:

$$I(d) = I^+ e^{j\beta d} + I^- e^{-j\beta d}$$

where $I^+ = V^+ / Z_0$ and $I^- = -V^- / Z_0$

Input impedance at d

$$Z_{in}(d) = Z_0 \frac{Z_L + jZ_0 \tan(\beta d)}{Z_0 + jZ_L \tan(\beta d)}$$

AC MACHINES

The synchronous speed n_s for AC motors is given by

$$n_s = 120f/p, \text{ where}$$

f = the line voltage frequency in Hz and

p = the number of poles.

The slip for an induction motor is

$$\text{slip} = (n_s - n) / n_s, \text{ where}$$

n = the rotational speed (rpm).

DC MACHINES

The armature circuit of a DC machine is approximated by a series connection of the armature resistance R_a , the armature inductance L_a , and a dependent voltage source of value

$$V_a = K_a n \phi \text{ volts, where}$$

K_a = constant depending on the design,

n = is armature speed in rpm, and

ϕ = the magnetic flux generated by the field.

The field circuit is approximated by the field resistance R_f in series with the field inductance L_f . Neglecting saturation, the magnetic flux generated by the field current I_f is

$$\phi = K_f I_f \text{ webers}$$

The mechanical power generated by the armature is

$$P_m = V_a I_a \text{ watts}$$

where I_a is the armature current. The mechanical torque produced is

$$T_m = (60/2\pi) K_a \phi I_a \text{ newton-meters.}$$

BALANCED THREE-PHASE SYSTEMS

The three-phase line-phase relations are

$$I_L = \sqrt{3}I_p \quad (\text{for delta})$$

$$V_L = \sqrt{3}V_p \quad (\text{for wye})$$

where subscripts L/p denote line/phase respectively. Three-phase complex power is defined by

$$S = P + jQ$$

$$S = \sqrt{3}V_L I_L (\cos\theta_p + j\sin\theta_p), \text{ where}$$

S = total complex volt-amperes,

P = real power (watts),

Q = reactive power (VARs), and

θ_p = power factor angle of each phase.

CONVOLUTION

Continuous-time convolution:

$$V(t) = x(t) * y(t) = \int_{-\infty}^{\infty} x(\tau)y(t-\tau)d\tau$$

Discrete-time convolution:

$$V[n] = x[n] * y[n] = \sum_{k=-\infty}^{\infty} x[k]y[n-k]$$

DIGITAL SIGNAL PROCESSING

A discrete-time, linear, time-invariant (DTLTI) system with a single input $x[n]$ and a single output $y[n]$ can be described by a linear difference equation with constant coefficients of the form

$$y[n] + \sum_{i=1}^k b_i y[n-i] = \sum_{i=0}^l a_i x[n-i]$$

If all initial conditions are zero, taking a z-transform yields a transfer function

$$H(z) = \frac{Y(z)}{X(z)} = \frac{\sum_{i=0}^l a_i z^{k-i}}{z^k + \sum_{i=1}^k b_i z^{k-i}}$$

Two common discrete inputs are the unit-step function $u[n]$ and the unit impulse function $\delta[n]$, where

$$u[n] = \begin{cases} 0 & n < 0 \\ 1 & n \geq 0 \end{cases} \quad \text{and} \quad \delta[n] = \begin{cases} 1 & n = 0 \\ 0 & n \neq 0 \end{cases}$$

The impulse response $h[n]$ is the response of a discrete-time system to $x[n] = \delta[n]$.

A finite impulse response (FIR) filter is one in which the impulse response $h[n]$ is limited to a finite number of points:

$$h[n] = \sum_{i=0}^k a_i \delta[n-i]$$

The corresponding transfer function is given by

$$H(z) = \sum_{i=0}^k a_i z^{-i}$$

where k is the order of the filter.

An infinite impulse response (IIR) filter is one in which the impulse response $h[n]$ has an infinite number of points:

$$h[n] = \sum_{i=0}^{\infty} a_i \delta[n-i]$$

COMMUNICATION THEORY CONCEPTS

Spectral characterization of communication signals can be represented by mathematical transform theory. An amplitude modulated (AM) signal form is

$$v(t) = A_c [1 + m(t)] \cos \omega_c t, \text{ where}$$

A_c = carrier signal amplitude.

If the modulation baseband signal $m(t)$ is of sinusoidal form with frequency ω_m or

$$m(t) = m \cos \omega_m t$$

then m is the index of modulation with $m > 1$ implying overmodulation. An angle modulated signal is given by

$$v(t) = A \cos [\omega_c t + \phi(t)]$$

where the angle modulation $\phi(t)$ is a function of the baseband signal. The angle modulation form

$$\phi(t) = k_p m(t)$$

is termed phase modulation since angle variations are proportional to the baseband signal $m_i(t)$. Alternately

$$\phi(t) = k_f \int_{-\infty}^t m(\tau) d\tau$$

is termed frequency modulation. Therefore, the instantaneous phase associated with $v(t)$ is defined by

$$\phi_i(t) = \omega_c t + k_f \int_{-\infty}^t m(\tau) d\tau$$

from which the instantaneous frequency

$$\omega_i = \frac{d\phi_i(t)}{dt} = \omega_c + k_f m(t) = \omega_c + \Delta\omega(t)$$

where the frequency deviation is proportional to the baseband signal or

$$\Delta\omega(t) = k_f m(t)$$

These fundamental concepts form the basis of analog communication theory. Alternately, sampling theory, conversion, and PCM (Pulse Code Modulation) are fundamental concepts of digital communication.

FOURIER SERIES

If $f(t)$ satisfies certain continuity conditions and the relationship for periodicity given by

$$f(t) = f(t + T) \quad \text{for all } t$$

then $f(t)$ can be represented by the trigonometric and complex Fourier series given by

$$f(t) = A_0 + \sum_{n=1}^{\infty} A_n \cos n\omega_0 t + \sum_{n=1}^{\infty} B_n \sin n\omega_0 t$$

and

$$f(t) = \sum_{n=-\infty}^{\infty} C_n e^{jn\omega_0 t}, \text{ where}$$

SOLID-STATE ELECTRONICS AND DEVICES

Conductivity of a semiconductor material:

$$\sigma = q(n\mu_n + p\mu_p), \text{ where}$$

 $\mu_n \equiv$ electron mobility, $\mu_p \equiv$ hole mobility, $n \equiv$ electron concentration, $p \equiv$ hole concentration, and $q \equiv$ charge on an electron.

Doped material:

 p -type material; $p_p \approx N_a$ n -type material; $n_n \approx N_d$

Carrier concentrations at equilibrium

$$(p)(n) = n_i^2, \text{ where}$$

 $n_i \equiv$ intrinsic concentration.Built-in potential (contact potential) of a p - n junction:

$$V_0 = \frac{kT}{q} \ln \frac{N_a N_d}{n_i^2}, \text{ where}$$

Thermal voltage

$$V_T = \frac{kT}{q}$$

 $N_a =$ acceptor concentration, $N_d =$ donor concentration, $T =$ temperature (K), and $k =$ Boltzmann's Constant = 1.38×10^{-23} J/KCapacitance of abrupt p - n junction diode

$$C(V) = C_o / \sqrt{1 - V/V_{bi}}, \text{ where}$$

 $C_o =$ junction capacitance at $V = 0$, $V =$ potential of anode with respect to cathode, and $V_{bi} =$ junction contact potential.

Resistance of a diffused layer is

$$R = R_{\square} (L/W), \text{ where}$$

 $R_{\square} =$ sheet resistance = ρ/d in ohms per square $\rho =$ resistivity, $d =$ thickness, $L =$ length of diffusion, and $W =$ width of diffusion.**TABULATED CHARACTERISTICS FOR:****Diodes****Bipolar Junction Transistor (BJT)****N-Channel JFET and MOSFET****Enhancement MOSFETs**

follow on pages 137–140.

$$\omega_o = 2\pi/T$$

$$A_o = (1/T) \int_t^{t+T} f(\tau) d\tau$$

$$A_n = (2/T) \int_t^{t+T} f(\tau) \cos n\omega_o \tau d\tau$$

$$B_n = (2/T) \int_t^{t+T} f(\tau) \sin n\omega_o \tau d\tau$$

$$C_n = (1/T) \int_t^{t+T} f(\tau) e^{-jn\omega_o \tau} d\tau$$

Three useful and common Fourier series forms are defined in terms of the following graphs (with $\omega_o = 2\pi/T$).

Given:

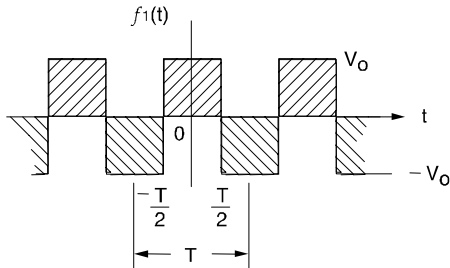

then

$$f_1(t) = \sum_{\substack{n=1 \\ (n \text{ odd})}}^{\infty} (-1)^{(n-1)/2} (4V_o/n\pi) \cos(n\omega_o t)$$

Given:

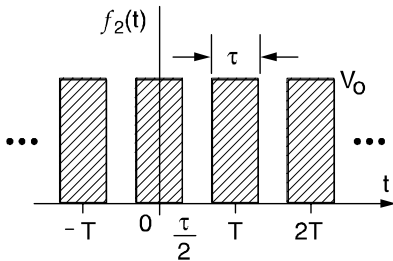

then

$$f_2(t) = \frac{V_o \tau}{T} + \frac{2V_o \tau}{T} \sum_{n=1}^{\infty} \frac{\sin(n\pi\tau/T)}{(n\pi\tau/T)} \cos(n\omega_o t)$$

$$f_2(t) = \frac{V_o \tau}{T} \sum_{n=-\infty}^{\infty} \frac{\sin(n\pi\tau/T)}{(n\pi\tau/T)} e^{jn\omega_o t}$$

Given:

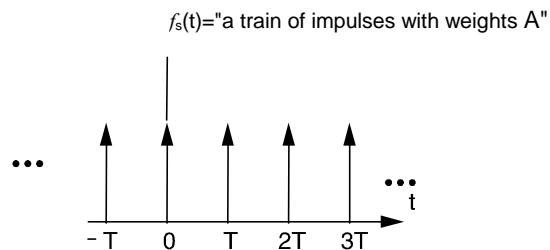

then

$$f_3(t) = \sum_{n=-\infty}^{\infty} A \delta(t - nT)$$

$$f_3(t) = (A/T) + (2A/T) \sum_{n=1}^{\infty} \cos(n\omega_o t)$$

$$f_3(t) = (A/T) \sum_{n=-\infty}^{\infty} e^{jn\omega_o t}$$

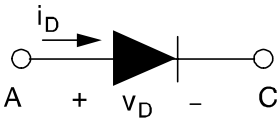
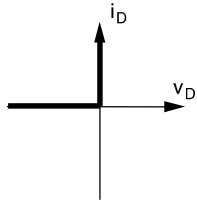
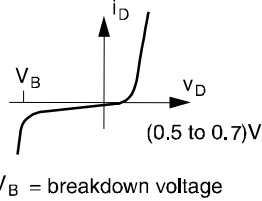
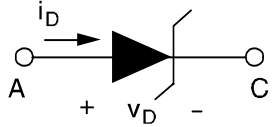
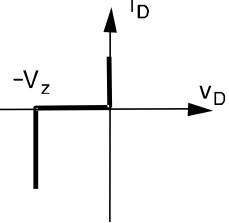
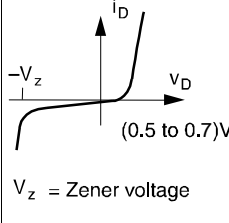
DIODES			
Device and Schematic Symbol	Ideal $I - V$ Relationship	Piecewise-Linear Approximation of The $I - V$ Relationship	Mathematical $I - V$ Relationship
(Junction Diode) 		 <p>$V_B =$ breakdown voltage</p>	Shockley Equation $i_D \approx I_s [e^{(v_D/\eta V_T)} - 1]$ where $I_s =$ saturation current $\eta =$ emission coefficient, typically 1 for Si $V_T =$ thermal voltage $= \frac{kT}{q}$
(Zener Diode) 		 <p>$V_z =$ Zener voltage</p>	Same as above.

NPN Bipolar Junction Transistor (BJT)

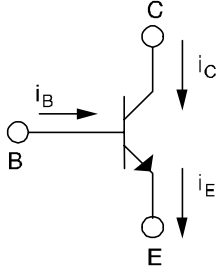
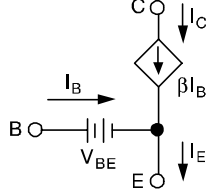
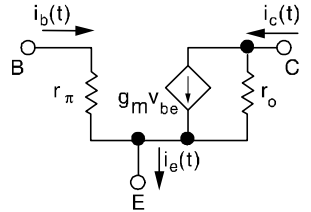
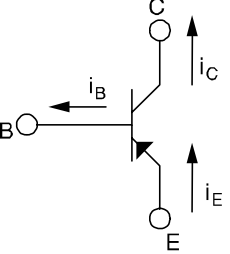
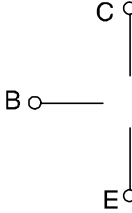
Schematic Symbol	Mathematical Relationships	Large-Signal (DC) Equivalent Circuit	Low-Frequency Small-Signal (AC) Equivalent Circuit
 <p style="text-align: center;">NPN - Transistor</p>	$i_E = i_B + i_C$ $i_C = \beta i_B$ $i_C = \alpha i_E$ $\alpha = \beta / (\beta + 1)$ $i_C \approx I_s e^{(v_{BE}/V_T)}$ $I_s =$ emitter saturation current $V_T =$ thermal voltage Note: These relationships are valid in the active mode of operation.	<p>Active Region: base emitter junction forward biased; base collector junction reverse biased</p> 	<p>Low Frequency: $g_m \approx I_{CQ}/V_T$ $r_\pi \approx \beta/g_m$</p> $r_o = \left[\frac{\partial v_{CE}}{\partial i_c} \right]_{Q_{point}} \approx \frac{V_A}{I_{CQ}}$ <p>where $I_{CQ} =$ dc collector current at the Q_{point} $V_A =$ Early voltage</p> 
 <p style="text-align: center;">PNP - Transistor</p>	Same as for NPN with current directions and voltage polarities reversed.	<p>Cutoff Region: both junctions reversed biased</p> 	Same as for NPN.
		Same as NPN with current directions and voltage polarities reversed	

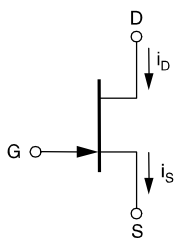
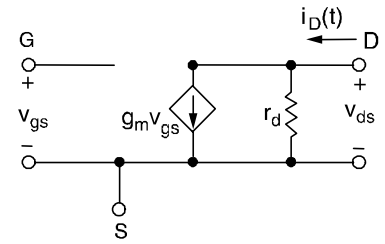
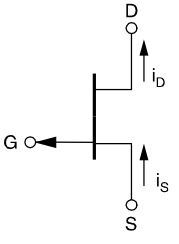
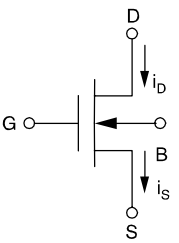
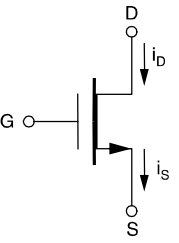
N-Channel Junction Field Effect Transistors (JFETs) and Depletion MOSFETs (Low and Medium Frequency)		
Schematic Symbol	Mathematical Relationships	Small-Signal (AC) Equivalent Circuit
<p>N-CHANNEL JFET</p> 	<p><u>Cutoff Region:</u> $v_{GS} < V_p$ $i_D = 0$</p> <p><u>Triode Region:</u> $v_{GS} > V_p$ and $v_{GD} > V_p$ $i_D = (I_{DSS}/V_p^2)[2v_{DS}(v_{GS} - V_p) - v_{DS}^2]$</p> <p><u>Saturation Region:</u> $v_{GS} > V_p$ and $v_{GD} < V_p$ $i_D = I_{DSS}(1 - v_{GS}/V_p)^2$ where I_{DSS} = drain current with $v_{GS} = 0$ (in the saturation region) $= KV_p^2$, K = conductivity factor, and V_p = pinch-off voltage.</p>	<p>$g_m = \frac{2\sqrt{I_{DSS}I_D}}{ V_p }$ in saturation region</p>  <p>where</p> $r_d = \left. \frac{\partial v_{ds}}{\partial i_d} \right _{Q_{point}}$
<p>P-CHANNEL JFET</p> 		
<p>N-CHANNEL DEPLETION MOSFET (NMOS)</p> 		
<p>SIMPLIFIED SYMBOL</p> 		

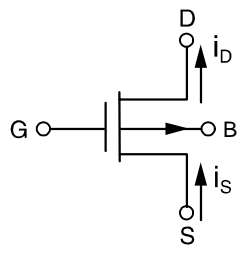
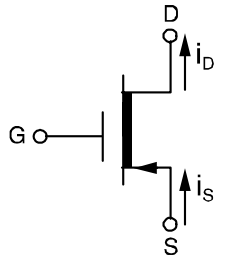
<p>P-Channel Depletion MOSFET (PMOS)</p>  <p>SIMPLIFIED SYMBOL</p> 	Same as for N-channel with current directions and voltage polarities reversed.	Same as for N-channel.
---	--	------------------------

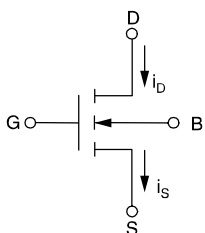
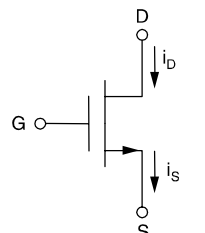
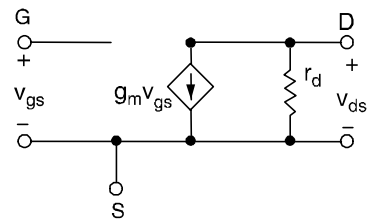
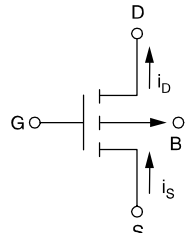
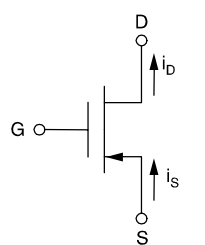
Enhancement MOSFET (Low and Medium Frequency)		
Schematic Symbol	Mathematical Relationships	Small-Signal (AC) Equivalent Circuit
<p>N-CHANNEL ENHANCEMENT MOSFET (NMOS)</p>  <p>SIMPLIFIED SYMBOL</p> 	<p><u>Cutoff Region:</u> $v_{GS} < V_t$ $i_D = 0$</p> <p><u>Triode Region:</u> $v_{GS} > V_t$ and $v_{GD} > V_t$ $i_D = K [2v_{DS}(v_{GS} - V_t) - v_{DS}^2]$</p> <p><u>Saturation Region:</u> $v_{GS} > V_t$ and $v_{GD} < V_t$ $i_D = K (v_{GS} - V_t)^2$ where $K =$ conductivity factor $V_t =$ threshold voltage</p>	<p>$g_m = 2K(v_{GS} - V_t)$ in saturation region</p>  <p>where</p> $r_d = \left. \frac{\partial v_{ds}}{\partial i_d} \right _{Q_{point}}$
<p>P-CHANNEL ENHANCEMENT MOSFET (PMOS)</p>  <p>SIMPLIFIED SYMBOL</p> 	<p>Same as for N-channel with current directions and voltage polarities reversed.</p>	<p>Same as for N-channel.</p>

NUMBER SYSTEMS AND CODES

An unsigned number of base- r has a decimal equivalent D defined by

$$D = \sum_{k=0}^n a_k r^k + \sum_{i=1}^m a_i r^{-i}, \text{ where}$$

$a_k =$ the $(k+1)$ digit to the left of the radix point and

$a_i =$ the i th digit to the right of the radix point.

Binary Number System

In digital computers, the base-2, or binary, number system is normally used. Thus the decimal equivalent, D , of a binary number is given by

$$D = \alpha_k 2^k + \alpha_{k-1} 2^{k-1} + \dots + \alpha_0 + \alpha_{-1} 2^{-1} + \dots$$

Since this number system is so widely used in the design of digital systems, we use a short-hand notation for some powers of two:

$2^{10} = 1,024$ is abbreviated "K" or "kilo"

$2^{20} = 1,048,576$ is abbreviated "M" or "mega"

Signed numbers of base- r are often represented by the radix complement operation. If M is an N -digit value of base- r , the radix complement $R(M)$ is defined by

$$R(M) = r^N - M$$

The 2's complement of an N -bit binary integer can be written

$$\text{2's Complement } (M) = 2^N - M$$

This operation is equivalent to taking the 1's complement (inverting each bit of M) and adding one.

The following table contains equivalent codes for a four-bit binary value.

Binary Base-2	Decimal Base-10	Hexa-decimal Base-16	Octal Base-8	BCD Code	Gray Code
0000	0	0	0	0	0000
0001	1	1	1	1	0001
0010	2	2	2	2	0011
0011	3	3	3	3	0010
0100	4	4	4	4	0110
0101	5	5	5	5	0111
0110	6	6	6	6	0101
0111	7	7	7	7	0100
1000	8	8	10	8	1100
1001	9	9	11	9	1101
1010	10	A	12	---	1111
1011	11	B	13	---	1110
1100	12	C	14	---	1010
1101	13	D	15	---	1011
1110	14	E	16	---	1001
1111	15	F	17	---	1000

LOGIC OPERATIONS AND BOOLEAN ALGEBRA

Three basic logic operations are the "AND (\cdot)," "OR ($+$)," and "Exclusive-OR (\oplus)" functions. The definition of each function, its logic symbol, and its Boolean expression are given in the following table.

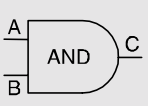
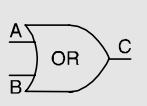
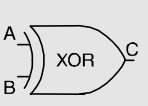
Function			
Inputs			
$A B$	$C = A \cdot B$	$C = A + B$	$C = A \oplus B$
0 0	0	0	0
0 1	0	1	1
1 0	0	1	1
1 1	1	1	0

As commonly used, A AND B is often written AB or $A \cdot B$.

The not operator inverts the sense of a binary value

($0 \rightarrow 1, 1 \rightarrow 0$)

NOT OPERATOR

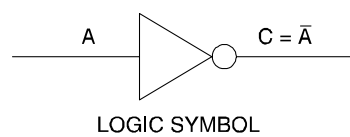

Input	Output
A	$C = \bar{A}$
0	1
1	0

DeMorgan's Theorem

first theorem: $\overline{A + B} = \bar{A} \cdot \bar{B}$

second theorem: $\overline{A \cdot B} = \bar{A} + \bar{B}$

These theorems define the NAND gate and the NOR gate. Logic symbols for these gates are shown below.

NAND Gates: $\overline{A \cdot B} = \bar{A} + \bar{B}$

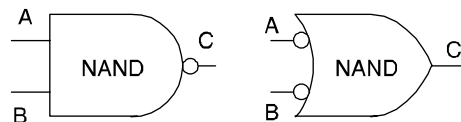

NOR Gates: $\overline{A + B} = \bar{A} \cdot \bar{B}$

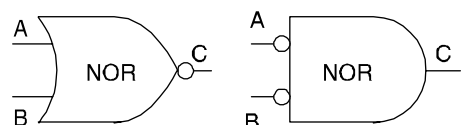

FLIP-FLOPS

A flip-flop is a device whose output can be placed in one of two states, 0 or 1. The flip-flop output is synchronized with a clock (CLK) signal. Q_n represents the value of the flip-flop output before CLK is applied, and Q_{n+1} represents the output after CLK has been applied. Three basic flip-flops are described below.

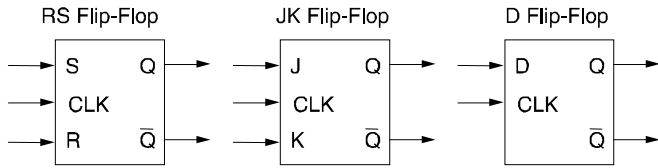

SR	Q_{n+1}	JK	Q_{n+1}	D	Q_{n+1}
00	Q_n no change	00	Q_n no change	0	0
01	0	01	0	1	1
10	1	10	1		
11	x invalid	11	\bar{Q}_n toggle		

Composite Flip-Flop State Transition						
Q_n	Q_{n+1}	S	R	J	K	D
0	0	0	x	0	x	0
0	1	1	0	1	x	1
1	0	0	1	x	1	0
1	1	x	0	x	0	1

Switching Function Terminology

Minterm, m_i – A product term which contains an occurrence of every variable in the function.

Maxterm, M_i – A sum term which contains an occurrence of every variable in the function.

Implicant – A Boolean algebra term, either in sum or product form, which contains one or more minterms or maxterms of a function.

Prime Implicant – An implicant which is not entirely contained in any other implicant.

Essential Prime Implicant – A prime implicant which contains a minterm or maxterm which is not contained in any other prime implicant.

A function can be described as a sum of minterms using the notation

$$F(ABCD) = \sum m(h, i, j, \dots)$$

$$= m_h + m_i + m_j + \dots$$

A function can be described as a product of maxterms using the notation

$$G(ABCD) = \prod M(h, i, j, \dots)$$

$$= M_h \cdot M_i \cdot M_j \dots$$

A function represented as a sum of minterms only is said to be in *canonical sum of products* (SOP) form. A function represented as a product of maxterms only is said to be in *canonical product of sums* (POS) form. A function in canonical SOP form is often represented as a *minterm list*, while a function in canonical POS form is often represented as a *maxterm list*.

A *Karnaugh Map* (K-Map) is a graphical technique used to represent a truth table. Each square in the K-Map represents one minterm, and the squares of the K-Map are arranged so that the adjacent squares differ by a change in exactly one variable. A four-variable K-Map with its corresponding minterms is shown below. K-Maps are used to simplify switching functions by visually identifying all essential prime implicants.

Four-variable Karnaugh Map

AB \ CD	00	01	11	10
00	m_0	m_1	m_3	m_2
01	m_4	m_5	m_7	m_6
11	m_{12}	m_{13}	m_{15}	m_{14}
10	m_8	m_9	m_{11}	m_{10}

INDUSTRIAL ENGINEERING

LINEAR PROGRAMMING

The general linear programming (LP) problem is:

$$\text{Maximize } Z = c_1x_1 + c_2x_2 + \dots + c_nx_n$$

Subject to:

$$a_{11}x_1 + a_{12}x_2 + \dots + a_{1n}x_n \leq b_1$$

$$a_{21}x_1 + a_{22}x_2 + \dots + a_{2n}x_n \leq b_2$$

...

...

$$a_{m1}x_1 + a_{m2}x_2 + \dots + a_{mn}x_n \leq b_m,$$

where $x_1, \dots, x_n \geq 0$

An LP problem is frequently reformulated by inserting slack and surplus variables. Although these variables usually have zero costs (depending on the application), they can have non-zero cost coefficients in the objective function. A slack variable is used with a "less than" inequality and transforms it into an equality. For example, the inequality $5x_1 + 3x_2 + 2x_3 \leq 5$ could be changed to $5x_1 + 3x_2 + 2x_3 + s_1 = 5$ if s_1 were chosen as a slack variable. The inequality $3x_1 + x_2 - 4x_3 \geq 10$ might be transformed into $3x_1 + x_2 - 4x_3 - s_2 = 10$ by the addition of the surplus variable s_2 . Computer printouts of the results of processing and LP usually include values for all slack and surplus variables, the dual prices, and the reduced cost for each variable.

DUAL LINEAR PROGRAM

Associated with the general linear programming problem is another problem called the dual linear programming problem. If we take the previous problem and call it the primal problem, then in matrix form the primal and dual problems are respectively:

Primal

Dual

Maximize $Z = cx$

Minimize $W = yb$

Subject to: $Ax \leq b$

Subject to: $yA \geq c$

$x \geq 0$

$y \geq 0$

If A is a matrix of size $[m \times n]$, then y is an $[1 \times m]$ vector, c is an $[1 \times n]$ vector, and b is an $[m \times 1]$ vector.

x is an $[n \times 1]$ vector.

STATISTICAL QUALITY CONTROL

Average and Range Charts

n	A_2	D_3	D_4
2	1.880	0	3.268
3	1.023	0	2.574
4	0.729	0	2.282
5	0.577	0	2.114
6	0.483	0	2.004
7	0.419	0.076	1.924
8	0.373	0.136	1.864
9	0.337	0.184	1.816
10	0.308	0.223	1.777

X = an individual observation

n = the sample size of a group

k = the number of groups

R = (range) the difference between the largest and smallest observations in a sample of size n .

$$\bar{X} = \frac{X_1 + X_2 + \dots + X_n}{n}$$

$$\bar{\bar{X}} = \frac{\bar{X}_1 + \bar{X}_2 + \dots + \bar{X}_k}{k}$$

$$\bar{R} = \frac{R_1 + R_2 + \dots + R_k}{k}$$

The R Chart equations are:

$$CL_R = \bar{R}$$

$$UCL_R = D_4 \bar{R}$$

$$LCL_R = D_3 \bar{R}$$

The \bar{X} Chart equations are:

$$CL_X = \bar{\bar{X}}$$

$$UCL_X = \bar{\bar{X}} + A_2 \bar{R}$$

$$LCL_X = \bar{\bar{X}} - A_2 \bar{R}$$

Standard Deviation Charts

n	A_3	B_3	B_4
2	2.659	0	3.267
3	1.954	0	2.568
4	1.628	0	2.266
5	1.427	0	2.089
6	1.287	0.030	1.970
7	1.182	0.119	1.882
8	1.099	0.185	1.815
9	1.032	0.239	1.761
10	0.975	0.284	1.716

$$UCL_X = \bar{\bar{X}} + A_3 \bar{S}$$

$$CL_X = \bar{\bar{X}}$$

$$LCL_X = \bar{\bar{X}} - A_3 \bar{S}$$

$$UCL_S = B_4 \bar{S}$$

$$CL_S = \bar{S}$$

$$LCL_S = B_3 \bar{S}$$

Approximations

The following table and equations may be used to generate initial approximations of the items indicated.

n	c_4	d_2	d_3
2	0.7979	1.128	0.853
3	0.8862	1.693	0.888
4	0.9213	2.059	0.880
5	0.9400	2.326	0.864
6	0.9515	2.534	0.848
7	0.9594	2.704	0.833
8	0.9650	2.847	0.820
9	0.9693	2.970	0.808
10	0.9727	3.078	0.797

$$\hat{\sigma} = \bar{R}/d_2$$

$$\hat{\sigma} = \bar{S}/c_4$$

$$\sigma_R = d_3 \hat{\sigma}$$

$$\sigma_s = \hat{\sigma} \sqrt{1 - c_4^2}, \text{ where}$$

$\hat{\sigma}$ = an estimate of σ ,

σ_R = an estimate of the standard deviation of the ranges of the samples, and

σ_s = an estimate of the standard deviation of the standard deviations.

Tests for Out of Control

1. A single point falls outside the (three sigma) control limits.
2. Two out of three successive points fall on the same side of and more than two sigma units from the center line.
3. Four out of five successive points fall on the same side of and more than one sigma unit from the center line.
4. Eight successive points fall on the same side of the center line.

QUEUEING MODELS

Definitions

P_n = probability of n units in system,

L = expected number of units in the system,

L_q = expected number of units in the queue,

W = expected waiting time in system,

W_q = expected waiting time in queue,

λ = mean arrival rate (constant),

μ = mean service rate (constant),

ρ = server utilization factor, and

s = number of servers.

Kendall notation for describing a queueing system:

$$A / B / s / M$$

A = the arrival process,

B = the service time distribution,

s = the number of servers, and

M = the total number of customers including those in service.

Fundamental Relationships

$$L = \lambda W$$

$$L_q = \lambda W_q$$

$$W = W_q + 1/\mu$$

$$\rho = \lambda / (s\mu)$$

Single Server Models ($s = 1$)

Poisson Input—Exponential Service Time: $M = \infty$

$$P_0 = 1 - \lambda/\mu = 1 - \rho$$

$$P_n = (1 - \rho)\rho^n = P_0\rho^n$$

$$L = \rho/(1 - \rho) = \lambda/(\mu - \lambda)$$

$$L_q = \lambda^2/[\mu(\mu - \lambda)]$$

$$W = 1/[\mu(1 - \rho)] = 1/(\mu - \lambda)$$

$$W_q = W - 1/\mu = \lambda/[\mu(\mu - \lambda)]$$

Finite queue: $M < \infty$

$$P_0 = (1 - \rho)/(1 - \rho^{M+1})$$

$$P_n = [(1 - \rho)/(1 - \rho^{M+1})]\rho^n$$

$$L = \rho/(1 - \rho) - (M + 1)\rho^{M+1}/(1 - \rho^{M+1})$$

$$L_q = L - (1 - P_0)$$

Poisson Input—Arbitrary Service Time

Variance σ^2 is known. For constant service time, $\sigma^2 = 0$.

$$P_0 = 1 - \rho$$

$$L_q = (\lambda^2\sigma^2 + \rho^2)/[2(1 - \rho)]$$

$$L = \rho + L_q$$

$$W_q = L_q/\lambda$$

$$W = W_q + 1/\mu$$

Poisson Input—Erlang Service Times, $\sigma^2 = 1/(k\mu^2)$

$$L_q = [(1 + k)/(2k)][(\lambda^2)/(\mu(\mu - \lambda))]$$

$$= [\lambda^2/(k\mu^2) + \rho^2]/[2(1 - \rho)]$$

$$W_q = [(1 + k)/(2k)]\{\lambda/[\mu(\mu - \lambda)]\}$$

$$W = W_q + 1/\mu$$

Multiple Server Model ($s > 1$)

Poisson Input—Exponential Service Times

$$P_0 = \left\{ \sum_{n=0}^{s-1} \frac{\left(\frac{\lambda}{\mu}\right)^n}{n!} + \frac{\left(\frac{\lambda}{\mu}\right)^s}{s!} \left[\frac{1}{1 - \frac{\lambda}{s\mu}} \right] \right\}^{-1}$$

$$= 1 / \left[\sum_{n=0}^{s-1} \frac{(s\rho)^n}{n!} + \frac{(s\rho)^s}{s!(1 - \rho)} \right]$$

$$L_q = \frac{P_0 \left(\frac{\lambda}{\mu}\right)^s \rho}{s!(1 - \rho)^2}$$

$$= \frac{P_0 s^s \rho^{s+1}}{s!(1 - \rho)^2}$$

$$P_n = P_0 (\lambda/\mu)^n / n! \quad 0 \leq n \leq s$$

$$P_n = P_0 (\lambda/\mu)^n / (s! s^{n-s}) \quad n \geq s$$

$$W_q = L_q/\lambda$$

$$W = W_q + 1/\mu$$

$$L = L_q + \lambda/\mu$$

Calculations for P_0 and L_q can be time consuming; however, the following table gives formulae for 1, 2, and 3 servers.

s	P_0	L_q
1	$1 - \rho$	$\rho^2/(1 - \rho)$
2	$(1 - \rho)/(1 + \rho)$	$2\rho^3/(1 - \rho^2)$
3	$\frac{2(1 - \rho)}{2 + 4\rho + 3\rho^2}$	$\frac{9\rho^4}{2 + 2\rho - \rho^2 - 3\rho^3}$

MOVING AVERAGE

$$\hat{d}_t = \frac{\sum_{i=1}^n d_{t-i}}{n}, \text{ where}$$

- \hat{d}_t = forecasted demand for period t ,
- d_{t-i} = actual demand for i th period preceding t , and
- n = number of time periods to include in the moving average.

EXPONENTIALLY WEIGHTED MOVING AVERAGE

$$\hat{d}_t = \alpha d_{t-1} + (1 - \alpha) \hat{d}_{t-1}, \text{ where}$$

- \hat{d}_t = forecasted demand for t , and
- α = smoothing constant

LINEAR REGRESSION AND DESIGN OF EXPERIMENTS

Least Squares

$$y = \hat{a} + \hat{b}x, \text{ where}$$

$$y\text{-intercept: } \hat{a} = \bar{y} - \hat{b}\bar{x},$$

$$\text{and slope: } \hat{b} = SS_{xy}/SS_{xx},$$

$$S_{xy} = \sum_{i=1}^n x_i y_i - (1/n) \left(\sum_{i=1}^n x_i \right) \left(\sum_{i=1}^n y_i \right),$$

$$S_{xx} = \sum_{i=1}^n x_i^2 - (1/n) \left(\sum_{i=1}^n x_i \right)^2,$$

n = sample size,

$$\bar{y} = (1/n) \left(\sum_{i=1}^n y_i \right), \text{ and}$$

$$\bar{x} = (1/n) \left(\sum_{i=1}^n x_i \right).$$

Standard Error of Estimate

$$S_e^2 = \frac{S_{xx}S_{yy} - S_{xy}^2}{S_{xx}(n - 2)} = MSE, \text{ where}$$

$$S_{yy} = \sum_{i=1}^n y_i^2 - (1/n) \left(\sum_{i=1}^n y_i \right)^2$$

Confidence Interval for a

$$\hat{a} \pm t_{\alpha/2, n-2} \sqrt{\left(\frac{1}{n} + \frac{\bar{x}^2}{S_{xx}} \right) MSE}$$

Confidence Interval for b

$$\hat{b} \pm t_{\alpha/2, n-2} \sqrt{\frac{MSE}{S_{xx}}}$$

Sample Correlation Coefficient

$$r = \frac{S_{xy}}{\sqrt{S_{xx}S_{yy}}}$$

2ⁿ FACTORIAL EXPERIMENTS

Factors: X_1, X_2, \dots, X_n

Levels of each factor: 1, 2

r = number of observations for each experimental condition (treatment),

E_i = estimate of the effect of factor $X_i, i = 1, 2, \dots, n$,

E_{ij} = estimate of the effect of the interaction between factors X_i and X_j ,

\bar{Y}_{ik} = average response value for all $r2^{n-1}$ observations having X_i set at level $k, k = 1, 2$, and

\bar{Y}_{ij}^{km} = average response value for all $r2^{n-2}$ observations having X_i set at level $k, k = 1, 2$, and X_j set at level $m, m = 1, 2$.

$$E_i = \bar{Y}_{i2} - \bar{Y}_{i1}$$

$$E_{ij} = \frac{(\bar{Y}_{ij}^{22} - \bar{Y}_{ij}^{21}) - (\bar{Y}_{ij}^{12} - \bar{Y}_{ij}^{11})}{2}$$

ONE-WAY ANALYSIS OF VARIANCE (ANOVA)

Given independent random samples of size n from k populations, then:

$$\sum_{i=1}^k \sum_{j=1}^n (x_{ij} - \bar{x})^2 = \sum_{i=1}^k \sum_{j=1}^n (x_{ij} - \bar{x})^2 + n \sum_{i=1}^k (\bar{x}_i - \bar{x})^2 \quad \text{or}$$

$$SS_{\text{Total}} = SS_{\text{Error}} + SS_{\text{Treatments}}$$

Let T be the grand total of all kn observations and T_i be the total of the n observations of the i th sample. See One-Way ANOVA table on page 149.

$$C = T^2/(kn)$$

$$SS_{\text{Total}} = \sum_{i=1}^k \sum_{j=1}^n x_{ij}^2 - C$$

$$SS_{\text{Treatments}} = \sum_{i=1}^k (T_i^2/n) - C$$

$$SS_{\text{Error}} = SS_{\text{Total}} - SS_{\text{Treatments}}$$

ANALYSIS OF VARIANCE FOR 2ⁿ FACTORIAL DESIGNS

Let *E* be the estimate of the effect of a given factor, let *L* be the orthogonal contrast belonging to this effect. It can be proved that

$$E = \frac{L}{2^{n-1}}$$

$$L = \sum_{c=1}^m a_{(c)} \bar{Y}_{(c)}$$

$$SS_L = \frac{rL^2}{2^n}, \text{ where}$$

m = number of experimental conditions (*m* = 2^{*n*} for *n* factors),

*a*_(*c*) = -1 if the factor is set at its low level in experimental condition *c*,

*a*_(*c*) = +1 if the factor is set at its high level in experimental condition *c*,

r = number of replications for each experimental condition

$\bar{Y}_{(c)}$ = average response value for experimental condition *c*, and

SS_L = sum of squares associated with the factor.

The sum of the squares due to the random error can be computed as

$$SS_{\text{error}} = SS_{\text{total}} - \sum_i \sum_j SS_{ij} - \dots - SS_{12\dots n}$$

where *SS_i* is the sum of squares due to factor *X_i*, *SS_{ij}* is the sum of squares due to the interaction of factors *X_i* and *X_j*, and so on. The total sum of squares is equal to

$$SS_{\text{total}} = \sum_{c=1}^m \sum_{k=1}^r Y_{ck}^2 - \frac{T^2}{N}$$

where *Y_{ck}*, is the *kth* observation taken for the *cth* experimental condition, *m* = 2^{*n*}, *T* is the grand total of all observations and *N* = *r*2^{*n*}.

LEARNING CURVES

The time to do the repetition *N* of a task is given by

$$T_N = KN^s, \text{ where}$$

K = constant, and

s = ln (learning rate, as a decimal)/ln 2.

If *N* units are to be produced, the average time per unit is given by

$$T_{\text{avg}} = \frac{K}{N(1+s)} \left[(N+0.5)^{(1+s)} - 0.5^{(1+s)} \right]$$

INVENTORY MODELS

For instantaneous replenishment (with constant demand rate, known holding and ordering costs, and an infinite stockout cost), the economic order quantity is given by

$$EOQ = \sqrt{\frac{2AD}{h}}, \text{ where}$$

A = cost to place one order,

D = number of units used per year, and

h = holding cost per unit per year.

Under the same conditions as above with a finite replenishment rate, the economic manufacturing quantity is given by

$$EMQ = \sqrt{\frac{2AD}{h(1-D/R)}}, \text{ where}$$

R = the replenishment rate.

ERGONOMICS

NIOSH Formula

Recommended Weight Limit (U.S. Customary Units)

$$= 51(10/H)(1 - 0.0075|V - 30|)(0.82 + 1.8/D)(1 - 0.0032A)$$

where

H = horizontal distance of the hand from the midpoint of the line joining the inner ankle bones to a point projected on the floor directly below the load center,

V = vertical distance of the hands from the floor,

D = vertical travel distance of the hands between the origin and destination of the lift, and

A = asymmetric angle, in degrees.

The NIOSH formula as stated here assumes that (1) lifting frequency is no greater than one lift every 5 minutes; (2) the person can get a good grip on the object being lifted.

Biomechanics of the Human Body

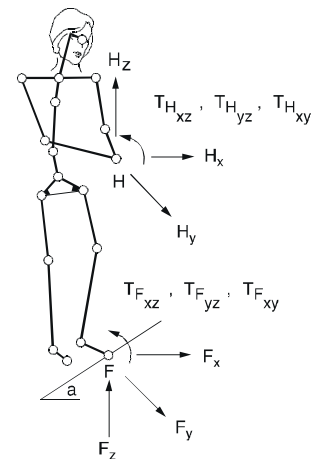

Basic Equations

$$H_x + F_x = 0$$

$$H_y + F_y = 0$$

$$H_z + F_z = 0$$

$$T_{Hxz} + T_{Fxz} = 0$$

$$T_{Hyz} + T_{Fyz} = 0$$

$$T_{Hxy} + T_{Fxy} = 0$$

The coefficient of friction μ and the angle α at which the floor is inclined determine the equations at the foot.

$$F_x = \mu F_z$$

With the slope angle α

$$F_x = \mu F_z \cos \alpha$$

Of course, when motion must be considered, dynamic conditions come into play according to Newton's Second Law. Force transmitted with the hands is counteracted at the foot. Further, the body must also react with internal forces at all points between the hand and the foot.

FACILITY PLANNING

Equipment Requirements

P_{ij} = desired production rate for product i on machine j , measured in pieces per production period,

T_{ij} = production time for product i on machine j , measured in hours per piece,

C_{ij} = number of hours in the production period available for the production of product i on machine j ,

M_j = number of machines of type j required per production period, and

n = number of products.

Therefore, M_j can be expressed as

$$M_j = \sum_{i=1}^n \frac{P_{ij} T_{ij}}{C_{ij}}$$

People Requirements

$$A_j = \sum_{i=1}^n \frac{P_{ij} T_{ij}}{C_{ij}}, \text{ where}$$

A_j = number of crews required for assembly operation j ,

P_{ij} = desired production rate for product i and assembly operation j (pieces per day),

T_{ij} = standard time to perform operation j on product i (minutes per piece),

C_{ij} = number of minutes available per day for assembly operation j on product i , and

n = number of products.

STANDARD TIME DETERMINATION

$$ST = NT \times AF$$

where

NT = normal time, and

AF = allowance factor.

Case 1: Allowances are based on the *job time*.

$$AF_{\text{job}} = 1 + A_{\text{job}}$$

A_{job} = allowance fraction (percentage) based on *job time*.

Case 2: Allowances are based on *workday*.

$$AF_{\text{time}} = 1/(1 - A_{\text{day}})$$

A_{day} = allowance fraction (percentage) based on *workday*.

Plant Location

The following is one formulation of a discrete plant location problem.

Minimize

$$z = \sum_{i=1}^m \sum_{j=1}^n c_{ij} y_{ij} + \sum_{j=1}^n f_j x_j$$

subject to

$$\sum_{i=1}^m y_{ij} \leq m x_j, \quad j = 1, \dots, n$$

$$\sum_{j=1}^n y_{ij} = 1, \quad j = 1, \dots, m$$

$$y_{ij} \geq 0, \text{ for all } i, j$$

$$x_j = (0, 1), \text{ for all } j, \text{ where}$$

m = number of customers,

n = number of possible plant sites,

y_{ij} = fraction or portion of the demand of customer i which is satisfied by a plant located at site j ; $i = 1, \dots, m$; $j = 1, \dots, n$,

x_j = 1, if a plant is located at site j ,

x_j = 0, otherwise,

c_{ij} = cost of supplying the entire demand of customer i from a plant located at site j , and

f_j = fixed cost resulting from locating a plant at site j .

Material Handling

Distances between two points (x_1, y_1) and (x_2, y_2) under different metrics:

Euclidean:

$$D = \sqrt{(x_1 - x_2)^2 + (y_1 - y_2)^2}$$

Rectilinear (or Manhattan):

$$D = |x_1 - x_2| + |y_1 - y_2|$$

Chebyshev (simultaneous x and y movement):

$$D = \max(|x_1 - x_2|, |y_1 - y_2|)$$

Line Balancing

$$N_{\min} = \left(OR \times \sum_i t_i / OT \right)$$

= Theoretical minimum number of stations

$$\text{Idle Time/Station} = CT - ST$$

$$\text{Idle Time/Cycle} = \Sigma (CT - ST)$$

$$\text{Percent Idle Time} = \frac{\text{Idle Time/Cycle}}{N_{\text{actual}} \times CT} \times 100, \text{ where}$$

CT = cycle time (time between units),

OT = operating time/period,

OR = output rate/period,

ST = station time (time to complete task at each station),

t_i = individual task times, and

N = number of stations.

Job Sequencing

Two Work Centers—Johnson's Rule

1. Select the job with the shortest time, from the list of jobs, and its time at each work center.
2. If the shortest job time is the time at the first work center, schedule it first, otherwise schedule it last. Break ties arbitrarily.
3. Eliminate that job from consideration.
4. Repeat 1, 2, and 3 until all jobs have been scheduled.

CRITICAL PATH METHOD (CPM) d_{ij} = duration of activity (i, j) , CP = critical path (longest path), T = duration of project, and

$$T = \sum_{(i,j) \in CP} d_{ij}$$

PERT (a_{ij}, b_{ij}, c_{ij}) = (optimistic, most likely, pessimistic) durations for activity (i, j) , μ_{ij} = mean duration of activity (i, j) , σ_{ij} = standard deviation of the duration of activity (i, j) , μ = project mean duration, and σ = standard deviation of project duration.

$$\mu_{ij} = \frac{a_{ij} + 4b_{ij} + c_{ij}}{6}$$

$$\sigma_{ij} = \frac{c_{ij} - a_{ij}}{6}$$

$$\mu = \sum_{(i,j) \in CP} \mu_{ij}$$

$$\sigma^2 = \sum_{(i,j) \in CP} \sigma_{ij}^2$$

MACHINING FORMULAS**Material Removal Rate Formulas**

1. Drilling:

$$MRR = (\pi/4) D^2 f N, \text{ where}$$

 D = drill diameter, f = feed rate, and N = rpm of the drill.

$$\text{Power} = MRR \times \text{specific power}$$

2. Slab Milling:

Cutting speed is the peripheral speed of the cutter

$$V = \pi D N, \text{ where}$$

 D = cutter diameter, and N = cutter rpm.Feed per tooth f is given by

$$f = v/(Nn), \text{ where}$$

 v = workpiece speed and n = number of teeth on the cutter.

$$t = (l + l_c)/v, \text{ where}$$

 t = cutting time, l = length of workpiece, and l_c = additional length of cutter's travel

$$= \sqrt{Dd} \text{ (approximately).}$$

If $l_c \ll l$

$$MRR = lwd/t, \text{ where}$$

 d = depth of cut, w = min (width of the cut, length of cutter), and cutting time = $t = l/v$.

3. Face Milling:

$$MRR = \text{width} \times \text{depth of cut} \times \text{workpiece speed}$$

$$\text{Cutting time} = \frac{(\text{workpiece length} + \text{tool clearance})}{\text{workpiece speed}}$$

$$= (l + 2l_c)/V$$

$$\text{Feed (per tooth)} = V/(Nn)$$

 l_c = tool travel necessary to completely clear the workpiece; usually = tool diameter/2.**Taylor Tool Life Formula**

$$VT^n = C, \text{ where}$$

 V = speed in surface feet per minute, T = time before the tool reaches a certain percentage of possible wear, and C, n = constants that depend on the material and on the tool.**Work Sampling Formulas**

$$D = Z_{\alpha/2} \sqrt{\frac{p(1-p)}{n}} \quad \text{and} \quad R = Z_{\alpha/2} \sqrt{\frac{1-p}{pn}}, \text{ where}$$

 p = proportion of observed time in an activity, D = absolute error, R = relative error ($R = D/p$), and n = sample size.

ONE-WAY ANOVA TABLE

Source of Variation	Degrees of Freedom	Sum of Squares	Mean Square	F
Between Treatments	$k - 1$	$SS_{\text{Treatments}}$	$MST = \frac{SS_{\text{Treatments}}}{k - 1}$	$\frac{MST}{MSE}$
Error	$k(n - 1)$	SS_{Error}	$MSE = \frac{SS_{\text{Error}}}{k(n - 1)}$	
Total	$kn - 1$	SS_{Total}		

PROBABILITY AND DENSITY FUNCTIONS: MEANS AND VARIANCES

Variable	Equation	Mean	Variance
Binomial Coefficient	$\binom{n}{x} = \frac{n!}{x!(n-x)!}$		
Binomial	$b(x; n, p) = \binom{n}{x} p^x (1-p)^{n-x}$	np	$np(1-p)$
Hyper Geometric	$h(x; n, r, N) = \frac{\binom{r}{x} \binom{N-r}{n-x}}{\binom{N}{n}}$	$\frac{nr}{N}$	$\frac{r(N-r)n(N-n)}{N^2(N-1)}$
Poisson	$f(x; \lambda) = \frac{\lambda^x e^{-\lambda}}{x!}$	λ	λ
Geometric	$g(x; p) = p(1-p)^{x-1}$	$1/p$	$(1-p)/p^2$
Negative Binomial	$f(y; r, p) = \binom{y+r-1}{r-1} p^r (1-p)^y$	r/p	$r(1-p)/p^2$
Multinomial	$f(x_1, \dots, x_k) = \frac{n!}{x_1! \dots x_k!} p_1^{x_1} \dots p_k^{x_k}$	np_i	$np_i(1-p_i)$
Uniform	$f(x) = 1/(b-a)$	$(a+b)/2$	$(b-a)^2/12$
Gamma	$f(x) = \frac{x^{\alpha-1} e^{-x/\beta}}{\beta^\alpha \Gamma(\alpha)}$; $\alpha > 0, \beta > 0$	$\alpha\beta$	$\alpha\beta^2$
Exponential	$f(x) = \frac{1}{\beta} e^{-x/\beta}$	β	β^2
Weibull	$f(x) = \frac{\alpha}{\beta} x^{\alpha-1} e^{-x^\alpha/\beta}$	$\beta^{1/\alpha} \Gamma[(\alpha+1)/\alpha]$	$\beta^{2/\alpha} \left[\Gamma\left(\frac{\alpha+1}{\alpha}\right) - \Gamma^2\left(\frac{\alpha+1}{\alpha}\right) \right]$

Table A. Tests on means of normal distribution—variance known.

<i>Hypothesis</i>	<i>Test Statistic</i>	<i>Criteria for Rejection</i>
$H_0: \mu = \mu_0$ $H_1: \mu \neq \mu_0$	$Z_0 = (\bar{y} - \mu_0) \left(\frac{\sigma}{n^{1/2}} \right)^{-1}$	$ Z_0 > Z_{\alpha/2}$
$H_0: \mu = \mu_0$ $H_1: \mu < \mu_0$		$Z_0 < -Z_{\alpha}$
$H_0: \mu = \mu_0$ $H_1: \mu > \mu_0$	$Z_0 = [(\bar{y}_1 - \bar{y}_2) - \gamma] \left(\frac{\sigma_1^2}{n_1} + \frac{\sigma_2^2}{n_2} \right)^{-1/2}$	$Z_0 > Z_{\alpha}$
$H_0: \mu_1 - \mu_2 = \gamma$ $H_1: \mu_1 - \mu_2 \neq \gamma$		$Z_0 < -Z_{\alpha}$
$H_0: \mu_1 - \mu_2 = \gamma$ $H_1: \mu_1 - \mu_2 < \gamma$	$Z_0 = [(\bar{y}_1 - \bar{y}_2) - \gamma] \left(\frac{\sigma_1^2}{n_1} + \frac{\sigma_2^2}{n_2} \right)^{-1/2}$	$Z_0 < -Z_{\alpha}$
$H_0: \mu_1 - \mu_2 = \gamma$ $H_1: \mu_1 - \mu_2 > \gamma$		$Z_0 > Z_{\alpha}$

Table B. Tests on means of normal distribution—variance unknown.

<i>Hypothesis</i>	<i>Test Statistic</i>	<i>Criteria for Rejection</i>
$H_0: \mu = \mu_0$ $H_1: \mu \neq \mu_0$	$t_0 = (\bar{y} - \mu_0) \left(\frac{S}{n^{1/2}} \right)^{-1}$	$ t_0 > t_{\alpha/2, n-1}$
$H_0: \mu = \mu_0$ $H_1: \mu < \mu_0$		$t_0 < -t_{\alpha, n-1}$
$H_0: \mu = \mu_0$ $H_1: \mu > \mu_0$	$t_0 = (\bar{y}_1 - \bar{y}_2 - \gamma) \left[S_p \left(\frac{1}{n_1} + \frac{1}{n_2} \right)^{1/2} \right]^{-1}$ $v = n_1 + n_2 - 2$	$t_0 > t_{\alpha, n-1}$
$H_0: \mu_1 - \mu_2 = \gamma$ $H_1: \mu_1 - \mu_2 \neq \gamma$		$ t_0 > t_{\alpha/2, v}$
$H_0: \mu_1 - \mu_2 = \gamma$ $H_1: \mu_1 - \mu_2 < \gamma$	$t_0 = (\bar{y}_1 - \bar{y}_2 - \gamma) \left(\frac{S_1^2}{n_1} + \frac{S_2^2}{n_2} \right)^{-1/2}$ $v = \left(\frac{S_1^2}{n_1} + \frac{S_2^2}{n_2} \right)^2 \left[\frac{(S_1^2 n_1^{-1})^2}{n_1 - 1} + \frac{(S_2^2 n_2^{-1})^2}{n_2 - 1} \right]^{-1}$	$t_0 < -t_{\alpha, v}$
$H_0: \mu_1 - \mu_2 = \gamma$ $H_1: \mu_1 - \mu_2 > \gamma$		$t_0 > t_{\alpha, v}$

In Table B, $S_p^2 = [(n_1 - 1)S_1^2 + (n_2 - 1)S_2^2] / v$

Table C. Tests on variances of normal distribution with unknown mean.

<i>Hypothesis</i>	<i>Test Statistic</i>	<i>Criteria for Rejection</i>
$H_0: \sigma^2 = \sigma_0^2$ $H_1: \sigma^2 \neq \sigma_0^2$		$X_0^2 > X_{\alpha/2, n-1}^2$ or $X_0^2 < X_{1-\alpha/2, n-1}^2$
$H_0: \sigma^2 = \sigma_0^2$ $H_1: \sigma^2 < \sigma_0^2$	$X_0^2 = \frac{(n-1)S^2}{\sigma_0^2}$	$X_0^2 < X_{1-\alpha/2, n-1}^2$
$H_0: \sigma^2 = \sigma_0^2$ $H_1: \sigma^2 > \sigma_0^2$		$X_0^2 > X_{\alpha, n-1}^2$
$H_0: \sigma_1^2 = \sigma_2^2$ $H_1: \sigma_1^2 \neq \sigma_2^2$	$F_0 = \frac{S_1^2}{S_2^2}$	$F_0 > F_{\alpha/2, n_1-1, n_2-1}$ $F_0 < F_{1-\alpha/2, n_1-1, n_2-1}$
$H_0: \sigma_1^2 = \sigma_2^2$ $H_1: \sigma_1^2 < \sigma_2^2$	$F_0 = \frac{S_2^2}{S_1^2}$	$F_0 > F_{\alpha, n_2-1, n_1-1}$
$H_0: \sigma_1^2 = \sigma_2^2$ $H_1: \sigma_1^2 > \sigma_2^2$	$F_0 = \frac{S_1^2}{S_2^2}$	$F_0 > F_{\alpha, n_1-1, n_2-1}$

ERGONOMICS

US Civilian Body Dimensions, Female/Male, for Ages 20 to 60 Years				
(Centimeters)				
	Percentiles			
	5th	50th	95th	Std. Dev.
HEIGHTS				
Stature (height)	149.5 / 161.8	160.5 / 173.6	171.3 / 184.4	6.6 / 6.9
Eye height	138.3 / 151.1	148.9 / 162.4	159.3 / 172.7	6.4 / 6.6
Shoulder (acromion) height	121.1 / 132.3	131.1 / 142.8	141.9 / 152.4	6.1 / 6.1
Elbow height	93.6 / 100.0	101.2 / 109.9	108.8 / 119.0	4.6 / 5.8
Knuckle height	64.3 / 69.8	70.2 / 75.4	75.9 / 80.4	3.5 / 3.2
Height, sitting	78.6 / 84.2	85.0 / 90.6	90.7 / 96.7	3.5 / 3.7
Eye height, sitting	67.5 / 72.6	73.3 / 78.6	78.5 / 84.4	3.3 / 3.6
Shoulder height, sitting	49.2 / 52.7	55.7 / 59.4	61.7 / 65.8	3.8 / 4.0
Elbow rest height, sitting	18.1 / 19.0	23.3 / 24.3	28.1 / 29.4	2.9 / 3.0
Knee height, sitting	45.2 / 49.3	49.8 / 54.3	54.5 / 59.3	2.7 / 2.9
Popliteal height, sitting	35.5 / 39.2	39.8 / 44.2	44.3 / 48.8	2.6 / 2.8
Thigh clearance height	10.6 / 11.4	13.7 / 14.4	17.5 / 17.7	1.8 / 1.7
DEPTHS				
Chest depth	21.4 / 21.4	24.2 / 24.2	29.7 / 27.6	2.5 / 1.9
Elbow-fingertip distance	38.5 / 44.1	42.1 / 47.9	46.0 / 51.4	2.2 / 2.2
Buttock-knee distance, sitting	51.8 / 54.0	56.9 / 59.4	62.5 / 64.2	3.1 / 3.0
Buttock-popliteal distance, sitting	43.0 / 44.2	48.1 / 49.5	53.5 / 54.8	3.1 / 3.0
Forward reach, functional	64.0 / 76.3	71.0 / 82.5	79.0 / 88.3	4.5 / 5.0
BREADTHS				
Elbow-to-elbow breadth	31.5 / 35.0	38.4 / 41.7	49.1 / 50.6	5.4 / 4.6
Hip breadth, sitting	31.2 / 30.8	36.4 / 35.4	43.7 / 40.6	3.7 / 2.8
HEAD DIMENSIONS				
Head breadth	13.6 / 14.4	14.54 / 15.42	15.5 / 16.4	0.57 / 0.59
Head circumference	52.3 / 53.8	54.9 / 56.8	57.7 / 59.3	1.63 / 1.68
Interpupillary distance	5.1 / 5.5	5.83 / 6.20	6.5 / 6.8	0.4 / 0.39
HAND DIMENSIONS				
Hand length	16.4 / 17.6	17.95 / 19.05	19.8 / 20.6	1.04 / 0.93
Breadth, metacarpal	7.0 / 8.2	7.66 / 8.88	8.4 / 9.8	0.41 / 0.47
Circumference, metacarpal	16.9 / 19.9	18.36 / 21.55	19.9 / 23.5	0.89 / 1.09
Thickness, metacarpal III	2.5 / 2.4	2.77 / 2.76	3.1 / 3.1	0.18 / 0.21
Digit 1				
Breadth, interphalangeal	1.7 / 2.1	1.98 / 2.29	2.1 / 2.5	0.12 / 0.13
Crotch-tip length	4.7 / 5.1	5.36 / 5.88	6.1 / 6.6	0.44 / 0.45
Digit 2				
Breadth, distal joint	1.4 / 1.7	1.55 / 1.85	1.7 / 2.0	0.10 / 0.12
Crotch-tip length	6.1 / 6.8	6.88 / 7.52	7.8 / 8.2	0.52 / 0.46
Digit 3				
Breadth, distal joint	1.4 / 1.7	1.53 / 1.85	1.7 / 2.0	0.09 / 0.12
Crotch-tip length	7.0 / 7.8	7.77 / 8.53	8.7 / 9.5	0.51 / 0.51
Digit 4				
Breadth, distal joint	1.3 / 1.6	1.42 / 1.70	1.6 / 1.9	0.09 / 0.11
Crotch-tip length	6.5 / 7.4	7.29 / 7.99	8.2 / 8.9	0.53 / 0.47
Digit 5				
Breadth, distal joint	1.2 / 1.4	1.32 / 1.57	1.5 / 1.8	0.09 / 0.12
Crotch-tip length	4.8 / 5.4	5.44 / 6.08	6.2 / 6.99	0.44 / 0.47
FOOT DIMENSIONS				
Foot length	22.3 / 24.8	24.1 / 26.9	26.2 / 29.0	1.19 / 1.28
Foot breadth	8.1 / 9.0	8.84 / 9.79	9.7 / 10.7	0.50 / 0.53
Lateral malleolus height	5.8 / 6.2	6.78 / 7.03	7.8 / 8.0	0.59 / 0.54
Weight (kg)	46.2 / 56.2	61.1 / 74.0	89.9 / 97.1	13.8 / 12.6

ERGONOMICS—HEARING

The average shifts with age of the threshold of hearing for pure tones of persons with "normal" hearing, using a 25-year-old group as a reference group.

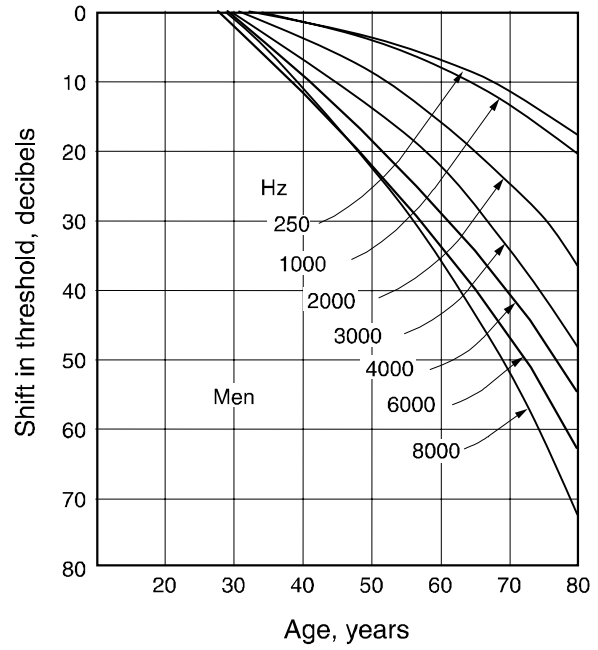
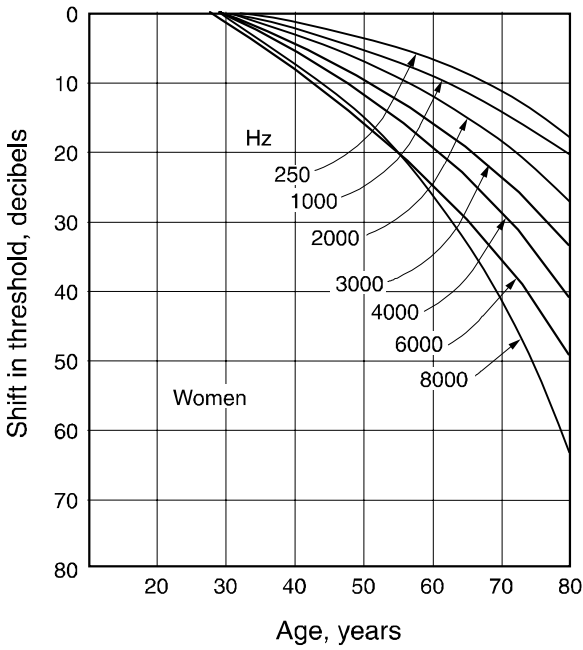

Equivalent sound-level contours used in determining the A-weighted sound level on the basis of an octave-band analysis. The curve at the point of the highest penetration of the noise spectrum reflects the A-weighted sound level.

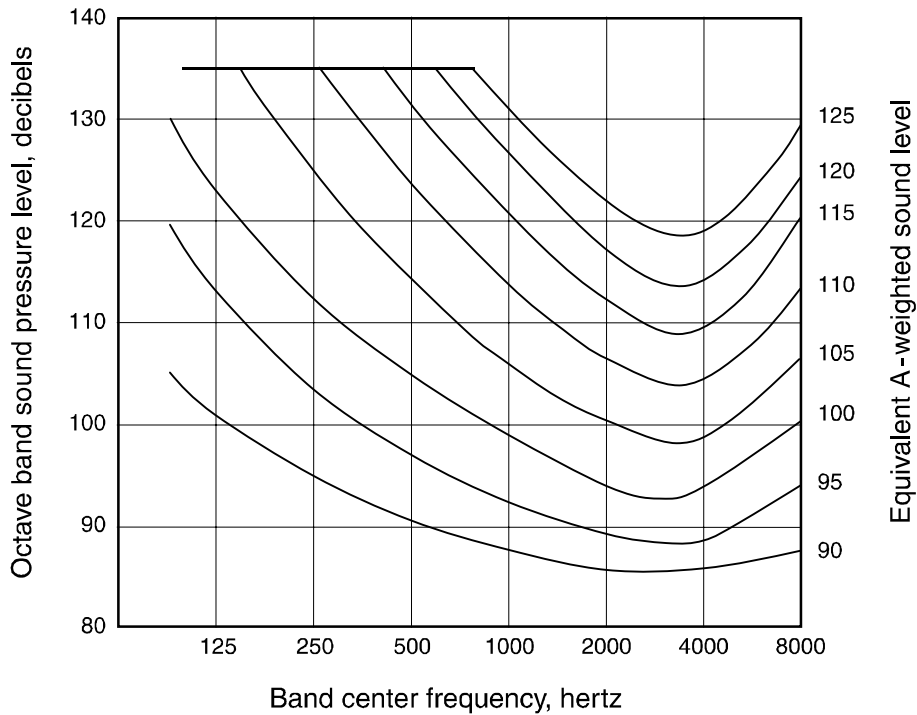

Estimated average trend curves for net hearing loss at 1,000, 2,000, and 4,000 Hz after continuous exposure to steady noise. Data are corrected for age, but not for temporary threshold shift. Dotted portions of curves represent extrapolation from available data.

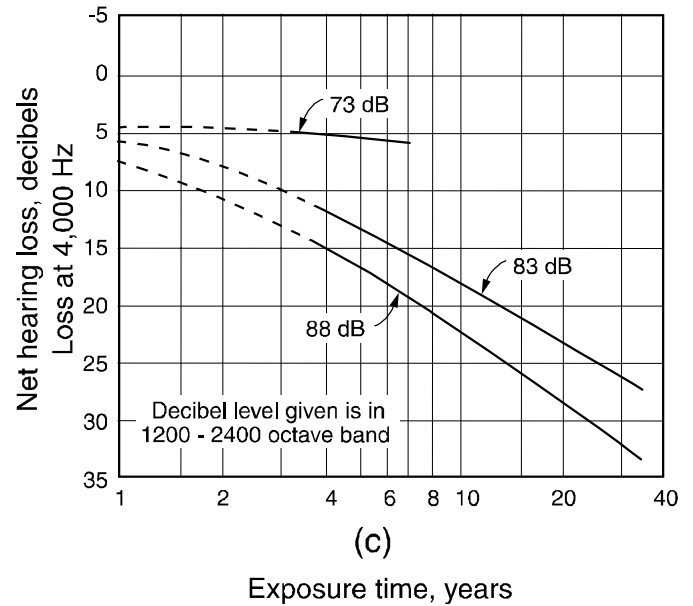
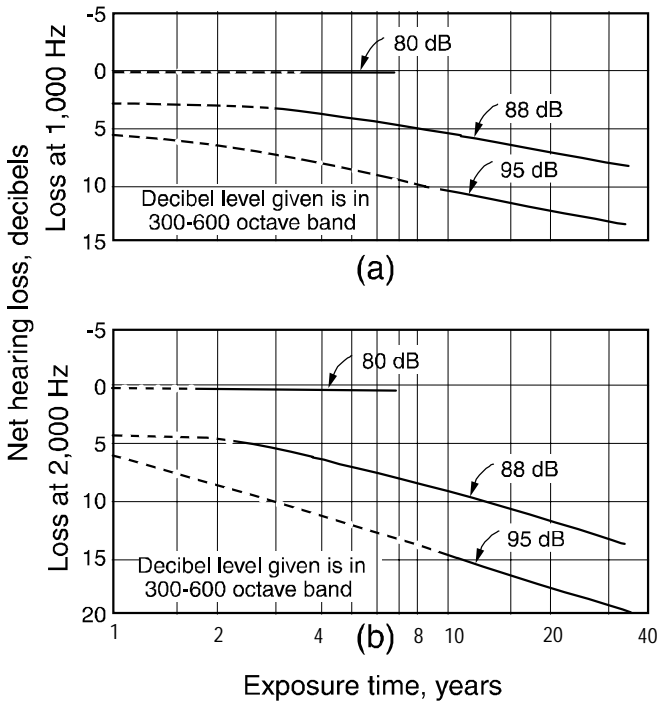

Tentative upper limit of effective temperature (ET) for unimpaired mental performance as related to exposure time; data are based on an analysis of 15 studies. Comparative curves of tolerable and marginal physiological limits are also given.

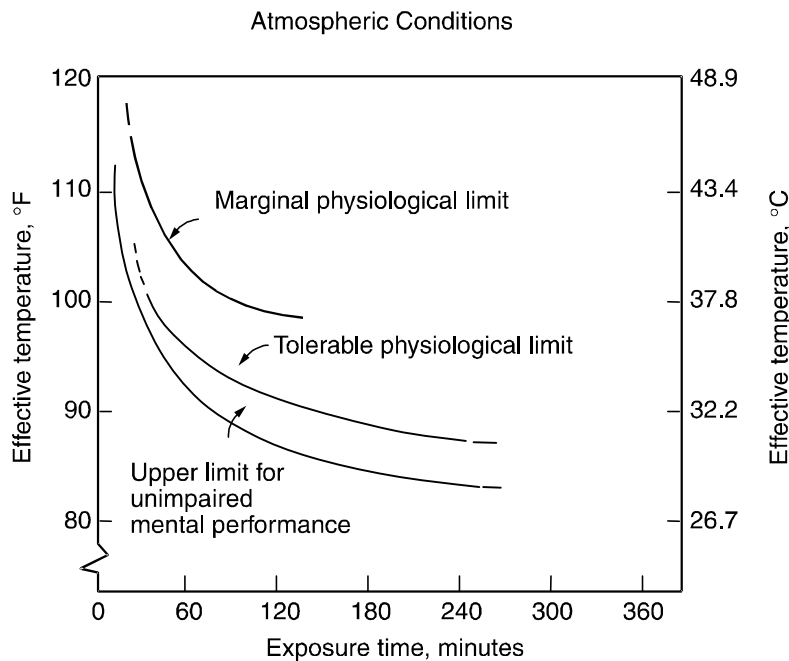

MECHANICAL ENGINEERING

Examinees should also review the material in sections titled **HEAT TRANSFER, THERMODYNAMICS, TRANSPORT PHENOMENA, FLUID MECHANICS, and COMPUTERS, MEASUREMENT, AND CONTROLS.**

REFRIGERATION AND HVAC

Two-Stage Cycle

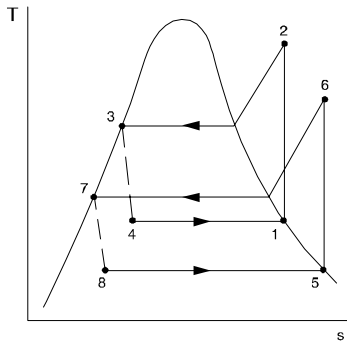
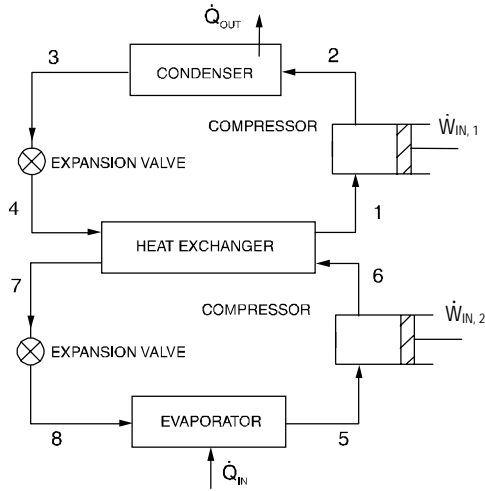

The following equations are valid if the mass flows are the same in each stage.

$$COP_{ref} = \frac{\dot{Q}_{in}}{\dot{W}_{in,1} + \dot{W}_{in,2}} = \frac{h_5 - h_8}{h_2 - h_1 + h_6 - h_5}$$

$$COP_{HP} = \frac{\dot{Q}_{out}}{\dot{W}_{in,1} + \dot{W}_{in,2}} = \frac{h_5 - h_3}{h_2 - h_1 + h_6 - h_5}$$

Air Refrigeration Cycle

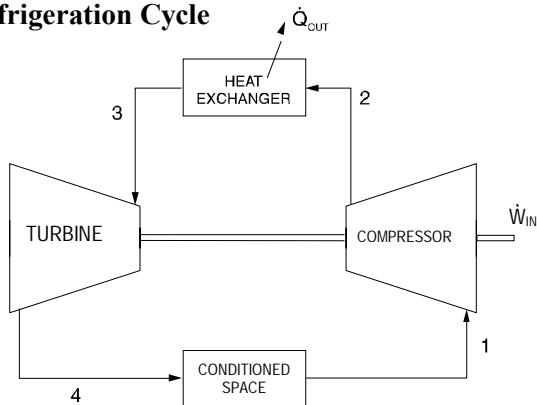

Cooling and Dehumidification

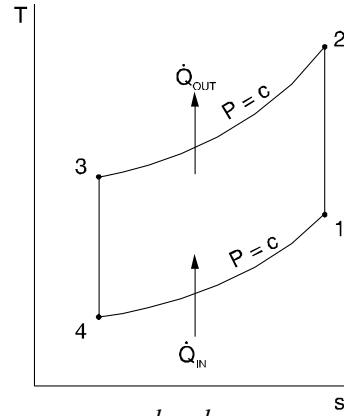
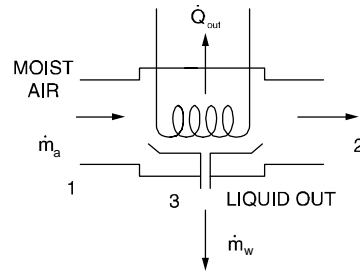

$$COP_{ref} = \frac{h_1 - h_4}{(h_2 - h_1) - (h_3 - h_4)}$$

$$COP_{HP} = \frac{h_2 - h_3}{(h_2 - h_1) - (h_3 - h_4)}$$

(see also **THERMODYNAMICS** section)

HVAC—Pure Heating and Cooling

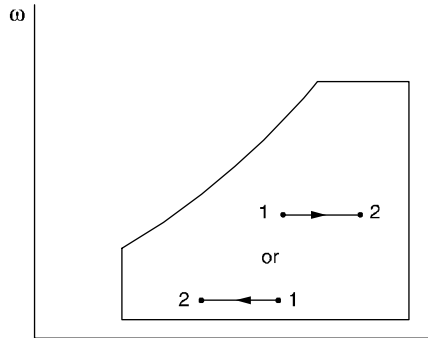
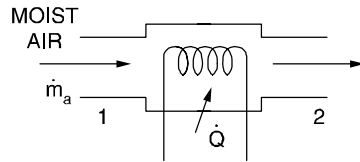

$$\dot{Q} = \dot{m}_a (h_2 - h_1) = \dot{m}_a C_{pm} (T_2 - T_1)$$

$$C_{pm} = 1.02 \text{ kJ}/(\text{kg} \cdot ^\circ\text{C})$$

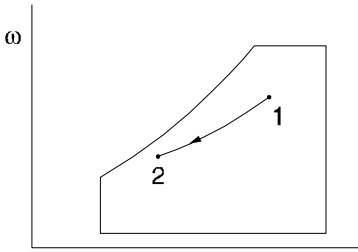

$$\dot{Q}_{out} = \dot{m}_a [(h_1 - h_2) - h_{f3}(\omega_1 - \omega_2)]$$

$$\dot{m}_w = \dot{m}_a (\omega_1 - \omega_2)$$

Heating and Humidification

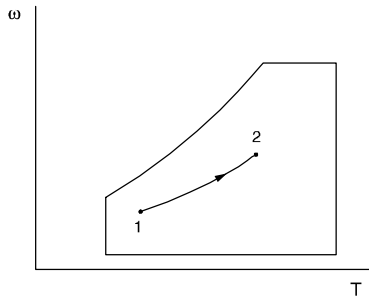
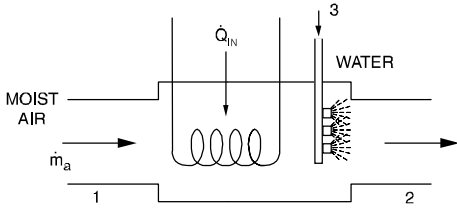

$$\dot{Q}_{in} = \dot{m}_a [(h_2 - h_1) + h_3(\omega_2 - \omega_1)]$$

$$\dot{m}_w = \dot{m}_a (\omega_2 - \omega_1)$$

Adiabatic Humidification (evaporative cooling)

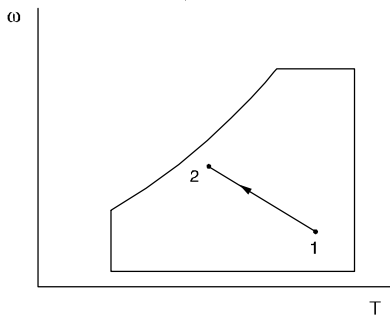
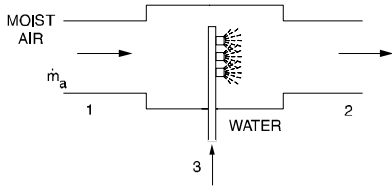

$$h_2 = h_1 + h_3(\omega_2 - \omega_1)$$

$$\dot{m}_w = \dot{m}_a (\omega_2 - \omega_1)$$

$$h_3 = h_f \text{ at } T_{wb}$$

Adiabatic Mixing

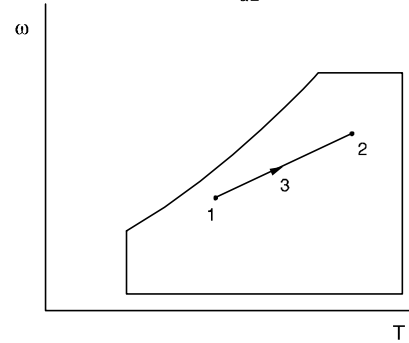
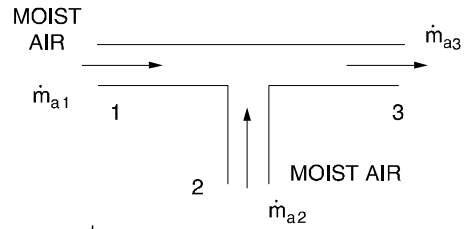

$$\dot{m}_{a3} = \dot{m}_{a1} + \dot{m}_{a2}$$

$$h_3 = \frac{\dot{m}_{a1}h_1 + \dot{m}_{a2}h_2}{\dot{m}_{a3}}$$

$$\omega_3 = \frac{\dot{m}_{a1}\omega_1 + \dot{m}_{a2}\omega_2}{\dot{m}_{a3}}$$

distance $\bar{13} = \frac{\dot{m}_{a2}}{\dot{m}_{a3}} \times$ distance $\bar{12}$ measured on psychrometric chart

Heating Load

(see also HEAT TRANSFER section)

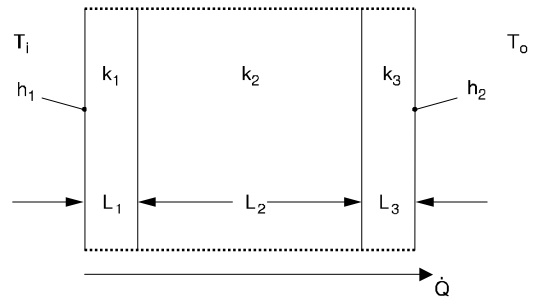

$$\dot{Q} = A(T_i - T_o) / R''$$

$$R'' = \frac{1}{h_1} + \frac{L_1}{k_1} + \frac{L_2}{k_2} + \frac{L_3}{k_3} + \frac{1}{h_2}, \text{ where}$$

\dot{Q} = heat transfer rate,
 A = wall surface area, and
 R'' = thermal resistance.

Overall heat transfer coefficient = U

$$U = 1/R''$$

$$\dot{Q} = UA (T_i - T_o)$$

Cooling Load

$$\dot{Q} = UA \text{ (CLTD)}, \text{ where}$$

CLTD = effective temperature difference.

CLTD depends on solar heating rate, wall or roof orientation, color, and time of day.

Infiltration

Air change method

$$\dot{Q} = \frac{\rho_a c_p V n_{AC}}{3,600} (T_i - T_o), \text{ where}$$

ρ_a = air density,

c_p = air specific heat,

V = room volume,

n_{AC} = number of air changes per hour,

T_i = indoor temperature, and

T_o = outdoor temperature.

Crack method

$$\dot{Q} = 1.2CL(T_i - T_o)$$

where

C = coefficient, and

L = crack length.

FANS, PUMPS, AND COMPRESSORS

Scaling Laws

(see page 44 on Similitude)

$$\left(\frac{Q}{ND^3} \right)_2 = \left(\frac{Q}{ND^3} \right)_1$$

$$\left(\frac{\dot{m}}{\rho ND^3} \right)_2 = \left(\frac{\dot{m}}{\rho ND^3} \right)_1$$

$$\left(\frac{H}{N^2 D^2} \right)_2 = \left(\frac{H}{N^2 D^2} \right)_1$$

$$\left(\frac{P}{\rho N^2 D^2} \right)_2 = \left(\frac{P}{\rho N^2 D^2} \right)_1$$

$$\left(\frac{\dot{W}}{\rho N^3 D^5} \right)_2 = \left(\frac{\dot{W}}{\rho N^3 D^5} \right)_1$$

where

Q = volumetric flow rate,

\dot{m} = mass flow rate,

H = head,

P = pressure rise,

\dot{W} = power,

ρ = fluid density,

N = rotational speed, and

D = impeller diameter.

Subscripts 1 and 2 refer to different but similar machines or to different operating conditions of the same machine.

Fan Characteristics

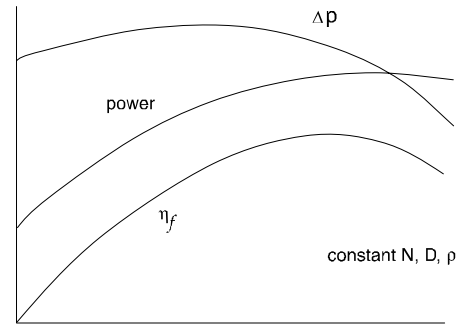

Typical Fan Curves
backward curved

$$\dot{W} = \frac{\Delta P Q}{\eta_f}, \text{ where}$$

\dot{W} = fan power,

ΔP = pressure rise, and

η_f = fan efficiency.

Pump Characteristics

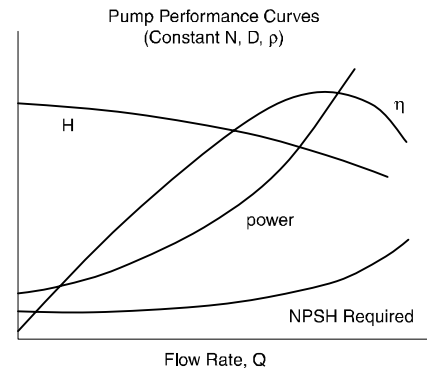

Net Positive Suction Head (NPSH)

$$NPSH = \frac{P_i}{\rho g} + \frac{V_i^2}{2g} - \frac{P_v}{\rho g}, \text{ where}$$

P_i = inlet pressure to pump,

V_i = velocity at inlet to pump, and

P_v = vapor pressure of fluid being pumped.

$$\dot{W} = \frac{\rho g H Q}{\eta}, \text{ where}$$

\dot{W} = pump power,

η = pump efficiency, and

H = head increase.

Compressor Characteristics

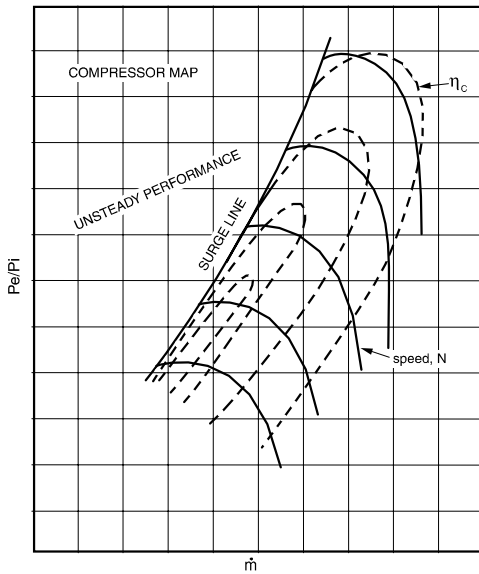

where

\dot{m} = mass flow rate and

P_e/P_i = exit to inlet pressure ratio.

$$\dot{W} = \dot{m} \left(h_e - h_i + \frac{V_e^2 - V_i^2}{2} \right)$$

$$= \dot{m} \left(c_p (T_e - T_i) + \frac{V_e^2 - V_i^2}{2} \right)$$

where

\dot{W} = input power,

h_e, h_i = exit, inlet enthalpy,

V_e, V_i = exit, inlet velocity,

c_p = specific heat at constant pressure, and

T_e, T_i = exit, inlet temperature.

$$h_e = h_i + \frac{h_{es} - h_i}{\eta}$$

$$T_e = T_i + \frac{T_{es} - T_i}{\eta}, \text{ where}$$

h_{es} = exit enthalpy after isentropic compression,

T_{es} = exit temperature after isentropic compression, and

η = compression efficiency.

ENERGY CONVERSION AND POWER PLANTS

(see also **THERMODYNAMICS** section)

Internal Combustion Engines

OTTO CYCLE (see **THERMODYNAMICS** section)

Diesel Cycle

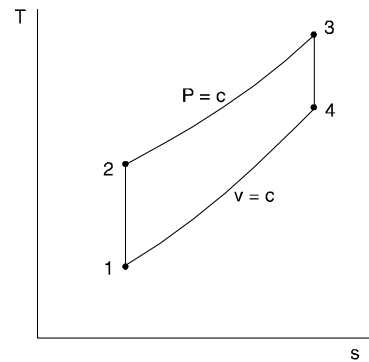
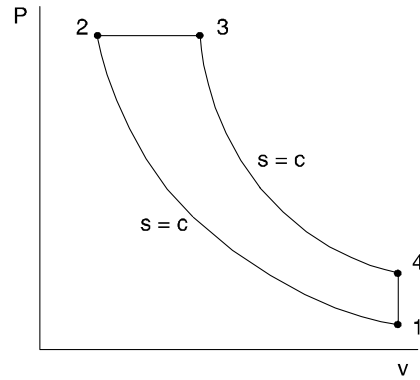

$$r = V_1/V_2$$

$$r_c = V_3/V_2$$

$$\eta = 1 - \frac{1}{r^{k-1}} \left[\frac{r_c^k - 1}{k(r_c - 1)} \right]$$

$$k = c_p/c_v$$

Brake Power

$$\dot{W}_b = 2\pi TN = 2\pi FRN, \text{ where}$$

\dot{W}_b = brake power (W),

T = torque (N·m),

N = rotation speed (rev/s),

F = force at end of brake arm (N), and

R = length of brake arm (m).

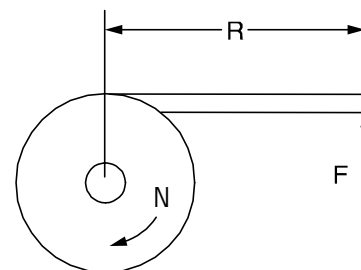

Indicated Power

$$\dot{W}_i = \dot{W}_b + \dot{W}_f, \text{ where}$$

\dot{W}_i = indicated power (W), and

\dot{W}_f = friction power (W).

Brake Thermal Efficiency

$$\eta_b = \frac{\dot{W}_b}{\dot{m}_f(HV)}, \text{ where}$$

η_b = brake thermal efficiency,

\dot{m}_f = fuel consumption rate (kg/s), and

HV = heating value of fuel (J/kg).

Indicated Thermal Efficiency

$$\eta_i = \frac{\dot{W}_i}{\dot{m}_f(HV)}$$

Mechanical Efficiency

$$\eta_m = \frac{\dot{W}_b}{\dot{W}_i} = \frac{\eta_b}{\eta_i}$$

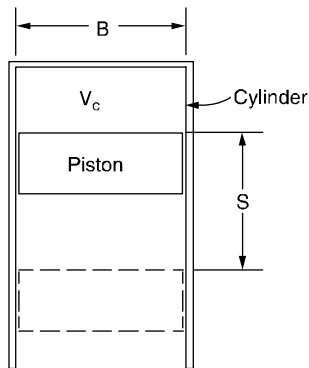

Displacement Volume

$$V_d = \pi B^2 S, \text{ m}^3 \text{ for each cylinder}$$

$$\text{Total volume} = V_t = V_d + V_c, \text{ m}^3$$

V_c = clearance volume (m^3).

Compression Ratio

$$r_c = V_t/V_c$$

Mean Effective Pressure (MEP)

$$mep = \frac{\dot{W}n_s}{V_d n_c N}, \text{ where}$$

n_s = number of crank revolutions per power stroke,

n_c = number of cylinders, and

V_d = displacement volume per cylinder.

mep can be based on brake power ($bmep$), indicated power ($imep$), or friction power ($fmeep$).

Volumetric Efficiency

$$\eta_v = \frac{2\dot{m}_a}{\rho_a V_d n_c N} \text{ (four-stroke cycles only)}$$

where

\dot{m}_a = mass flow rate of air into engine (kg/s), and

ρ_a = density of air (kg/m^3).

Specific Fuel Consumption (SFC)

$$sfc = \frac{\dot{m}_f}{\dot{W}} = \frac{1}{\eta HV}, \text{ kg/J}$$

Use η_b and \dot{W}_b for $bsfc$ and η_i and \dot{W}_i for $isfc$.

Gas Turbines

Brayton Cycle (Steady-Flow Cycle)

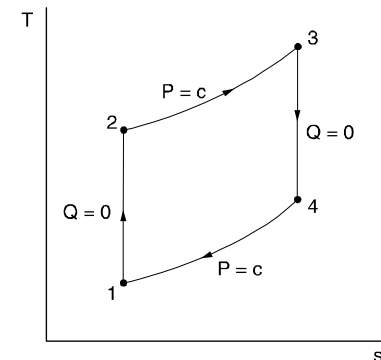
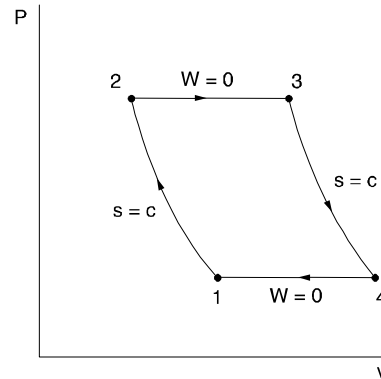
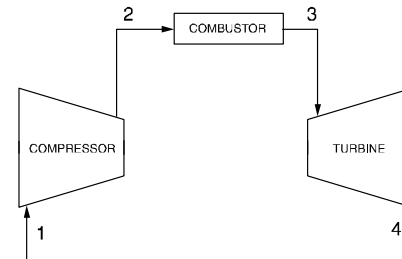

$$w_{12} = h_1 - h_2 = c_p (T_1 - T_2)$$

$$w_{34} = h_3 - h_4 = c_p (T_3 - T_4)$$

$$w_{\text{net}} = w_{12} + w_{34}$$

$$q_{23} = h_3 - h_2 = c_p (T_3 - T_2)$$

$$q_{41} = h_1 - h_4 = c_p (T_1 - T_4)$$

$$q_{\text{net}} = q_{23} + q_{41}$$

$$\eta = w_{\text{net}}/q_{23}$$

Brayton Cycle With Regeneration

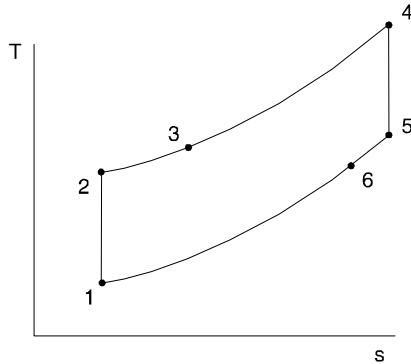
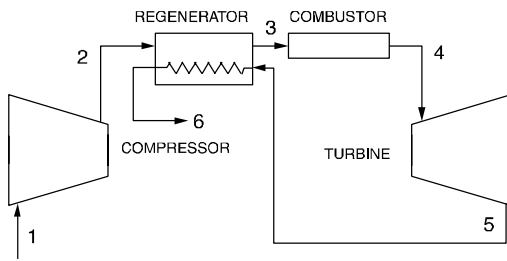

$$h_3 - h_2 = h_5 - h_6 \quad \text{or} \quad T_3 - T_2 = T_5 - T_6$$

$$q_{34} = h_4 - h_3 = c_p (T_4 - T_3)$$

$$q_{56} = h_6 - h_5 = c_p (T_6 - T_5)$$

$$\eta = w_{net} / q_{34}$$

Regenerator efficiency

$$\eta_{reg} = \frac{h_3 - h_2}{h_5 - h_2} = \frac{T_3 - T_2}{T_5 - T_2}$$

$$h_3 = h_2 + \eta_{reg} (h_5 - h_2)$$

or $T_3 = T_2 + \eta_{reg} (T_5 - T_2)$

Steam Power Plants

Feedwater Heaters

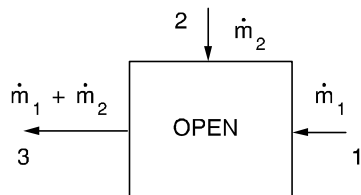

$$\dot{m}_1 h_1 + \dot{m}_2 h_2 = h_3 (\dot{m}_1 + \dot{m}_2)$$

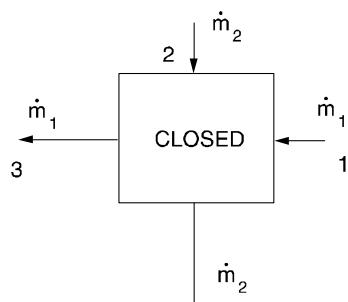

$$\dot{m}_1 h_1 + \dot{m}_2 h_2 = \dot{m}_1 h_3 + \dot{m}_2 h_4$$

Steam Trap

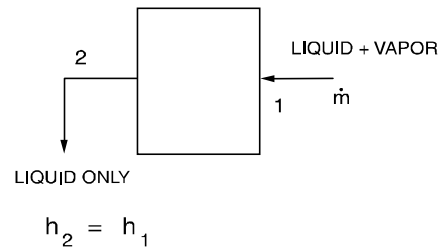

$$h_2 = h_1$$

Junction

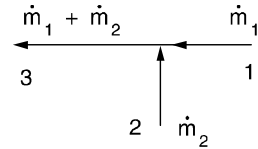

$$\dot{m}_1 h_1 + \dot{m}_2 h_2 = h_3 (\dot{m}_1 + \dot{m}_2)$$

Pump

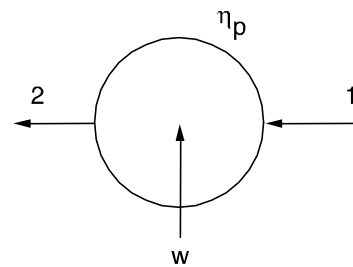

$$w = h_1 - h_2 = (h_1 - h_{2s}) / \eta_p$$

$$h_{2s} - h_1 = v(P_2 - P_1)$$

$$w = - \frac{v(P_2 - P_1)}{\eta_p}$$

MACHINE DESIGN

Variable Loading Failure Theories

Modified Goodman Theory: The modified Goodman criterion states that a fatigue failure will occur whenever

$$\frac{\sigma_a}{S_e} + \frac{\sigma_m}{S_{ut}} \geq 1 \quad \text{or} \quad \frac{\sigma_{max}}{S_y} \geq 1, \quad \sigma_m \geq 0, \quad \text{where}$$

S_e = fatigue strength,

S_{ut} = ultimate strength,

S_y = yield strength,

σ_a = alternating stress, and

σ_m = mean stress.

$$\sigma_{max} = \sigma_m + \sigma_a$$

Soderberg Theory: The Soderberg theory states that a fatigue failure will occur whenever

$$\frac{\sigma_a}{S_e} + \frac{\sigma_m}{S_y} \geq 1, \quad \sigma_m \geq 0$$

Endurance Limit: When test data is unavailable, the endurance limit for steels may be estimated as

$$S'_e = \begin{cases} 0.5 S_{ut}, & S_{ut} \leq 1,400 \text{ MPa} \\ 700 \text{ MPa}, & S_{ut} > 1,400 \text{ MPa} \end{cases}$$

Endurance Limit Modifying Factors: Endurance limit modifying factors are used to account for the differences between the endurance limit as determined from a rotating beam test, S'_e , and that which would result in the real part, S_e .

$$S_e = k_a k_b k_c k_d k_e S'_e$$

where

Surface Factor, k_a : $k_a = aS_{ut}^b$

Surface Finish	Factor a		Exponent b
	kpsi	MPa	
Ground	1.34	1.58	-0.085
Machined or CD	2.70	4.51	-0.265
Hot rolled	14.4	57.7	-0.718
As forged	39.9	272.0	-0.995

Size Factor, k_b :

For bending and torsion:

$$\begin{aligned} d \leq 8 \text{ mm}; & & k_b &= 1 \\ 8 \text{ mm} \leq d \leq 250 \text{ mm}; & & k_b &= 1.189d_{\text{eff}}^{-0.097} \\ d > 250 \text{ mm}; & & 0.6 \leq k_b &\leq 0.75 \end{aligned}$$

For axial loading: $k_b = 1$

Load Factor, k_c :

$$\begin{aligned} k_c &= 0.923 && \text{axial loading, } S_{ut} \leq 1520 \text{ MPa} \\ k_c &= 1 && \text{axial loading, } S_{ut} > 1520 \text{ MPa} \\ k_c &= 1 && \text{bending} \end{aligned}$$

Temperature Factor, k_d :

$$\text{for } T \leq 450^\circ \text{ C, } k_d = 1$$

Miscellaneous Effects Factor, k_e : Used to account for strength reduction effects such as corrosion, plating, and residual stresses. In the absence of known effects, use $k_e = 1$.

Shafts and Axles

Static Loading: The maximum shear stress and the von Mises stress may be calculated in terms of the loads from

$$\tau_{\max} = \frac{2}{\pi d^3} \left[(8M + Fd)^2 + (8T)^2 \right]^{1/2},$$

$$\sigma' = \frac{4}{\pi d^3} \left[(8M + Fd)^2 + 48T^2 \right]^{1/2}, \text{ where}$$

M = the bending moment,

F = the axial load,

T = the torque, and

d = the diameter.

Fatigue Loading: Using the maximum-shear-stress theory combined with the Soderberg line for fatigue, the diameter and safety factor are related by

$$\frac{\pi d^3}{32} = n \left[\left(\frac{M_m}{S_y} + \frac{K_f M_a}{S_e} \right)^2 + \left(\frac{T_m}{S_y} + \frac{K_{fs} T_a}{S_e} \right)^2 \right]^{1/2}$$

where

d = diameter,

n = safety factor,

M_a = alternating moment,

M_m = mean moment,

T_a = alternating torque,

T_m = mean torque,

S_e = fatigue limit,

S_y = yield strength,

K_f = fatigue strength reduction factor, and

K_{fs} = fatigue strength reduction factor for shear.

Screws, Fasteners, and Connections

Square Thread Power Screws: The torque required to raise, T_R , or to lower, T_L , a load is given by

$$T_R = \frac{F d_m}{2} \left(\frac{l + \pi \mu d_m}{\pi d_m - \mu l} \right) + \frac{F \mu_c d_c}{2},$$

$$T_L = \frac{F d_m}{2} \left(\frac{\pi \mu d_m - l}{\pi d_m + \mu l} \right) + \frac{F \mu_c d_c}{2}, \text{ where}$$

d_c = mean collar diameter,

d_m = mean thread diameter,

l = lead,

F = load,

μ = coefficient of friction for thread, and

μ_c = coefficient of friction for collar.

The efficiency of a power screw may be expressed as

$$\eta = Fl / (2\pi T)$$

Threaded Fasteners: The load carried by a bolt in a threaded connection is given by

$$F_b = CP + F_i \quad F_m < 0$$

while the load carried by the members is

$$F_m = (1 - C)P - F_i \quad F_m < 0, \text{ where}$$

C = joint coefficient,

$$= k_b / (k_b + k_m)$$

F_b = total bolt load,

F_i = bolt preload,

F_m = total material load,

P = externally applied load,

k_b = the effective stiffness of the bolt or fastener in the grip, and

k_m = the effective stiffness of the members in the grip.

Bolt stiffness may be calculated from

$$k_b = \frac{A_d A_t E}{A_d l_t + A_t l_d}, \text{ where}$$

A_d = major-diameter area,

A_t = tensile-stress area,

E = modulus of elasticity,

l_d = length of unthreaded shank, and

l_t = length of threaded shank contained within the grip.

If all members within the grip are of the same material, member stiffness may be obtained from

$$k_m = dEAe^{b(d/l)}, \text{ where}$$

d = bolt diameter,

E = modulus of elasticity of members, and

l = grip length.

Coefficient A and b are given in the table below for various joint member materials.

Material	A	b
Steel	0.78715	0.62873
Aluminum	0.79670	0.63816
Copper	0.79568	0.63553
Gray cast iron	0.77871	0.61616

The approximate tightening torque required for a given preload F_i and for a steel bolt in a steel member is given by $T = 0.2 F_i d$.

Threaded Fasteners—Design Factors: The bolt load factor is

$$n_b = (S_p A_t - F_i) / CP$$

The factor of safety guarding against joint separation is

$$n_s = F_i / [P(1 - C)]$$

Threaded Fasteners—Fatigue Loading: If the externally applied load varies between zero and P , the alternating stress is

$$\sigma_a = CP / (2A_t)$$

and the mean stress is

$$\sigma_m = \sigma_a + F_i / A_t$$

Bolted and Riveted Joints Loaded in Shear:

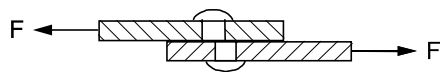

(a) FASTENER IN SHEAR

Failure by pure shear, (a)

$$\tau = F/A, \text{ where}$$

F = shear load, and

A = cross-sectional area of bolt or rivet.

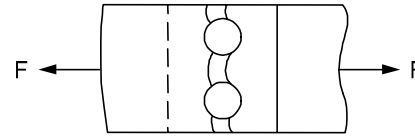

(b) MEMBER RUPTURE

Failure by rupture, (b)

$$\sigma = F/A, \text{ where}$$

F = load and

A = net cross-sectional area of thinnest member.

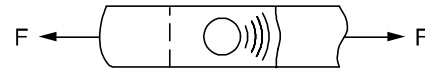

(c) MEMBER OR FASTENER CRUSHING

Failure by crushing of rivet or member, (c)

$$\sigma = F/A, \text{ where}$$

F = load and

A = projected area of a single rivet.

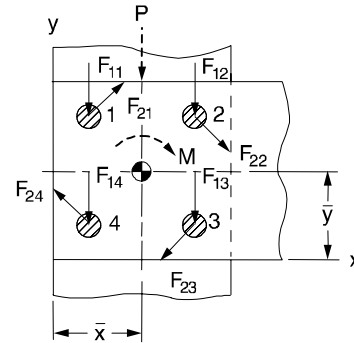

(d) FASTENER GROUPS

Fastener groups in shear, (d).

The location of the centroid of a fastener group with respect to any convenient coordinate frame is:

$$\bar{x} = \frac{\sum_{i=1}^n A_i x_i}{\sum_{i=1}^n A_i}, \quad \bar{y} = \frac{\sum_{i=1}^n A_i y_i}{\sum_{i=1}^n A_i}, \text{ where}$$

n = total number of fasteners,

i = the index number of a particular fastener,

A_i = cross-sectional area of the i th fastener,

x_i = x -coordinate of the center of the i th fastener, and

y_i = y -coordinate of the center of the i th fastener.

The total shear force on a fastener is the **vector** sum of the force due to direct shear P and the force due to the moment M acting on the group at its centroid.

The magnitude of the direct shear force due to P is

$$|F_{1i}| = \frac{P}{n}$$

This force acts in the same direction as P .

The magnitude of the shear force due to M is

$$|F_{2i}| = \frac{Mr_i}{\sum_{i=1}^n r_i^2}$$

This force acts perpendicular to a line drawn from the group centroid to the center of a particular fastener. Its sense is such that its moment is in the same direction (CW or CCW) as M .

Mechanical Springs

Helical Linear Springs: The shear stress in a helical linear spring is

$$\tau = K_s \frac{8FD}{\pi d^3}, \text{ where}$$

d = wire diameter,

F = applied force,

D = mean spring diameter

$K_s = (2C + 1)/(2C)$, and

$C = D/d$.

The deflection and force are related by $F = kx$ where the spring rate (spring constant) k is given by

$$k = \frac{d^4 G}{8D^3 N}$$

where G is the shear modulus of elasticity and N is the number of active coils. See Table of Material Properties at the end of the **MECHANICS OF MATERIALS** section for values of G .

Spring Material: The minimum tensile strength of common spring steels may be determined from

$$S_{ut} = A/d^m$$

where S_{ut} is the tensile strength in MPa, d is the wire diameter in millimeters, and A and m are listed in the following table.

Material	ASTM	m	A
Music wire	A228	0.163	2060
Oil-tempered wire	A229	0.193	1610
Hard-drawn wire	A227	0.201	1510
Chrome vanadium	A232	0.155	1790
Chrome silicon	A401	0.091	1960

Maximum allowable torsional stress for static applications may be approximated as

$$S_{sy} = \tau = 0.45S_{ut} \text{ cold-drawn carbon steel (A227, A228, A229)}$$

$$S_{sy} = \tau = 0.50S_{ut} \text{ hardened and tempered carbon and low-alloy steels (A232, A401)}$$

Compression Spring Dimensions

Term	Type of Spring Ends	
	Plain	Plain and Ground
End coils, N_e	0	1
Total coils, N_t	N	$N + 1$
Free length, L_0	$pN + d$	$p(N + 1)$
Solid length, L_s	$d(N_t + 1)$	dN_t
Pitch, p	$(L_0 - d)/N$	$L_0/(N + 1)$

Term	Squared or Ground	
	Closed	and Ground
End coils, N_e	2	2
Total coils, N_t	$N + 2$	$N + 2$
Free length, L_0	$pN + 3d$	$pN + 2d$
Solid length, L_s	$d(N_t + 1)$	dN_t
Pitch, p	$(L_0 - 3d)/N$	$(L_0 - 2d)/N$

Helical Torsion Springs: The bending stress is given as

$$\sigma = K_i [32Fr/(\pi d^3)]$$

where F is the applied load and r is the radius from the center of the coil to the load.

K_i = correction factor

$$= (4C^2 - C - 1) / [4C(C - 1)]$$

$C = D/d$

The deflection θ and moment Fr are related by

$$Fr = k\theta$$

where the spring rate k is given by

$$k = \frac{d^4 E}{64DN}$$

where k has units of N·m/rad and θ is in radians.

Spring Material: The strength of the spring wire may be found as was done in the section on linear springs. The allowable stress σ is then given by

$$S_y = \sigma = 0.78S_{ut} \text{ cold-drawn carbon steel (A227, A228, A229)}$$

$$S_y = \sigma = 0.87S_{ut} \text{ hardened and tempered carbon and low-alloy steel (A232, A401)}$$

Ball/Roller Bearing Selection

The minimum required *basic load rating* (load for which 90% of the bearings from a given population will survive 1 million revolutions) is given by

$$C = PL^a, \text{ where}$$

C = minimum required basic load rating,

P = design radial load,

L = design life (in millions of revolutions), and

a = 3 for ball bearings, 10/3 for roller bearings.

When a ball bearing is subjected to both radial and axial loads, an equivalent radial load must be used in the equation above. The equivalent radial load is

$$P_{eq} = XVF_r + YF_a, \text{ where}$$

P_{eq} = equivalent radial load,

F_r = applied constant radial load, and

F_a = applied constant axial (thrust) load.

For radial contact, groove ball bearings:

$V = 1$ if inner ring rotating, 1.2 outer ring rotating,

If $F_a/(VF_r) > e$,

$$X = 0.56, \text{ and } Y = 0.840 \left(\frac{F_a}{C_o} \right)^{-0.247}$$

$$\text{where } e = 0.513 \left(\frac{F_a}{C_o} \right)^{0.236}, \text{ and}$$

C_o = basic static load rating, from bearing catalog.

If $F_a/(VF_r) \leq e$, $X = 1$ and $Y = 0$.

Press/Shrink Fits

The interface pressure induced by a press/shrink fit is

$$p = \frac{0.5\delta}{\frac{r}{E_o} \left(\frac{r_o^2 + r^2}{r_o^2 - r^2} + \nu_o \right) + \frac{r}{E_i} \left(\frac{r^2 + r_i^2}{r^2 - r_i^2} + \nu_i \right)}$$

where the subscripts i and o stand for the inner and outer member, respectively, and

p = inside pressure on the outer member and outside pressure on the inner member,

δ = the diametral interference,

r = nominal interference radius,

r_i = inside radius of inner member,

r_o = outside radius of outer member,

E = Young's modulus of respective member, and

ν = Poisson's ratio of respective member.

See the **MECHANICS OF MATERIALS** section on thick-wall cylinders for the stresses at the interface.

The maximum torque that can be transmitted by a press fit joint is approximately

$$T = 2\pi r^2 \mu p l,$$

where r and p are defined above,

T = torque capacity of the joint,

μ = coefficient of friction at the interface, and

l = length of hub engagement.

Intermediate- and Long-Length Columns

The slenderness ratio of a column is $S_r = l/k$, where l is the length of the column and k is the radius of gyration. The radius of gyration of a column cross-section is, $k = \sqrt{I/A}$

where I is the area moment of inertia and A is the cross-sectional area of the column. A column is considered to be intermediate if its slenderness ratio is less than or equal to $(S_r)_D$, where

$$(S_r)_D = \pi \sqrt{\frac{2E}{S_y}}, \text{ and}$$

E = Young's modulus of respective member, and

S_y = yield strength of the column material.

For intermediate columns, the critical load is

$$P_{cr} = A \left[S_y - \frac{1}{E} \left(\frac{S_y S_r}{2\pi} \right)^2 \right], \text{ where}$$

P_{cr} = critical buckling load,

A = cross-sectional area of the column,

S_y = yield strength of the column material,

E = Young's modulus of respective member, and

S_r = slenderness ratio.

For long columns, the critical load is

$$P_{cr} = \frac{\pi^2 EA}{S_r^2}$$

where the variable area as defined above.

For both intermediate and long columns, the effective column length depends on the end conditions. The AISC recommended values for the effective lengths of columns are, for: rounded-rounded or pinned-pinned ends, $l_{eff} = l$; fixed-free, $l_{eff} = 2.1l$; fixed-pinned, $l_{eff} = 0.80l$; fixed-fixed, $l_{eff} = 0.65l$. The effective column length should be used when calculating the slenderness ratio.

Gearing

Gear Trains: *Velocity ratio*, m_v , is the ratio of the output velocity to the input velocity. Thus, $m_v = \omega_{out} / \omega_{in}$. For a two-gear train, $m_v = -N_{in} / N_{out}$ where N_{in} is the number of teeth on the input gear and N_{out} is the number of teeth on the output gear. The negative sign indicates that the output gear rotates in the opposite sense with respect to the input gear. In a *compound gear train*, at least one shaft carries more than one gear (rotating at the same speed). The velocity ratio for a compound train is:

$$m_v = \pm \frac{\text{product of number of teeth on driver gears}}{\text{product of number of teeth on driven gears}}$$

A *simple planetary gearset* has a sun gear, an arm that rotates about the sun gear axis, one or more gears (planets) that rotate about a point on the arm, and a ring (internal) gear that is concentric with the sun gear. The planet gear(s)

mesh with the sun gear on one side and with the ring gear on the other. A planetary gearset has two, independent inputs and one output (or two outputs and one input, as in a differential gearset).

Often, one of the inputs is zero, which is achieved by grounding either the sun or the ring gear. The velocities in a planetary set are related by

$$\frac{\omega_f - \omega_{arm}}{\omega_L - \omega_{arm}} = \pm m_v, \text{ where}$$

ω_f = speed of the first gear in the train,

ω_L = speed of the last gear in the train, and

ω_{arm} = speed of the arm.

Neither the first nor the last gear can be one that has planetary motion. In determining m_v , it is helpful to invert the mechanism by grounding the arm and releasing any gears that are grounded.

Loading on Straight Spur Gears: The load, W , on straight spur gears is transmitted along a plane that, in edge view, is called the *line of action*. This line makes an angle with a tangent line to the pitch circle that is called the *pressure angle* ϕ . Thus, the contact force has two components: one in the tangential direction, W_t , and one in the radial direction, W_r . These components are related to the pressure angle by

$$W_r = W_t \tan(\phi).$$

Only the tangential component W_t transmits torque from one gear to another. Neglecting friction, the transmitted force may be found if either the transmitted torque or power is known:

$$W_t = \frac{2T}{d} = \frac{2T}{mN},$$

$$W_t = \frac{2H}{d\omega} = \frac{2H}{mN\omega}, \text{ where}$$

W_t = transmitted force (newton),

T = torque on the gear (newton-mm),

d = pitch diameter of the gear (mm),

N = number of teeth on the gear,

m = gear module (mm) (same for both gears in mesh),

H = power (kW), and

ω = speed of gear (rad/sec).

Stresses in Spur Gears: Spur gears can fail in either bending (as a cantilever beam, near the root) or by surface fatigue due to contact stresses near the pitch circle. AGMA Standard 2001 gives equations for bending stress and surface stress. They are:

$$\sigma_b = \frac{W_t}{FmJ} \frac{K_a K_m}{K_v} K_s K_B K_I, \text{ bending and}$$

$$\sigma_c = C_p \sqrt{\frac{W_t}{FId} \frac{C_a C_m}{C_v} C_s C_f}, \text{ surface stress, where}$$

σ_b = bending stress,

σ_c = surface stress,

W_t = transmitted load,

F = face width,

m = module,

J = bending strength geometry factor,

K_a = application factor,

K_B = rim thickness factor,

K_I = idler factor,

K_m = load distribution factor,

K_s = size factor,

K_v = dynamic factor,

C_p = elastic coefficient,

I = surface geometry factor,

d = pitch diameter of gear being analyzed, and

C_f = surface finish factor.

C_a , C_m , C_s , and C_v are the same as K_a , K_m , K_s , and K_v , respectively.

INDEX

2

2ⁿ factorial experiments, 145

A

AASHTO, automobile pavement design, 114
AC circuits, 74
AC machines, 134
accelerated cost recovery system (ACRS), 80
acids and bases, 64
activated carbon adsorption, 120
activated sludge, 122
addition, 6
adiabatic humidification (evaporative cooling), 156
adiabatic mixing, 156
adiabatic process, 50
aerobic digestion, 123
air pollution, 124
air refrigeration cycle, 155
air stripping, 121
airport layout and design, 113
algebra of complex numbers, 75
allowable stress design (ASD), steel, 96
anaerobic digester design, 123
analysis of variance for 2ⁿ factorial designs, 146
anode, 64
anode reaction (oxidation), 69
approximations, 143
Archimedes principle and buoyancy, 39
area formulas for surveying, 114
AREA vertical curve criteria for track profile, 112
arithmetic progression, 7
ASHRAE psychrometric chart No. 1, 56
ASTM, 163
ASTM grain size, 71
ASTM standard reinforcing bars, 94
atmospheric dispersion modeling, 124
atomic bonding, 68
atomic number, 64
automobile pavement design, 114
average and range charts, 143
average value, 74
Avogadro's number, 64

B

backwash, 119
bag house filters, 128
balanced three-phase systems, 135
ball/roller bearing selection, 163
banking of curves (without friction), 27
batch reactor, 89
batch reactor constant T and V, 89
beam deflection formulas – special cases, 37
beam design, steel (LRFD, ASD), 97
 allowable moments curves (ASD), 106
 allowable stress S_x table (ASD), 105
 design moments curves (LRFD), 102
 load factor Z_x table (LRFD), 101
beam fixed-end moment formulas, 94
beam-columns, steel, 99
bed expansion, 119
benefit-cost analysis, 80
binary phase diagrams, 69
binomial distribution, 8
bioconcentration factor, 130
biomechanics of the human body, 146
biotower, 123
bipolar junction transistor (BJT), 136, 137
BOD, 117
BOD exertion, 122

boilers, condensers, evaporators, one side in a heat exchanger, 48
boiling point elevation, 64
bolted and riveted joints loaded in shear, 162
bolted connections, steel, 99
 bolt capacity tables, 99
bonds, 80
book value, 79
brake power, 158
brake thermal efficiency, 159
brake-band or belt friction, 23
Brayton cycle (steady-flow cycle), 159
Brayton cycle with regeneration, 160
break-even analysis, 80
break-through time for leachate to penetrate a clay liner, 131

C

cancer slope factor, 129
canonical product of sums (POS), 142
canonical sum of products (SOP), 142
capacitors and inductors, 73
capacitors and inductors in parallel and series, 73
capitalized costs, 80
Carmen-Kozeny equation, 118
catalyst, 64
cathode, 64, 69
centrifugal force, 27
centroids and moments of inertia, 18
centroids of masses, areas, lengths, and volumes, 22
chemical
 reaction engineering, 89
 reaction equilibrium, 88
 thermodynamics, 88
circle, 4
circular sector, 16
circular segment, 16
clarification, 119
clarifier, 119
Clausius' statement of second law, 50
closed thermodynamic system, 47
closed-system availability, 51
column design, steel, 98
 allowable stress table (ASD), 107
 design stress table (LRFD), 104
column effective length KL, 98
 K-values and alignment chart, 103
columns
 concrete design, 95
 Euler's formula, 36
 steel design, 98
combustion
 in air, 50
 in excess air, 50
 incomplete, 50
 processes, 50
common metallic crystal structures, 68
common thermodynamic cycles, 52
communication theory concepts, 135
complex numbers, 5, 75
complex power, 75
composite flip-flop state transition, 142
composite materials, 71
compressible fluid, 43
compression ratio, 159
computer knowledge, 76
concept of weight, 25
concurrent forces, 23
condensation
 outside horizontal tubes, 60
 pure vapor on a vertical surface, 60
conduction, 58
 through a plane wall, 58
conductive heat transfer, 60

confidence interval, 10
 confidence interval for a, 145
 confidence interval for b, 145
 conic section equation, 4
 conic sections, 3
 construction, 114
 continuity equation, 39
 continuous distillation (binary system), 90
 continuous stirred tank reactor (CSTR), 90
 continuous stirred tank reactors in series, 90
 control systems, 77
 convection, 58, 91
 convolution, 135
 cooling and dehumidification, 155
 cooling load, 157
 coordination number, 68
 corollary, 50
 corrosion, 69
 CPM precedence relationships (activity on node), 114
 crest – vertical curve, 110
 critical depth, 109
 critical path method (cpm), 148
 critical values of the F distribution table, 13
 critically damped, 18, 78
 crystallography, 68
 current, 72
 curvature in rectangular coordinates, 14
 curvature of any curve, 14
 cyclone 50% collection efficiency for particle diameter, 128
 cyclone collection efficiency, 128
 cyclone separator, 128
 cylindrical pressure vessel, 33

D

daily dose, 130
 Darcy's equation, 108
 data quality objectives (DQO) for sampling soils and solids, 131
 DC machines, 134
 deflection of beams, 36
 deflection of trusses and frames, 94
 deflectors and blades, 42
 DeMorgan's theorem, 141
 density, specific volume, specific weight, and specific gravity, 38
 depreciation, 80
 depth of sorption zone, 120
 derivative, 14
 derivatives and indefinite integrals, 15
 design criteria for sedimentation basins, 119
 design data for clarifiers for activated-sludge systems, 119
 design of experiments one-way anova table, 149
 determinants, 6
 determined from the noncarcinogenic dose-response curve using NOAEL, 130
 Deutsch equation, 129
 diesel cycle, 158
 difference equations, 19
 differential (simple or Rayleigh) distillation, 90
 differential calculus, 14
 differential equations, 18
 diffusion, 69, 91
 diffusion coefficient, 69
 digital signal processing, 135
 dimensional homogeneity and dimensional analysis, 44
 dimensionless group equation (Sherwood), 91
 dimensions, 120
 diodes, 137
 discount factors for continuous compounding, 79
 dispersion, mean, median, and mode value, 9
 displacement volume, 159
 distribution, 9
 distillation, 90
 distortion-energy theory, 35
 dose-response curve, 129
 DQO, 131
 drag coefficients for spheres, disks, and cylinders, 46
 drilling, 148
 dual linear program, 143

E

earthwork formulas, 114
 effect of overburden pressure, 131
 effective flange width-concrete t-beams, 95
 effective or RMS values, 74
 effective stack height, 124
 elastic potential energy, 26
 elastic strain energy, 36
 electrochemistry, 64
 electro dialysis, 121
 electromagnetic dynamic fields, 134
 electrostatic fields, 72
 electrostatic precipitator, 129
 electrostatics, 72
 ellipse, 3, 16
 endurance limit, 161
 endurance limit modifying factors, 161
 endurance test, 70
 energy conversion and power plants, 158
 energy line (Bernoulli equation), 40
 engineering strain, 33
 enhancement MOSFET (low and medium frequency), 140
 entropy, 50
 entropy change for solids and liquids, 51
 environmental engineering, 117
 environmental microbiology, 122
 equilibrium constant of a chemical reaction, 64
 equimolar counter-diffusion (gases), 91
 equipment requirements, 147
 equivalent mass, 64
 ergonomics, 146, 152
 hearing, 153, 154
 essential prime implicant, 142
 Euler's
 formula, 36
 identity, 5
 Euler's approximation, 21
 exposure and intake rates, 129

F

face milling, 148
 facility planning, 147
 facultative pond, 123
 fan characteristics, 157
 fans, pumps, and compressors, 157
 Faraday's law, 64, 72
 fastener groups in shear, 162
 fate and transport, 130
 fatigue loading, 161
 feed condition line, 90
 feedwater heaters, 160
 field equation, 40
 filtration, 118
 first law (energy balance), 48
 first law of thermodynamics, 47
 first-order linear difference equation, 20
 first-order linear nonhomogeneous differential equations, 18
 first-order reaction, 89
 fixed blade, 42
 fixed film, 119
 fixed-film equation with recycle, 123
 fixed-film equation without recycle, 123
 flash (or equilibrium) distillation, 90
 flip-flops, 142
 flocculation, 119
 flow
 in noncircular conduits, 41
 of a real fluid, 40
 open-channel, 109
 parallel to a constant-temperature flat plate, 60
 past a constant-temperature sphere, 60
 perpendicular to axis of a constant-temperature circular cylinder, 60
 flow reactors, steady state, 89
 fluid flow, 40
 fluid measurements, 43

force, 22
 forces on submerged surfaces and the center of pressure, 39
 fouling factor, 59
 Fourier series, 19, 135
 Fourier transform, 19
 four-variable Karnaugh map, 142
 free vibration, 27
 freezing point depression, 64
 Freundlich isotherm, 120
 friction, 23, 26
 friction factor for Laminar flow, 41
 friction factor to predict heat-transfer and mass transfer coefficients, 63
 Froude number, 109
 fundamental constants, 1
 fundamental relationships, 144

G

gain margin, 77
 gamma function, 10
 gas flux, 130
 gas turbines, 159
 Gaussian, 124
 gear trains, 164
 gearing, 164
 general considerations, 76
 geometric progression, 7
 geotechnical definitions, 92
 Gibbs
 free energy, 50
 phase rule, 49, 69
 gradient, divergence, and curl, 7

H

half life of a biologically degraded contaminant assuming first-order rate
 constant, 122
 half-life, 129
 hardenability, 70
 hardness, 70
 hazard index, 130
 Hazen-Williams equation, 42, 110
 head loss through clean bed, 118
 heat
 capacity, 57
 engines, 49
 exchangers, 48
 transfer rate in a tubular heat exchanger, 60
 transfer to/from bodies immersed in a large body of flowing fluid, 60
 heat transfer, 58, 63
 heating and humidification, 156
 heating load, 156
 heats of reaction, 89
 heats of reaction, solution, formation, and combustion, 64
 heat-transfer coefficient, 59
 helical linear springs, 163
 helical torsion springs, 163
 Helmholtz free energy, 50
 Henry's law at constant temperature, 50
 highway, 111
 sag vertical curve criterion for driver or passenger comfort (metric), 112
 spiral curve length (metric), 111
 superelevation (metric), 111
 hollow, thin-walled shafts, 35
 Hooke's law, 34
 horizontal curve formulas, 116
 horizontal velocities, 120
 HVAC – pure heating and cooling, 155
 hydraulic gradient (grade line), 40
 hydraulic-elements graph for circular sewers, 109
 hydrology, 108
 NRCS (SCS) rainfall-runoff, 108
 rational formula, 108
 hyperbola, 3

I

Ideal Gas Law, 47
 ideal gas mixtures, 49
 impact, 26
 impact test, 70
 Impeller mixer, 118
 implicant, 142
 important families of organic compounds, 66
 impulse and momentum, 25
 impulse response, 135
 impulse turbine, 42
 impulse-momentum principle, 25, 41
 incineration, 127
 incomplete combustion, 50
 increase of entropy principle, 50
 indicated power, 159
 indicated thermal efficiency, 159
 induced voltage, 72
 inequality of Clausius, 50
 infiltration, 157
 inflation, 80
 influence lines, 94
 instantaneous center of rotation, 27
 instrumentation, 76
 integral calculus, 14
 interest factor tables, 81–85
 intermediate- and long-length columns, 164
 internal combustion engines, 158
 inventory models, 146
 inverse, 6
 iron-iron carbide phase diagram, 69
 irreversibility, 51
 isentropic process, 50
 isothermal, reversible process, 50

J

jet propulsion, 42
 JFETs, 136, 138
 job sequencing, 148
 junction, 160

K

Karnaugh map (K-Map), 142
 Kelvin-Planck statement of second law, 50
 Kendall notation, 144
 kinematics, 24
 kinetic energy, 25, 27
 kinetics, 25
 Kirchhoff's laws, 73

L

laminar flow, 60
 landfill, 130
 Langmuir isotherm, 120
 Laplace transforms, 19
 laws of probability, 8
 Le Chatelier's principle for chemical equilibrium, 64
 learning curves, 146
 least squares, 145
 length:width ration, 120
 Lever rule, 69
 L'Hospital's rule (L'Hôpital's rule), 14
 licensee's obligation to employer and clients, 87
 licensee's obligation to other licensees, 87
 licensee's obligation to society, 87
 lime-soda softening, 117
 line balancing, 147
 line source attenuation, 129
 linear programming, 143
 linear projection, 117
 linear regression and design of experiments, 145
 liquid metals, 60

load combinations, steel, 96
 load resistance factor design (LRFD), steel, 96
 loading on straight spur gears, 165
 log growth, 117
 log mean temperature difference
 concurrent flow in tubular heat exchangers, 59
 countercurrent flow in tubular heat exchangers, 59
 logarithms, 4
 logic gates, 141
 logic operations and boolean algebra, 141
 longitudinal grade design criteria for runways, 113
 lossless transmission lines, 134

M

Mach number, 43
 machine design, 160
 machining formulas, 148
 magnetic fields, 72
 Manning's equation, 42, 110
 mass
 fraction, 49
 mass transfer in dilute solutions, 63
 mass moment of inertia, 26
 mass transfer, 63, 91
 material handling, 147
 material properties, 36
 material removal rate formulas, 148
 matrices, 6
 maximum normal-stress theory, 34
 maximum rate of change of gradient in percent grade per station, 112
 maximum shear-stress theory, 34
 maximum spacing for stirrups, 95
 maxterm, 142
 maxterm list, 142
 mean effective pressure (mep), 159
 measurement uncertainty, 76
 mechanical
 efficiency, 159
 springs, 163
 median, 9
 mensuration of areas and volumes, 16, 17
 metallic elements, 64
 metric stopping sight distance, 111
 Miller indices, 68
 minimum shear reinforcement, 95
 minor losses in pipe fittings, contractions, and expansions, 41
 minterm, 142
 minterm list, 142
 miscellaneous effects factor, k_e , 161
 Model Rules of Professional Conduct, 86
 modified ACRS factors, 80
 modified Davis equation – railroads, 112
 modified Goodman theory, 160
 Mohr's Circle – stress, 2D, 34
 molar volume, 64
 molarity
 solutions, 64
 mole fraction of a substance, 64
 molecular diffusion, 91
 moment
 capacity, steel beams, 97
 capacity-concrete T-beams, 95
 design-concrete design, 95
 inertia transfer theorem, 23
 moment of inertia, 22
 moments (couples), 22
 momentum transfer, 63
 momentum, heat and mass transfer analogy, 63
 Monod Kinetics, 122
 Moody (Stanton) diagram, 45
 MOSFETs, 136, 138, 140
 moving average, 145
 moving blade, 42
 multipath pipeline problems, 42
 multiple server model ($s > 1$), 144
 multiplication, 6

Murphree plate efficiency, 90

N

natural (free) convection, 61
 NCEES *Model Rules of Professional Conduct*, 86
 N-channel junction field effect transistors (JFET's), 138
 Newton's method of minimization, 20
 Newton's method of root extraction, 20
 NOAEL, 129
 noise pollution, 129
 nomenclature, 16, 47
 nomenclature and definitions, 79
 non-annual compounding, 79
 non-metallic elements, 64
 normal depth, 110
 normal distribution, 9
 normality of solutions, 64
 nozzles, diffusers, 48
 NPN bipolar junction transistor (BJT), 137
 NRCS (SCS) rainfall-runoff, 108
 number of atoms in a cell, 68
 number systems and codes, 141
 numerical integration, 21
 numerical methods, 20
 numerical solution of ordinary differential equations, 21

O

octanol-water partition coefficient, 130
 one-dimensional flows, 39
 one-dimensional motion of particle, 25
 one-way analysis of variance (anova), 145
 open thermodynamic system, 48
 open-channel flow and/or pipe flow, 42, 109
 open-system availability, 51
 operating lines, 90
 operational amplifiers, 74
 organic carbon partition coefficient K_{oc} , 130
 orifice
 discharge freely into atmosphere, 44
 submerged, 43
 orifices, 43
 osmotic pressure of solutions of electrolytes, 120
 Otto Cycle, 158
 overall heat-transfer coefficient, 59
 overdamped, 78
 overflow rate, 119
 oxidation, 64
 oxidizing agent, 64

P

packing factor, 68
 parabola, 3, 16
 paraboloid of revolution, 17
 parallel
 axis theorem, 26
 resonance, 75
 parallelogram, 17
 partial
 derivative, 14
 pressures, 49
 volumes, 49
 partition coefficients, 130
 people requirements, 147
 periodic table of elements, 65
 permutations and combinations, 8
 pert, 148
P-h diagram for refrigerant HFC-134a, 55
 phase margin, 77
 phase relations, 49
 phasor transforms of sinusoids, 74
 PID controller, 77
 pipe bends, enlargements, and contractions, 41
 pitot tube, 43

plane circular motion, 24
 plane motion of a rigid body, 27
 plane truss, 23
 method of joints, 23
 method of sections, 23
 planning, 117
 plant location, 147
 plug-flow reactor (PFR), 89
 point source attenuation, 129
 polar coordinates, 5
 population projection equations, 117
 possible cathode reactions (reduction), 69
 potential energy, 25
 in gravity field, 26
 power in a resistive element, 73
 power law fluid, 38, 40
 preamble to the NCEES *Model Rules of Professional Conduct*, 86
 press/shrink fits, 164
 pressure field in a static liquid and manometry, 38
 primary, 68
 prime implicant, 142
 principal stresses, 34
 principle of conservation of work and energy, 26
 prismoid, 17
 probability and density functions
 means and variances, 149
 probability and statistics, 8
 probability density functions, 8
 probability distribution functions, 8
 probability functions, 8
 product of inertia, 23
 progressions and series, 7
 projectile motion, 25
 properties of series, 7
 properties of single-component systems, 47
 properties of water, 44
 psychrometric chart, 49, 56
 psychrometrics, 49
 pump, 160
 pump characteristics, 157
 pump power equation, 41

Q

quadratic equation, 3
 quadric surface (sphere), 4
 queueing models, 144

R

radiation, 58, 61
 radiation half-life, 71
 radiation shields, 62
 radius of curvature, 14
 radius of gyration, 23
 railroads, 111
 Raoult's law for vapor-liquid equilibrium, 50
 rapid mix, 118
 rate of heat transfer in a tubular heat exchanger, 60
 rate of transfer
 function of gradients at the wall, 63
 in terms of coefficients, 63
 rate-of-return, 80
 rational formula, 108
 RC and RL transients, 74
 real and paddle, 118
 recommended weight limit (U.S. Customary Units), 146
 rectangular coordinates, 24
 rectifying section, 90
 reducing agent, 64
 reflux ratio, 90
 refrigeration and HVAC, 155
 refrigeration cycles, 49
 regular polygon (n equal sides), 17
 reinforced concrete design, 94
 reinforced concrete design definitions, 95
 reinforcement limits—concrete design, 95

reinforcement ratio—concrete design, 95
 required power, 121
 reradiating surface, 62
 resistivity, 72
 resistors in series and parallel, 73
 resolution of a force, 22
 resonance, 75
 resultant, 22
 retardation factor= R , 130
 reverse osmosis, 120
 Reynolds number, 40, 118, 119
 right circular cone, 17
 right circular cylinder, 17
 risk, 130
 risk assessment, 129
 risk management, 130
 RMS, 74
 roots, 5
 Rose equation, 118
 rotation about a fixed axis, 27
 Routh test, 78
 Rules of Professional Conduct, 86

S

sag, 111
 salt flux through the membrane, 121
 sample, 145
 saturated water - temperature table, 53
 Scaling laws, 157
 screw thread, 23
 screws, fasteners, and connections, 161
 second law of thermodynamics, 50
 second-order control-system models, 78
 second-order linear difference equation, 20
 second-order linear nonhomogeneous differential equations
 with constant coefficients, 18
 second-order reaction, 89
 sensors, types of, 76
 series resonance, 75
 settling equations, 118
 sewage flow ratio curves, 108
 shafts and axles, 161
 shape factor relations, 62
 shear design
 concrete, 95
 steel, 98
 shear stress-strain, 33
 shearing force and bending moment sign conventions, 35
 sight distance related to curve length, 110
 sight distance, crest vertical curves (metric), 112
 sight distance, sag vertical curves (metric), 112
 similitude, 44
 simple planetary gearset, 164
 Simpson's Rule, 21, 114
 sine-cosine relations, 74
 single server models ($s = 1$), 144
 size factor, k_b , 161
 slab milling, 148
 sludge age, 124
 Soderberg theory, 160
 soil landfill cover water balance, 131
 soil-water partition coefficient, 130
 solids residence time, 122
 solid-state electronics and devices, 136
 solubility product constant, 64
 source equivalents, 73
 special cases of closed systems, 48
 special cases of open systems, 48
 special cases of steady-flow energy equation, 48
 specific energy, 109
 specific energy diagram, 110
 specific fuel consumption (sfc), 159
 sphere, 16
 spiral transitions to horizontal curves, 111
 spring material, 163
 square thread power screws, 161

standard deviation charts, 143
 standard error of estimate, 145
 standard oxidation potentials for corrosion reactions, 67
 standard tensile test, 70
 standard time determination, 147
 state functions (properties), 47
 state-variable control-system models, 78
 static loading, 161
 static loading failure theories, 34
 statically determinate truss, 23
 statistical quality control, 143
 steady conduction with internal energy generation, 60
 steady, incompressible flow in conduits and pipes, 41
 steady-state error $e_{ss}(t)$, 77
 steady-state mass balance for aeration basin, 122
 steady-state systems, 48
 steam power plants, 160
 steam trap, 160
 steel design (ASD, LRFD), 96
 Stokes' Law, 118
 stopping sight distance, 110, 111
 straight line, 3, 80
 straight line motion, 25
 stream modeling, 117
 Streeter Phelps, 117
 strength reduction factors-reinforced concrete, 94
 stress and strain, 34
 stress, pressure, and viscosity, 38
 stresses in beams, 35
 stresses in spur gears, 165
 stress-strain curve for mild steel, 33
 stripper packing height = Z , 122
 stripping section, 90
 structural analysis, 94
 subscripts, 79
 superelevation of horizontal curves, 111
 superheated water tables, 54
 surface factor, k_a , 161
 surface tension and capillarity, 38
 surveying, 113
 SVI, 122
 switching function terminology, 142
 systems of forces, 22

T

tabulated characteristics, 136
 tangential and normal components, 24
 tangential and normal kinetics for planar problems, 25
 tank volume, 123
 Taylor Tool life formula, 148
 Taylor's series, 8
 T-beams-concrete design, 95
 t -distribution table, 12
 temperature factor, k_d , 161
 temperature-entropy (T-s) diagram, 51
 tension members, steel, 96
 test

- for a point of inflection, 14
- for maximum, 14
- for minimum, 14

 testing methods, 70
 tests for out of control, 144
 thermal conductivity, 59
 thermal deformations, 33
 thermal energy reservoirs, 50
 thermal processing, 70
 threaded fasteners, 161

- design factors, 162
- fatigue loading, 162

 three dimensions, 23
 throttling valves & throttling processes, 48
 to evaluate surface or intermediate temperatures, 58

torsion, 35
 torsional free vibration, 28
 total material balance, 90
 traffic flow relationships ($q = kv$), 112
 transformers, 75
 transient conduction using the lumped capacitance method, 61
 transportation, 110
 transportation models, 112
 transpose, 6
 transverse and radial components for planar problems, 24
 trapezoidal rule, 21, 114
 trigonometry, 5
 turbines, pumps, compressors, 48
 turbulent flow, 60
 turbulent flow in circular tubes, 63
 turns ratio, 75
 two dimensions, 23
 two work centers, 148
 two-body problem, 61
 two-film theory (for equimolar counter-diffusion), 91
 two-stage cycle, 155
 type of spring ends, 163
 typical fan curves, 157
 typical primary clarifier efficiency percent removal, 119

U

ultimate strength design-reinforced concrete, 94
 ultrafiltration, 121
 underdamped, 78
 uniaxial loading and deformation, 33
 uniaxial stress-strain, 33
 unidirectional diffusion of a gas through a second stagnant gas b ($n_b = 0$), 91
 unified soil classification system, 93
 unit normal distribution table, 11
 units, 72
 unsteady state diffusion in a gas, 91
 US civilian body dimensions, female/male, for ages 20 to 60 years, 152

V

values of $t_{\alpha, n}$, 12
 vapor-liquid equilibrium, 88
 vapor-liquid mixtures, 50
 variable loading failure theories, 160
 vectors, 6
 velocity gradient, 118
 velocity ratio, 164
 venturi meters, 43
 vertical curve formulas, 115
 viscosity, 38
 voltage, 72, 121
 volumetric efficiency, 159

W

water, 117
 water and wastewater technologies, 117
 water, properties, 44
 Weir formulas, 110
 Weir loadings, 120
 wind rose, 113
 work and energy, 25
 work sampling formulas, 148

Z

zero-order reaction, 89
 z -transforms, 20